

TRANSNET

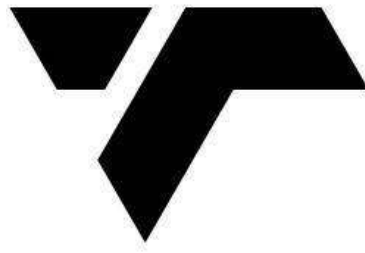

(REGISTRATION NO.1990/000900/06)
TRADING AS
TRANSNET FREIGHT RAIL

ADDENDUM NO. 1 TO THE E 7/1 (JULY 1998)

SPECIFICATION FOR WORKS ON, OVER, UNDER OR ADJACENT TO RAILWAY LINES AND NEAR HIGH VOLTAGE EQUIPMENT.

- Clause 13 Blasting.
Delete this clause in its entirety
- Clause 17 General.
Sub-clause 17.1
Include the words "on request only" after the word "contract" in the fourth line.
- Clause 27 Blasting.
Delete this clause in its entirety



TRANSNET

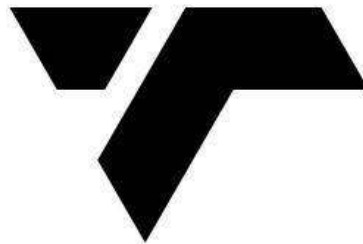

TRANSNET LIMITED
(REGISTRATION NO.1990/000900/06)

E7/1 (July 1998)

SPECIFICATION FOR WORKS ON, OVER, UNDER OR ADJACENT TO RAILWAY LINES AND NEAR
HIGH VOLTAGE EQUIPMENT

(This Specification shall be used in Transnet Contracts)

CONTENTS

<u>CLAUSE</u>	<u>DESCRIPTION</u>	<u>PAGE NO'S</u>
1.	<u>DEFINITIONS</u>	3
	<u>PART A - GENERAL SPECIFICATION</u>	
2.	Authority of officers of Transnet	4
3.	Contractor's representatives	4
4.	Occupations and work permits	4
5.	Speed restrictions and protection	5
6.	Roads on Transnet property	5
7.	Clearances	5
8.	Stacking of material	5
9.	Excavation, shoring, dewatering and drainage	5
10.	Falsework for structures	6
11.	Piling	6
12.	Underground services	6
13.	Blasting	6
14.	Rail trolleys	7
15.	Signal track circuits	7
16.	Penalty for delays to trains	7
	<u>PART B - ADDITIONAL SPECIFICATION FOR WORK NEAR HIGH-VOLTAGE ELECTRICAL EQUIPMENT</u>	
17.	General	8
18.	Work on buildings of fixed structures	8
19.	Work done on or outside of rolling stock, including loading and unloading	8
20.	Use of equipment	9
21.	Carrying and handling material and equipment	9
22.	Precautions to be taken when erecting or removing poles, antennae and trees	10
23.	Use of water	10
24.	Use of construction plant	10
25.	Work performed under dead conditions under cover of a work permit	10
26.	Traction return circuits in rails	11
27.	Blasting	11
28.	High-voltage electrical equipment not maintained and/or operated by Transnet	11
	<u>ANNEXES</u>	
1.	Horizontal clearances 1 065 mm gauge	
2.	Vertical clearances 1 065 mm gauge	
3.	Clearances 610 mm gauge	
4.	Platform clearances	

1 DEFINITIONS

The following definitions shall apply :

Authorised Person. A person whether an employee of Transnet or not, who has been specially authorised to undertake specific duties in terms of Transnet Freight Rail's publication SAFETY INSTRUCTIONS: HIGH-VOLTAGE ELECTRICAL EQUIPMENT, and who holds a certificate or letter of authority to that effect.

Barrier. Any device designed to restrict access to "live" high-voltage electrical equipment.

Bond. A short conductor installed to provide electrical continuity.

Contractor. Any person or organisation appointed by Transnet to carry out work on its behalf.

Dead. Isolated and earthed.

Electrical Officer (Contracts). The person appointed in writing by the responsible Electrical Engineer in Transnet as the person who shall be consulted by the Contractor in all electrical matters to ensure that adequate safety precautions are taken by the Contractor.

Executive Officer. The person appointed by Transnet from time to time as the Executive Officer to act according to the rights and powers held by and obligations placed upon him in terms of the Contract.

High-Voltage. A voltage normally exceeding 1 000 volts.

Live. A conductor is said to be "live" when it is at a potential different from that of the earth or any other conductor of the system of which it forms a part.

Near. To be in such a position that a person's body or the tools he is using or any equipment he is handling may come within 3 metres of live exposed high-voltage electrical equipment.

Occupation. An authorisation granted by Transnet for work to be carried out under specified conditions on, over under or adjacent to railway lines.

Occupation Between Trains. An occupation during an interval between successive trains.

Project Manager. The person or juristic person appointed by Transnet from time to time as the Project Manager to administer the Contract according to the powers and rights held by and obligations placed upon him in terms of the Contract.

Responsible Representative. The responsible person in charge, appointed by a contractor, who has undergone specific training (and holds a certificate) to supervise staff under his control to work on, over, under or adjacent to railway lines and in the vicinity of high-voltage electrical equipment.

Supervisor. The person or juristic person appointed by Transnet from time to time as the Supervisor, to administer the Contractor's performance and execution of the Works according to the powers and rights held by and obligations placed upon the Supervisor in terms of the Contract.

Total Occupation. An occupation for a period when trains are not to traverse the section of line covered by the occupation.

Work on. Work undertaken on or so close to the equipment that the specified working clearances to the live equipment cannot be maintained.

Work Permit. A combined written application and authority to proceed with work on or near dead electrical equipment.

PART A - GENERAL SPECIFICATION

2. AUTHORITY OF OFFICERS OF TRANSNET

- 2.1 The Contractor shall co-operate with the officers of Transnet and shall comply with all instructions issued and restrictions imposed with respect to the Works which bear on the existence and operation of Transnet's railway lines and high-voltage equipment.
- 2.2 Without limiting the generality of the provisions of 2.1, any duly authorised representative of Transnet, having identified himself, may stop the work if, in his opinion, the safe passage of trains or the safety of Transnet assets or any person is affected. **CONSIDERATIONS OF SAFETY SHALL TAKE PRECEDENCE OVER ALL OTHER CONSIDERATIONS.**

3. CONTRACTOR'S REPRESENTATIVES

- 3.1 The Contractor shall nominate Responsible Representatives of whom at least one shall be available at any hour for call-out in cases of emergency. The Contractor shall provide the Supervisor with the names, addresses and telephone numbers of the representatives.
- 3.2 The Contractor guarantees that he has satisfied himself that the Responsible Representative is fully conversant with this specification and that he shall comply with all his obligations in respect thereof.

4. OCCUPATIONS AND WORK PERMITS

- 4.1 Work to be done during total occupation or during an occupation between trains or under a work permit shall be done in a manner decided by the Supervisor and at times to suit Transnet requirements.
- 4.2 The Contractor shall organise the Works in a manner, which will minimise the number and duration of occupations and work permits required.
- 4.3 Transnet will not be liable for any financial or other loss suffered by the Contractor arising from his failure to complete any work scheduled during the period of an occupation or work permit.
- 4.4 The Contractor shall submit to the Supervisor, in writing, requests for occupations or work permits together with details of the work to be undertaken, at least 14 days before they are required. Transnet does not undertake to grant an occupation or work permit for any particular date, time or duration.
- 4.5 Transnet reserves the right to cancel any occupation or work permit at any time before or during the period of occupation or work permit. If, due to cancellation or change in date or time, the Contractor is not permitted to start work under conditions of total occupation or work permit at the time arranged, all costs caused by the cancellation shall be born by the Contractor except as provided for in clauses 4.6 to 4.8.
- 4.6 When the Contractor is notified less than 2 hours before the scheduled starting time that the occupation or work permit is cancelled, he may claim reimbursement of his direct financial losses caused by the loss of working time up to the time his labour and plant are employed on other work, but not exceeding the period of the cancelled occupation or work permit.
- 4.7 When the Contractor is notified less than 2 hours before the schedule starting time, or during an occupation or work permit, that the duration of the occupation or work permit is reduced, he may claim reimbursement of his direct financial losses caused by the loss of working time due to the reduced duration of the occupation or work permit.
- 4.8 Reimbursement the Contractor for any loss of working time in terms of 4.6 and 4.7, shall be subject to his claims being submitted within 14 days of the event with full details of labour and plant

involved, and provided that the Supervisor certifies that no other work on which the labour and plant could be employed was immediately available.

- 4.9 Before starting any work for which an occupation has been arranged, the Contractor shall obtain from the Supervisor written confirmation of the date, time and duration of the occupation.
- 4.10 Before starting any work for which a work permit has been arranged, the Responsible Representative shall read and sign portion C of form No. T.1276 signifying that he is aware of the limits within which work may be undertaken. After the work for which the permit was granted has been completed, or when the work permit is due to be terminated, or if the permit is cancelled after the start, the same person who signed portion C shall sign portion D of the T.1276 form, thereby acknowledging that he is aware that the electrical equipment is to be made "live". The Contractor shall advise all his workmen accordingly.

5. SPEED RESTRICTIONS AND PROTECTION

- 5.1 When speed restrictions are imposed by Transnet because of the Contractor's activities, the Contractor shall organise and carry out his work so as to permit the removal of the restrictions as soon as possible.
- 5.2 When the Supervisor considers protection to be necessary the Contractor shall, unless otherwise agreed, provide all protection including flagmen, other personnel and all equipment for the protection of Transnet's and the Contractor's personnel and assets, the public and including trains. Transnet will provide training free of charge of the Contractor's flagmen and other personnel performing protection duties. The Contractor shall consult with the Supervisor, whenever he considers that protection will be necessary, taking into account the minimum permissible clearances set out in appendixes 1 to 4.
- 5.3 The Contractor shall appoint a Responsible Representative to receive and transmit any instruction, which may be given by Transnet personnel providing protection.

6. ROADS ON TRANSNET PROPERTY

The provision of clause 25 of the E.5, General Conditions of Contract, or clause 23 of the E.5 (MW), General Conditions of Contract for Maintenance Works, shall apply to the use of existing roads on Transnet's property.

7. CLEARANCES

- 7.1 No temporary works shall encroach on the appropriate minimum clearances set out in Annexure 1 BE97-01 Sheets 1,2, 3 and 5 of 5.

8. STACKING OF MATERIAL

- 8.1 The Contractor shall not stack any material closer than 3 m from the centre line of any railway line without prior approval of the Supervisor.

9. EXCAVATION, SHORING, DEWATERING AND DRAINAGE

- 9.1 Unless otherwise approved by the Supervisor any excavation adjacent to a railway line shall not encroach on the hatched area shown in Figure 1.

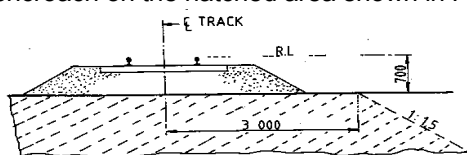

- 9.2 The Contractor shall provide at his own cost any shoring, dewatering or drainage of any excavation unless otherwise stipulated elsewhere in the Contract.
- 9.3 Where required by the Supervisor, drawings of shoring for any excavation under or adjacent to a railway line shall be submitted and permission to proceed obtained, before the excavation is commenced.
- 9.4 The Contractor shall prevent ingress of water to the excavation but where water does enter, he shall dispose of it as directed by the Supervisor.
- 9.5 The Contractor shall not block, obstruct or damage any existing drains either above or below ground level unless he has made adequate prior arrangements to deal with drainage.

10. **FALSEWORK FOR STRUCTURES**

- 10.1 Drawings of falsework for the construction of any structure over, under or adjacent to any railway line shall be submitted to the Supervisor and his permission to proceed obtained before the falsework is erected. Each drawing shall be given a title and a distinguishing number and shall be signed by a registered professional engineer certifying that he has checked the design of the falsework and that the drawings are correct and in accordance with the design.
- 10.2 After the falsework has been erected and before any load is applied, the Contractor shall submit to the Supervisor a certificate signed by a registered professional engineer certifying that he has checked the falsework and that it has been erected in accordance with the drawings. Titles and numbers of the drawings shall be stated in the certificate. Notwithstanding permission given by the Supervisor to proceed, the Contractor shall be entirely responsible for the safety and adequacy of the falsework.

11. **PILING**

- 11.1 The Supervisor will specify the conditions under which piles may be installed on Transnet property.

12. **UNDERGROUND SERVICES**

- 12.1 No pegs or stakes shall be driven or any excavation made before the Contractor has established that there are no underground services, which may be damaged thereby.
- 12.2 Any damage shall be reported immediately to the Supervisor, or to the official in charge at the nearest station, or to the traffic controller in the case of centralised traffic control.

13. **BLASTING**

- 13.1 The provisions of clause 23 of the E.5, General Conditions of Contract or clause 21 of the E.5 (MW), General Conditions of Contract for Maintenance Work, shall apply to all blasting operations undertaken in terms of the Contract.
- 13.2 The Contractor shall provide proof that he has complied with the provisions of clauses 10.17.1 to 10.17.4 of the Explosives Regulations (Act 26 of 1956 as amended).
- 13.3 Blasting within 500m of a railway line will only be permitted during intervals between trains. A person appointed by the Supervisor, assisted by flagmen with the necessary protective equipment, will be in communication with the controlling railway station. Only this person will be authorised to give the Contractor permission to blast, and the Contractor shall obey his instructions implicitly regarding the time during which blasting may take place.
- 13.4 The flagmen described in 13.3, where provided by Transnet, are for the protection of trains and Transnet property only, and their presence does not relieve the Contractor in any manner of his

responsibilities in terms of Explosives Act or Regulations, or any obligation in terms of this Contract.

13.5 The person described in 13.3 will record in a book provided and retained by Transnet the dates and times -

- (i) when each request is made by him to the controlling station for permission to blast;
- (ii) when blasting may take place;
- (iii) when blasting actually takes place; and
- (iv) when he advises the controlling station that the line is safe for the passage of trains.

13.6 Before each blast the Contractor shall record in the same book, the details of the blast to be carried out. The person appointed by the Supervisor and the person who will do the blasting shall both sign the book whenever an entry described in 13.5 is made.

13.7 The terms of clause 27 hereof shall be strictly adhered to.

14. **RAIL TROLLEYS**

14.1 The use of rail trolleys or trestle trolleys on a railway line for working on high voltage equipment will be permitted only if approved by the Supervisor and under the conditions stipulated by him.

14.2 All costs in connection with such trolley working requested by the Contractor shall, unless otherwise agreed, be borne by the Contractor, excluding the costs of any train protection services normally provided free of charge by Transnet.

15. **SIGNAL TRACK CIRCUITS**

15.1 Where signal track circuits are installed, the Contractor shall ensure that no material capable of conducting an electrical current makes contact between rails of a railway line/lines.

15.2 No signal connections on track-circuited tracks shall be severed without the Supervisor's knowledge and consent.

16. **PENALTY FOR DELAYS TO TRAINS**

16.1 If any trains are delayed by the Contractor and the Supervisor is satisfied that the delay was avoidable, a penalty will be imposed on the Contractor of R5 000 per hour or part thereof for the period of delay, irrespective of the number of trains delayed.

PART B - ADDITIONAL SPECIFICATION FOR WORK NEAR HIGH-VOLTAGE ELECTRICAL EQUIPMENT**17. GENERAL**

- 17.1 This specification is based on the contents of Transnet Freight Rail's publication SAFETY INSTRUCTIONS, HIGH-VOLTAGE ELECTRICAL EQUIPMENT, as amended, a copy of which will be made available on loan to the Contractor for the duration of the contract. These instructions apply to all work near live high-voltage equipment maintained and/or operated by Transnet, and the onus rests on the Contractor to ensure that he obtains a copy.
- 17.2 The Contractor's attention is drawn in particular to the contents of Part I, Sections 1 and 2 of the Safety Instructions : High-Voltage Electrical Equipment.
- 17.3 The Safety Instructions : High-Voltage Electrical Equipment cover the minimum safety precautions which must be taken to ensure safe working on or near high-voltage electrical equipment, and must be observed at all times. Should additional safety measures be considered necessary because of peculiar local conditions, these may be ordered by and at the discretion of the Electrical Officer (Contracts).
- 17.4 This specification must be read in conjunction with and not in lieu of the Safety Instructions : High-Voltage Electrical Equipment.
- 17.5 The Contractor shall obtain the approval of the Electrical Officer (Contracts) before any work is done which causes or could cause any portion of a person's body or the tools he is using or any equipment he is handling, to come within 3 metres of any live high-voltage equipment.
- 17.6 The Contractor shall regard all high-voltage equipment as live unless a work permit is in force.
- 17.7 Safety precautions taken or barriers erected shall comply with the requirements of the Electrical Officer (Contracts), and shall be approved by him before the work to be protected is undertaken by the Contractor. The Contractor shall, unless otherwise agreed, bear the cost of the provision of the barriers and other safety precautions required, including the attendance of Transnet staff where this is necessary.
- 17.8 No barrier shall be removed unless authorised by the Electrical Officer (Contracts).

18. WORK ON BUILDINGS OR FIXED STRUCTURES

- Before any work is carried out or measurements are taken on any part of a building, fixed structure or earthworks of any kind above ground level situated within 3 metres of live high-voltage equipment, the Electrical Officer (Contracts) shall be consulted to ascertain the conditions under which the work may be carried out.
- 18.2 No barrier erected to comply with the requirements of the Electrical Officer (Contracts) shall be used as temporary staging or shuttering for any part of the Works.
- 18.3 The shuttering for bridge piers, abutments, retaining walls or parapets adjacent to or over any track may be permitted to serve as a barrier, provided that it extends at least 2,5 metres above any working level in the case of piers, abutments and retaining walls and 1,5 metres above any working level in the case of parapets.

19. WORK DONE ON OR OUTSIDE OF ROLLING STOCK, INCLUDING LOADING OR UNLOADING

- 19.1 No person shall stand, climb or work whilst on any platform, surface or foothold higher than the normal unrestricted places of access, namely -
- (i) the floor level of trucks;

- (ii) external walkways on diesel, steam and electric locomotives, steam heat vans, etc. and
- (iii) walkways between coaches and locomotives.

When in these positions, no person may raise his hands or any equipment or material he is handling above his head.

- 19.2 In cases where the Contractor operates his own rail mounted equipment, he shall arrange for the walkways on this plant to be inspected by the Electrical Officer (Contracts) and approved, before commencement of work.
- 19.3 The handling of long lengths of material such as metal pipes, reinforcing bars, etc should be avoided, but if essential they shall be handled as nearly as possible in a horizontal position below head height.
- 19.4 The Responsible Representative shall warn all persons under his control of the danger of being near live high-voltage equipment, and shall ensure that the warning is fully understood.
- 19.5 Where the conditions in 19.1 to 19.3 cannot be observed the Electrical Officer (Contracts), shall be notified. He will arrange for suitable Safety measures to be taken. The Electrical Officer (Contracts), may in his discretion and in appropriate circumstances, arrange for a suitable employee of the Contractor to be specially trained by Transnet Freight Rail and at its costs, as an Authorised Person to work closer than 3 metres from live overhead conductors and under such conditions as may be imposed by the Senior responsible Electrical Engineer in Transnet.

20. USE OF EQUIPMENT

20.1 Measuring Tapes and Devices

20.1.1 Measuring tapes may be used near live high-voltage equipment provided that no part of any tape or a person's body comes within 3 metres of the live equipment.

20.1.2 In windy conditions the distance shall be increased to ensure that if the tape should fall it will not be blown nearer than 3 metres from the live high-voltage equipment.

20.1.3 Special measuring devices longer than 2 metres such as survey staves and rods may be used if these are of non-conducting material and approved by the responsible Electrical Engineer in Transnet, but these devices must not be used within 3 metres of live high-voltage equipment in rainy or wet conditions.

20.1.4 The assistance of the Electrical Officer (Contracts) shall be requested when measurements within the limits defined in 20.1.1 to 20.1.3 are required.

20.1.5 The restrictions described in 20.1.1 to 20.1.3 do not apply on a bridge deck between permanent parapets nor in other situations where a barrier effectively prevents contact with the live high-voltage equipment.

20.2 Portable Ladders

20.2.1 Any type of portable ladder longer than 2 metres may only be used near live high-voltage equipment under the direct supervision of the Responsible Representative. He shall ensure that the ladder is always used in such a manner that the distance from the base of the ladder to any live high-voltage equipment is greater than the fully extended length of the ladder plus 3 metres. Where these conditions cannot be observed, the Electrical Officer (Contracts) shall be advised, and he will arrange for suitable safety measures to be taken.

21. CARRYING AND HANDLING MATERIAL AND EQUIPMENT

21.1 Pipes, scaffolding, iron sheets, reinforcing bars and other material, which exceeds 2 metres in

length, shall be carried completely below head height near live high-voltage equipment. For maximum safety two or more persons so as to maintain it as nearly as possible in a horizontal position should carry such material. The utmost care must be taken to ensure that no part of the material comes within 3 metres of any live high-voltage equipment.

21.2 Long lengths of wire or cable shall never be run out in conditions where a part of a wire or cable can come within 3 metres of any live high-voltage equipment unless the Electrical Officer (Contracts) has been advised and has approved appropriate safety precautions.

21.3 The presence of overhead power lines shall always be taken account of especially when communications lines or cables or aerial cables, stay wires, etc. are being erected above ground level.

22. **PRECAUTIONS TO BE TAKEN WHEN ERECTING OR REMOVING POLES, ANTENNAE, TREES ETC.**

22.1 A pole may be handled for the purpose of erection or removal near high-voltage equipment under the following conditions:

- (i) If the distance between the point at which the pole is to be erected or removed and the nearest live high-voltage equipment is more than the length of the pole plus 3 metres, the work shall be supervised by the Responsible Representative.
- (ii) If the distance described in (i) is less than the length of the pole plus 3 metres, the Electrical Officer (Contracts) shall be consulted to arrange for an Authorised Person to supervise the work and to ensure that the pole is earthed where possible. The pole shall be kept in contact with the point of erection, and adequate precautions shall be taken to prevent contact with live high-voltage equipment.

22.2 The cost of supervision by an Authorised Person and the provision of earthing shall, unless otherwise agreed, be borne by the Contractor.

22.3 The provisions of clauses 22.1 and 22.2 shall also apply to the erection or removal of columns, antennae, trees, posts, etc.

23. **USE OF WATER**

23.1 No water shall be used in the form of a jet if it can make contact with any live high-voltage equipment or with any person working on such equipment.

24. **USE OF CONSTRUCTION PLANT**

24.1 "Construction plant" entails all types of plant including cranes, piling frames, boring machines, excavators, draglines, dewatering equipment and road vehicles with or without lifting equipment.

24.2 When work is being undertaken in such a position that it is possible for construction plant or its load to come within 3 metres of live high-voltage equipment, the Electrical Officer (Contracts) shall be consulted. He will arrange for an Authorised Person to supervise the work and to ensure that the plant is adequately earthed. The Electrical Officer (Contracts) will decide whether further safety measures are necessary.

24.3 The cost of any supervision by an Authorised Person and the provision of earthing shall, unless otherwise agreed, be borne by the Contractor.

24.4 When loads are handled by cranes, non-metallic rope hand lines shall be used, affixed to such loads so as to prevent their swinging and coming within 3 metres of live high-voltage equipment.

24.5 Clauses 24.1 to 24.4 shall apply mutatis mutandis to the use of maintenance machines of any nature.

25. WORK PERFORMED UNDER DEAD CONDITIONS UNDER COVER OF A WORK PERMIT

25.1 If the Responsible Representative finds that the work cannot be done in safety with the high-voltage electrical equipment live, he shall consult the Electrical Officer (Contracts) who will decide on the action to be taken.

25.2 If a work permit is issued the Responsible Representative shall -

- (i) before commencement of work ensure that the limits within which work may be carried out have been explained to him by the Authorised Person who issued the permit to him, and that he fully understands these limits.
- (ii) sign portion C of the permit before commencement of work;
- (iii) explain to all persons under his control the limits within which work may be carried out, and ensure that they fully understand these limits;
- (iv) care for the safety of all persons under his control whilst work is in progress; and
- (v) withdraw all personnel under his control from the equipment on completion of the work before he signs portion D of the work permit.

26. TRACTION RETURN CIRCUITS IN RAILS

26.1 DANGEROUS CONDITIONS CAN BE CREATED BY REMOVING OR SEVERING ANY BOND.

26.2 Broken rails with an air gap between the ends, and joints, at which fishplates are removed under "broken bond" conditions, are potentially lethal. The rails on either side of an air gap between rail ends on electrified lines shall not be touched simultaneously until rendered safe by Transnet personnel.

26.3 The Contractor shall not break any permanent bonds between rails or between rails and any structure. He shall give the Supervisor at least 7 days written notice when removal of such bonds is necessary.

26.4 No work on the track which involves interference with the traction return rail circuit either by cutting or removing the rails, or by removal of bonds shall be done unless the Electrical Officer (Contracts) is consulted. He will take such precautions as may be necessary to ensure continuity of the return circuit before permitting the work to be commenced.

27. BLASTING

27.1 The Contractor shall obtain the permission of the Electrical Officer (Contracts) before blasting, and shall give at least 14 days notice of his intention to blast.

27.2 No blasting shall be done in the vicinity of electrified lines unless a member of Transnet's electrical personnel is present.

27.3 The terms of clause 13 hereof shall be strictly adhered to.

28. HIGH-VOLTAGE ELECTRICAL EQUIPMENT NOT MAINTAINED AND/OR OPERATED BY TRANSNET

Where the work is undertaken on or near high-voltage electrical equipment which is not maintained and/or operated by Transnet, the Occupational Health and Safety Act No. 85 of 1993, and Regulations and Instructions, or the Mines Health and Safety Act (Act 29 of 1996), shall apply.

Such equipment includes: -

- (i) Eskom and municipal equipment;
- (ii) the Contractor's own power supplies; and
- (iii) electrical equipment being installed but not yet taken over from the Contractor.

PREVIEW COPY ONLY

ANNEXURE 1
SHEET 1 of 5
AMENDMENT

HORIZONTAL CLEARANCES :
1 065mm TRACK GAUGE

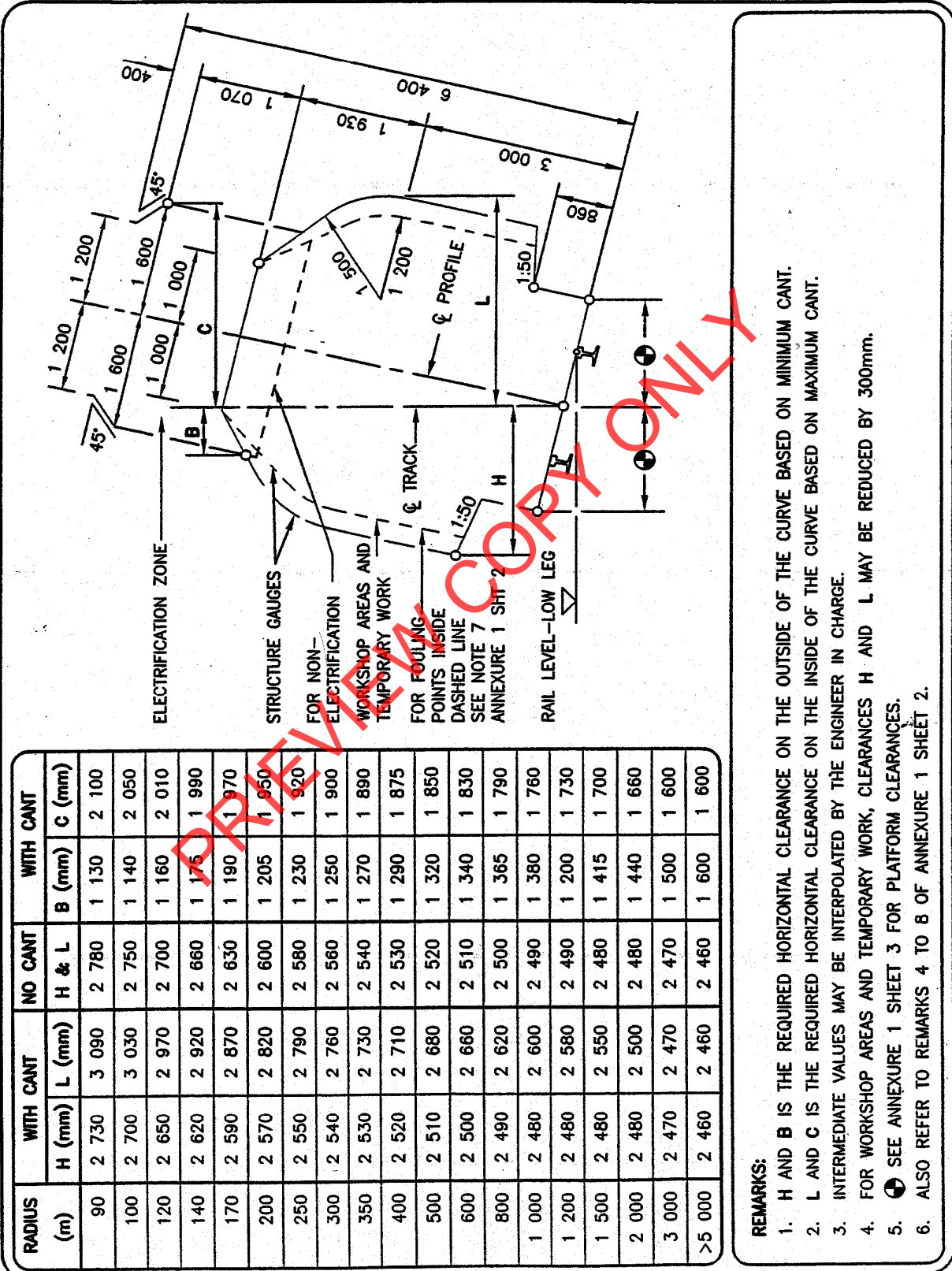

RADIUS (m)	WITH CANT		NO CANT		WITH CANT	
	H (mm)	L (mm)	H & L	B (mm)	C (mm)	
90	2 730	3 090	2 780	1 130	2 100	
100	2 700	3 030	2 750	1 140	2 050	
120	2 650	2 970	2 700	1 160	2 010	
140	2 620	2 920	2 660	1 175	1 990	
170	2 590	2 870	2 630	1 190	1 970	
200	2 570	2 820	2 600	1 205	1 950	
250	2 550	2 790	2 580	1 230	1 920	
300	2 540	2 760	2 560	1 250	1 900	
350	2 530	2 730	2 540	1 270	1 890	
400	2 520	2 710	2 530	1 290	1 875	
500	2 510	2 680	2 520	1 320	1 850	
600	2 500	2 660	2 510	1 340	1 830	
800	2 490	2 620	2 500	1 365	1 790	
1 000	2 480	2 600	2 490	1 380	1 760	
1 200	2 480	2 580	2 490	1 200	1 730	
1 500	2 480	2 550	2 480	1 415	1 700	
2 000	2 480	2 500	2 480	1 440	1 660	
3 000	2 470	2 470	2 470	1 500	1 600	
>5 000	2 460	2 460	2 460	1 600	1 600	

- REMARKS:
1. H AND B IS THE REQUIRED HORIZONTAL CLEARANCE ON THE OUTSIDE OF THE CURVE BASED ON MINIMUM CANT.
 2. L AND C IS THE REQUIRED HORIZONTAL CLEARANCE ON THE INSIDE OF THE CURVE BASED ON MAXIMUM CANT.
 3. INTERMEDIATE VALUES MAY BE INTERPOLATED BY THE ENGINEER IN CHARGE.
 4. FOR WORKSHOP AREAS AND TEMPORARY WORK, CLEARANCES H AND L MAY BE REDUCED BY 300mm.
 5. ⚡ SEE ANNEXURE 1 SHEET 3 FOR PLATFORM CLEARANCES.
 6. ALSO REFER TO REMARKS 4 TO 8 OF ANNEXURE 1 SHEET 2.

BE 97-01 Sht 1 of 5 DATE : JUNE 2000



ANNEXURE 1
SHEET 2 of 5
AMENDMENT

VERTICAL CLEARANCES :
1 065mm TRACK GAUGE

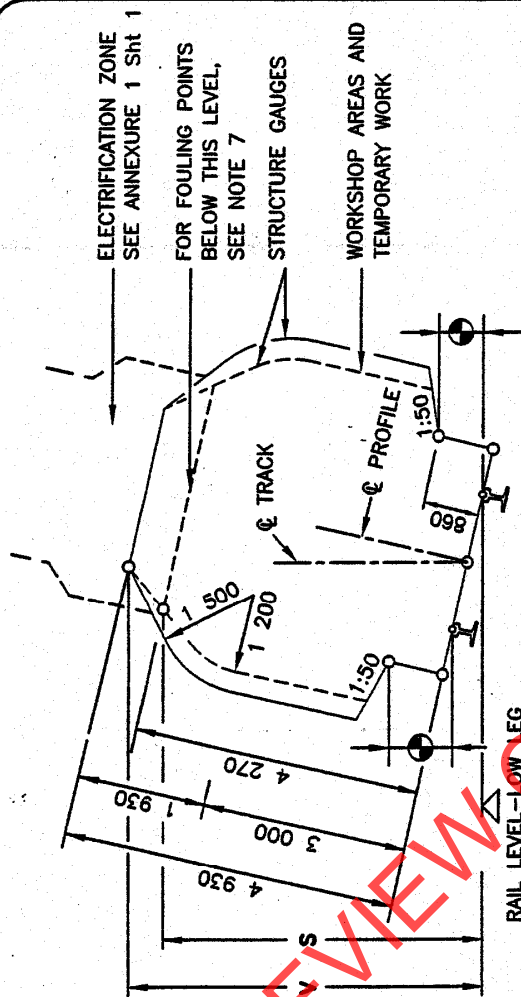

LOCATION	RADIUS (mm)	ELECTRIFIED (PRESENT OR FUTURE)	
		3KV & 25KV V (mm)	50KV V (mm)
* BELOW * ALL AREAS OTHER THAN THOSE INDICATED BY	100	4 470	5 400
	300	4 410	5 370
	600	4 370	5 350
	1 000	4 350	5 340
	1 500	4 310	5 310
	2 000	4 290	5 290
	>3 000	4 270	5 280
* OVER OR NEAR POINTS AND CROSSING IF REQUIRED BY ELECTRICAL IRRESPECTIVE OF RADIUS		5 650	6 000

REMARKS:

1. V IS THE REQUIRED VERTICAL CLEARANCE EXCEPT WHERE REDUCED CLEARANCE S APPLIES.
2. S IS THE MINIMUM VERTICAL CLEARANCE FOR STRUCTURES AND TEMPORARY WORK OVER NON-ELECTRIFIED LINES.
3. INTERMEDIATE VALUES MAY BE INTERPOLATED BY THE ENGINEER IN CHARGE.
4. FOR APPLICATION AT CURVES
 - 4.1 APPLY INCREASED CLEARANCES FOR CURVES TO POINTS 3m BEYOND THE ENDS OF THE CIRCULAR CURVE.
 - 4.2 REDUCE CLEARANCES AT A UNIFORM RATE OVER THE REMAINDER OF THE TRANSITION CURVE.
 - 4.3 FOR NON-TRANSITIONED CURVES REDUCE AT A UNIFORM RATE OVER A LENGTH OF 15m ALONG STRAIGHTS.
5. NEW STRUCTURES: SEE BRIDGE CODE.
6. TUNNELS: SEE DRAWING BE 82-35.
7. FOULING POINTS: SEE CLAUSE 8.1.
8. CLEARANCES ARE BASED ON 15m BOGIE CENTRES AND 21,2m VEHICLE BODY LENGTH.
9. SEE ANNEXURE 1 SHEET 3 FOR PLATFORM CLEARANCES.

BE 97-01 Sht 2 of 5 DATE : JUNE 2000

ANNEXURE 1
SHEET 3 of 5
AMENDMENT

CLEARANCES : PLATFORMS

PLATFORMS : TRACK GAUGE 1 065mm

PASSENGERS

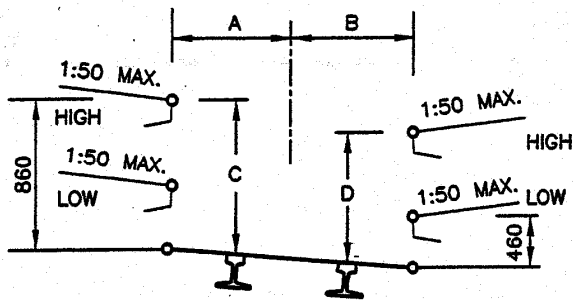

GOODS

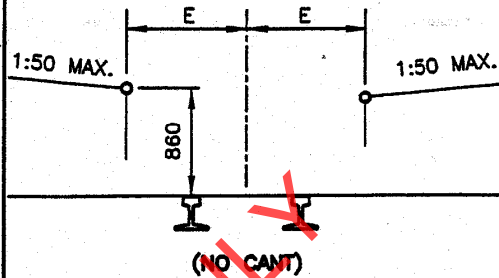

RADIUS (m)	A (mm)	B (mm)	C (mm)	D (mm)	E (mm)
90	1 690	1 820	890	810	1 840
100	1 650	1 790	890	810	1 810
120	1 610	1 740	890	810	1 760
140	1 580	1 700	890	810	1 720
170	1 550	1 660	890	810	1 690
200	1 530	1 630	890	820	1 670
250	1 520	1 600	890	820	1 640
300	1 520	1 580	890	830	1 620
350	1 520	1 560	880	830	1 600
400	1 520	1 550	880	840	1 590
500	1 520	1 540	880	850	1 580
600	1 520	1 530	870	850	1 570
800	1 520	1 520	860	860	1 560
1 200	1 520	1 520	860	860	1 550
2 000	1 520	1 520	860	860	1 540
3 000	1 520	1 520	860	860	1 530
STRAIGHT	1 520	1 520	860	860	1 520

REMARKS:

1. NO CANT TO BE APPLIED EXCEPT WHEN THE GOODS PLATFORM IS ON A RUNNING LINE.
2. INTERMEDIATE VALUES MAY BE INTERPOLATED BY THE ENGINEER IN CHARGE.
3. 8m TO MAIN STATION-BUILDINGS AND 3m TO ALL OTHER STRUCTURES.
4. TOLERANCES : SEE CLAUSE 8.0.10.

STRUCTURES ON PLATFORMS : 1 065mm AND 610mm TRACK GAUGE

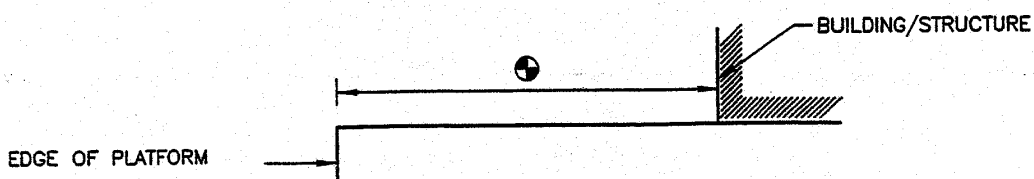

BE 97-01 Sht 3 of 5 DATE : JUNE 2000

ANNEXURE 1
SHEET 5 of 5
AMENDMENT

CLEARANCES : 610mm TRACK GAUGE

RADIUS (m)	F (mm)
50	1 550
60	1 510
80	1 460
100	1 430
120	1 410
140	1 390
170	1 380
200	1 370
250	1 360
300	1 350
600	1 330
1 000	1 320
>2 000	1 320
STRAIGHT	1 310

RADIUS (m)	WITH CANT		NO CANT		V (mm)
	H (mm)	L (mm)	H & L (mm)	H & L (mm)	
50	2 370	2 490	2 400	2 400	4 320
70	2 310	2 420	2 330	2 330	4 310
100	2 260	2 370	2 280	2 280	4 310
140	2 220	2 340	2 250	2 250	4 310
200	2 200	2 300	2 220	2 220	4 300
300	2 190	2 270	2 200	2 200	4 300
500	2 180	2 230	2 190	2 190	4 290
700	2 170	2 200	2 180	2 180	4 270
1 000	2 170	2 170	2 170	2 170	4 270
>2 000	2 160	2 160	2 160	2 160	4 270

REMARKS:

1. H IS THE MINIMUM HORIZONTAL CLEARANCE ON THE OUTSIDE OF THE CURVE BASED ON MINIMUM CANT.
2. L IS THE MINIMUM HORIZONTAL CLEARANCE ON THE INSIDE OF THE CURVE BASED ON MAXIMUM CANT.
3. V IS THE MINIMUM VERTICAL CLEARANCE.
4. FOR APPLICATION AT CURVES:
 - 4.1 APPLY INCREASED CLEARANCES FOR CURVES TO POINTS 2m BEYOND THE ENDS OF THE CIRCULAR CURVE.
 - 4.2 REDUCE CLEARANCES AT A UNIFORM RATE OVER THE REMAINDER OF THE TRANSITION CURVE.
 - 4.3 FOR NON-TRANSITIONED CURVES REDUCE AT A UNIFORM RATE OVER A LENGTH OF 18m ALONG STRAIGHTS.
5. INTERMEDIATE VALUES MAY BE INTERPOLATED BY THE ENGINEER IN CHARGE.
6. ALSO REFER TO REMARKS 5, 6 AND 7 OF ANNEXURE 1 SHEET 2.
7. CLEARANCES ARE BASED ON 9 700mm BOGIE CENTRES AND 13 700mm VEHICLE BODY LENGTH.
8. SEE ANNEXURE 1 SHEET 3 FOR STRUCTURES ON PLATFORMS.

BE 97-01 Sht 5 of 5 DATE : JUNE 2000