

**TRANSNET**



*freight rail*

A Division of Transnet SOC Limited Registration number 1990/00900/30

**RFQ: KBY/52939**

**PEDB: KBC/14105**

SUPPLY, DELIVER AND INSTALL NEW SIGNAL POWER  
EQUIPMENT ON THE POSTMASBURG TO MAMATHANE  
SECTION AND ALSO ON THE WARRENTON – KAMFERSDAM  
SECTION

Senior Buyer  
Supply Chain Services  
TRANSNET FREIGHT RAIL  
Austen Street  
KIMBERLEY  
8301



**TRANSNET FREIGHT RAIL**, a division of

**TRANSNET SOC LTD**

Registration Number 1990/000900/30

[Hereinafter referred to as **Transnet**]

**REQUEST FOR QUOTATION [RFQ] No 52939**

**FOR THE SUPPLY, DELIVER AND INSTALL NEW SIGNAL POWER EQUIPMENT ON  
POSTMASBURG TO MAMATHANE SECTION AND ALSO ON  
THE WARRENTON – KAMFERSDAM SECTION**

**FOR DELIVERY TO: RAIL NETWORK**

**ISSUE DATE: 19 MAY 2014**

**CLOSING DATE: 17 JUNE 2014**

**CLOSING TIME: 10:00**

**SITE MEETING: 4 JUNE 2014**

**Section 1**  
**NOTICE TO BIDDERS**

---

Quotations which must be completed as indicated in Section 2 of this RFQ are to be submitted as follows:

**METHOD:** Hand delivery/courier  
**CLOSING VENUE:** The Tender box, room 1, Supply Chain Services Office, Real Estate Management Building, Austen Street, Beaconsfield, Kimberley, 8315

---

**1 Responses to RFQ**

Responses to this RFQ [**Quotations**] must not include documents or reference relating to any other quotation or proposal. Any additional conditions must be embodied in an accompanying letter.

**2 Broad-Based Black Economic Empowerment [B-BBEE]**

Transnet fully endorses and supports the Government's Broad-Based Black Economic Empowerment Programme and it would therefore prefer to do business with local business enterprises who share these same values. Transnet will accordingly allow a "preference" to companies who provide a valid B-BBEE Verification Certificate. All procurement transactions will be evaluated accordingly.

**2.1 B-BBEE Scorecard and Rating**

As prescribed in terms of the Preferential Procurement Policy Framework Act (PPPFA), Act 5 of 2000 and its Regulations, Respondents are to note that the following preference point system is applicable to all bids:

- the 90/10 system for requirements with a Rand value less than R1 000 000 (all applicable taxes included).
- Bidders are to note that if the 80/20 preference point system is stipulated in this RFP and if all Bids received exceed R1 000 000.00, the RFP must be cancelled.

The value of this bid is estimated to be below R 1 000 000.00 (all applicable taxes included) and therefore the **90/10** system shall be applicable.

When Transnet invites prospective suppliers to submit Proposals for its various expenditure programmes, it requires Respondents to have their B-BBEE status verified in compliance with the Codes of Good Practice issued in terms of the Broad Based Black Economic Empowerment Act No. 53 of 2003.

The Department of Trade and Industry recently revised the Codes of Good Practice on 11 October 2013 [Government Gazette No. 36928]. The Revised Codes will replace the Black Economic Empowerment Codes of Good Practice issued on 9 February 2007. The Revised Codes provide for a one year transitional period starting 11 October 2013. During the transitional period, companies may elect to be measured in terms of the Revised Codes or the 2007 version of the Codes. After the first year of the implementation of the Revised Codes, B-BBEE compliance will be measured in terms of the Revised Codes without any discretion. Companies which are governed by Sector-specific Codes will be measured in terms of those Sector Codes.

As such, Transnet will accept B-BBEE certificates issued based on the Revised Codes. Transnet will also continue to accept B-BBEE certificates issued in terms of the 2007 version of the Codes provided it was issued before 10 October 2014. Thereafter, Transnet will only accept B-BBEE certificates issued based on the Revised Codes.

Respondents are required to complete Annexure A [the B-BBEE Preference Point Claim Form] and submit it together with proof of their B-BBEE Status as stipulated in the Claim Form in order to obtain preference points for their B-BBEE status.

**Note: Failure to submit a valid and original B-BBEE certificate or a certified copy thereof at the Closing Date of this RFQ will result in a score of zero being allocated for B-BBEE.**

*[Refer clause 19 below for Returnable Documents required]*

### **3 Communication**

a) Respondents are warned that a response will be liable for disqualification should any attempt be made by a Respondent either directly or indirectly to canvass any officer(s) or employee of Transnet in respect of this RFQ between the closing date and the date of the award of the business.

b) A Respondent may, however, before the closing date and time, direct any written enquiries relating to the RFQ to the following Transnet employee:

Name: Thabang Thutubula 053 838 3278 Email: Thabang.thutubula@transnet.net

c) Respondents may also, at any time after the closing date of the RFQ, communicate with Christopher Williams on any matter relating to its RFQ response:

Telephone 053 8383477 Email Christopher.williams@transnet.net

### **4 Tax Clearance**

The Respondent's original and valid Tax Clearance Certificate must accompany the Quotation. Note that no business shall be awarded to any Respondent whose tax matters have not been declared by SARS to be in order.

### **5 VAT Registration**

The valid VAT registration number must be stated here: \_\_\_\_\_ *[if applicable]*.

### **6 Legal Compliance**

The successful Respondent shall be in full and complete compliance with any and all applicable national and local laws and regulations.

### **7 Changes to Quotations**

Changes by the Respondent to its submission will not be considered after the closing date and time.

## **8 Pricing**

All prices must be and quoted in South African Rand on a fixed price basis, excluding VAT.

## **9 Prices Subject to Confirmation**

Prices quoted which are subject to confirmation will not be considered.

## **10 Negotiations**

Transnet reserves the right to undertake post-tender negotiations with selected Respondents or any number of short-listed Respondents.

## **11 Binding Offer**

Any Quotation furnished pursuant to this Request shall be deemed to be an offer. Any exceptions to this statement must be clearly and specifically indicated.

## **12 Disclaimers**

Transnet is not committed to any course of action as a result of its issuance of this RFQ and/or its receipt of a Quotation in response to it. Please note that Transnet reserves the right to:

- modify the RFQ's goods / service(s) and request Respondents to re-bid on any changes;
- reject any Quotation which does not conform to instructions and specifications which are detailed herein;
- disqualify Quotations submitted after the stated submission deadline;
- not necessarily accept the lowest priced Quotation;
- reject all Quotations, if it so decides;
- place an order in connection with this Quotation at any time after the RFQ's closing date;
- award only a portion of the proposed goods / service/s which are reflected in the scope of this RFQ;
- split the award of the order/s between more than one Supplier/Service Provider; or
- make no award at all.

Transnet reserves the right to award business to the highest scoring bidder/s unless objective criteria justify the award to another bidder.

## **13 Transnet's supplier integrity pact**

Transnet's Integrity Pact requires a commitment from suppliers and Transnet that they will not engage in any corrupt and fraudulent practices, anti-competitive practices; and act in bad faith towards each other. The Integrity Pact also serves to communicate Transnet's Gift Policy as well as the remedies available to Transnet where a Respondent contravenes any provision of the Integrity Pact.

Respondents are required to familiarise themselves with the contents of the Integrity Pact which is available on the Transnet Internet site [[www.transnet.net/Tenders/Pages/default.aspx](http://www.transnet.net/Tenders/Pages/default.aspx)] or on request. Furthermore, Respondents are required to certify that they have acquainted themselves with all the documentation comprising the Transnet Integrity Pact and that they fully comply with all the terms and conditions stipulated in the Transnet Supplier Integrity Pact as follows:

<b>YES</b>	
------------	--

<b>NO</b>	
-----------	--

Should a Respondent need to declare previous transgressions or a serious breach of law in the preceding 5 years as required by Annexure A to the Integrity Pact, such declaration must accompany the Respondent's bid submission.

**14 Evaluation Criteria**

**Transnet will utilise the following criteria [not necessarily in this order] in choosing a Supplier/Service Provider, if so required:**

<b>Criterion/Criteria</b>	<b>Explanation</b>
<b>Administrative responsiveness</b>	Completeness of response and returnable documents
<b>Substantive responsiveness</b>	Prequalification criteria, if any, must be met and whether the Bid materially complies with the scope and/or specification given. <ul style="list-style-type: none"> <li>Indicate any technical prequalification criteria</li> </ul>
<b>Final weighted evaluation based on 80/20 preference point system as indicated in paragraph Error! Reference source not found.</b>	<ul style="list-style-type: none"> <li>Pricing and price basis [firm] - whilst not the sole factor for consideration, competitive pricing and overall level of unconditional discounts<sup>1</sup> will be critical</li> <li>B-BBEE status of company - Preference points will be awarded to a bidder for attaining the B-BBEE status level of contribution in accordance with the table indicated in Annexure A.</li> </ul>

**15 Validity Period**

Transnet desires a validity period of 30 [thirty] days from the closing date of this RFQ.

This RFQ is valid until \_\_\_\_\_.

**16 Banking Details**

<sup>1</sup> Only unconditional discounts will be taken into account during evaluation. A discount which has been offered conditionally will, despite not being taken into account for evaluation purposes, be implemented when payment is effected.

BANK: \_\_\_\_\_

BRANCH NAME / CODE: \_\_\_\_\_

ACCOUNT HOLDER: \_\_\_\_\_

ACCOUNT NUMBER: \_\_\_\_\_

**17 Company Registration**

Registration number of company / C.C. \_\_\_\_\_

Registered name of company / C.C. \_\_\_\_\_

**18 Disclosure of Prices Quoted**

Respondents must indicate here whether Transnet may disclose their quoted prices and conditions to other Respondents:

YES  NO

**19 Returnable Documents**

**Returnable Documents** means all the documents, Sections and Annexures, as listed in the tables below.

a) Respondents are required to submit with their Quotations the **Returnable Documents**, as detailed below.

***Failure to provide all these Returnable Documents at the Closing Date and time of this RFQ may result in a Respondent's disqualification. Respondents are therefore urged to ensure that all these Documents are returned with their Quotations.***

All Sections, as indicated in the footer of each page, must be signed, stamped and dated by the Respondent. Please confirm submission of these Returnable Documents by so indicating [Yes or No] in the table below:

Returnable Documents	Submitted [Yes or No]
SECTION 1 : Notice to Bidders	
- Valid and original B-BBEE Verification Certificate or certified copy thereof [Large Enterprises and QSEs] Note: failure to provide a valid B-BBEE Verification Certificate at the closing date and time of the RFQ will result in an automatic score of zero for preference	
- Valid and original B-BBEE certificate/sworn affidavit or certified copy thereof from auditor, accounting officer or SANAS accredited Verification Agency [EMEs] Note: failure to provide a valid B-BBEE Verification Certificate at the closing date and time of the RFQ will result in an automatic score of zero being allocated for preference	
- In the case of Joint Ventures, a copy of the Joint Venture Agreement or written confirmation of the intention to enter into a Joint Venture Agreement	
- Original valid Tax Clearance Certificate [Consortia / Joint Ventures must submit a separate Tax Clearance Certificate for each party]	

Returnable Documents	Submitted [Yes or No]
SECTION 2 : Quotation Form	
SECTION 3: Vendor Application Form	
• Original cancelled cheque or bank verification of banking details	
• Certified copies of IDs of shareholder/directors/members [as applicable]	
• Certified copies of the relevant company registration documents from Companies and Intellectual Property Commission (CIPC)	
• Certified copies of the company's shareholding/director's portfolio	
• Certified copy of valid Company Registration Certificate [if applicable]	
ANNEXURE A – B-BBEE Preference Points Claim Form	

b) In addition to the requirements of paragraph a) above, Respondents are further requested to submit with their Proposals the following **additional documents** as detailed below.

Please confirm submission of these additional documents by so indicating [Yes or No] in the table below:

Additional Documents	SUBMITTED [Yes or No]
Valid Letter of Good standing from the Compensation Commissioner at the Department of Labour	

"PREVIEW ONLY COPY"



**Section 2**  
**QUOTATION FORM**

I/We \_\_\_\_\_  
hereby offer to supply the goods/services at the prices quoted in the Price Schedule below, in accordance with the conditions related thereto.

I/We agree to be bound by those terms and conditions in:

- the Standard Terms and Conditions for the Supply of Goods or Services to Transnet [available on request]; and
- any other standard or special conditions mentioned and/or embodied in this Request for Quotation.

I/We accept that unless Transnet should otherwise decide and so inform me/us, this Quotation [and, if any, its covering letter and any subsequent exchange of correspondence], together with Transnet's acceptance thereof shall constitute a binding contract between Transnet and me/us.

I/We further agree that if, after I/we have been notified of the acceptance of my/our Quotation, I/we fail to deliver the said goods/service/s within the delivery lead-time quoted, Transnet may, without prejudice to any other legal remedy which it may have, cancel the order and recover from me/us any expenses incurred by Transnet in calling for Quotations afresh and/or having to accept any less favourable offer.

**Price Schedule**

I/We quote as follows for the goods required, on a "delivered nominated destination" basis, excluding VAT

1

**Delivery Lead-Time from date of purchase order :** \_\_\_\_\_ **[days/weeks]**

**Notes to Pricing:**

- a) All Prices must be quoted in South African Rand, exclusive of VAT
- b) To facilitate like-for-like comparison bidders must submit pricing strictly in accordance with this price schedule and not utilise a different format. Deviation from this pricing schedule could result in a bid being disqualified.
- c) Please note that should you have offered a discounted price(s), Transnet will only consider such price discount(s) in the final evaluation stage if offered on an unconditional basis.

<b>Supply,deliver&amp;install new signal power equipment on Postmasburg-</b>		
<b>Mamathwane section and Kamfersdam-Warrenton section and remove</b>		
<b>redundant power equipment</b>		
<b>SCHEDULE OF PRICES</b>		<b>ANNEXURE 1</b>
<b>CONTRACTOR :</b>		
1	Material	
2	Cable laying, Trenching and general Labour	
3	Pre-test and commissioning	
4	Contract Manager	
5	Transport	
6	Plant and Equipment(small)	
7	Plant and Equipment(heavy duty)	
8	Planning and design	
9	Installation	
10	Site supervision	
11	Site Establishment and security	
12	Expenses	
13	Quality control ISO 9001	
14	Preliminary and General	
15	Accomodation	
16	Sundries	
17	Remove of redundat material	
18		
19		
20		
	<b>SUB-TOTAL</b>	R -
	<b>VAT @ 14%</b>	
	<b>TOTAL ESTIMATED COST</b>	R -

\_\_\_\_\_  
 CONTRACT MANAGER

DATE :

**Section 3**  
**VENDOR APPLICATION FORM**

*Respondents are to furnish the following documentation and complete the Vendor Application Form below:*

1. **Original** cancelled cheque **OR** letter from the Respondent's bank verifying banking details **[with bank stamp]**
2. **Certified** copy of Identity Document(s) of Shareholders/Directors/Members [where applicable]
3. **Certified copies** of the relevant company registration documents from Companies and Intellectual Property Commission (CIPC)
4. **Certified copies** of the company's shareholding/director's portfolio
5. A letter on the company's letterhead confirm physical and postal addresses
6. **Original** valid SARS Tax Clearance Certificate
7. **Certified copy** of VAT Registration Certificate
8. **A valid and original** B-BBEE Verification Certificate / sworn affidavit **or certified copy** thereof meeting the requirements for B-BBEE compliance as per the B-BBEE Codes of Good Practice
9. **Certified copy** of valid Company Registration Certificate [if applicable]

"PREVIEW ONLY COPY"

# Supplier Declaration Form

Company Trading Name							
Company Registered Name							
Company Registration Number Or ID Number If A Sole Proprietor							
Form of entity	CC	Trust	Pty Ltd	Limited	Partnership	Sole Proprietor	
VAT number (if registered)							
Company Telephone Number							
Company Fax Number							
Company E-Mail Address							
Company Website Address							
Bank Name				Bank Account Number			
Postal Address						Code	
Physical Address						Code	
Contact Person							
Designation							
Telephone							
Email							
Annual Turnover Range (Last Financial Year)		< R5 Million	R5-35 million		> R35 million		
Does Your Company Provide		Products	Services		Both		
Area Of Delivery		National	Provincial		Local		
Is Your Company A Public Or Private Entity		Public			Private		
Does Your Company Have A Tax Directive Or IRP30 Certificate		Yes			No		
Main Product Or Service Supplied (E.G.: Stationery/Consulting)							
<b>BEE Ownership Details</b>							
% Black Ownership		% Black women ownership		% Disabled person/s ownership			
Does your company have a BEE certificate		Yes		No			
What is your broad based BEE status (Level 1 to 9 / Unknown)							
How many personnel does the firm employ		Permanent		Part time			
Transnet Contact Person							
Contact number							
Transnet operating division							
<b>Duly Authorised To Sign For And On Behalf Of Firm / Organisation</b>							
Name				Designation			
Signature				Date			
<b>Stamp And Signature Of Commissioner Of Oath</b>							
Name				Date			
Signature				Telephone No.			

## ANNEXURE A : B-BBEE PREFERENCE POINTS CLAIM FORM

This preference form contains general information and serves as a claim for preference points for Broad-Based Black Economic Empowerment [**B-BBEE**] Status Level of Contribution.

---

### 1. INTRODUCTION

- 1.1 A total of 10 preference points shall be awarded for B-BBEE Status Level of Contribution.
- 1.2 Failure on the part of a Bidder to fill in and/or to sign this form and submit a B-BBEE Verification Certificate from a Verification Agency accredited by the South African Accreditation System [**SANAS**] or a Registered Auditor approved by the Independent Regulatory Board of Auditors [**IRBA**] or an Accounting Officer as contemplated in the Close Corporation Act [**CCA**] together with the bid will be interpreted to mean that preference points for B-BBEE Status Level of Contribution are not claimed.
- 1.3 Transnet reserves the right to require of a Bidder, either before a Bid is adjudicated or at any time subsequently, to substantiate any claim in regard to preferences, in any manner required by Transnet.

### 2. GENERAL DEFINITIONS

- 2.1 "**all applicable taxes**" include value-added tax, pay as you earn, income tax, unemployment insurance fund contributions and skills development levies;
- 2.2 "**B-BBEE**" means broad-based black economic empowerment as defined in section 1 of the Broad-Based Black Economic Empowerment Act;
- 2.3 "**B-BBEE status of contributor**" means the B-BBEE status received by a measured entity based on its overall performance using the relevant scorecard contained in the Codes of Good Practice on Black Economic Empowerment, issued in terms of section 9(1) of the Broad-Based Black Economic Empowerment Act;
- 2.4 "**Bid**" means a written offer in a prescribed or stipulated form in response to an invitation by Transnet for the provision of goods, works or services;
- 2.5 "**Broad-Based Black Economic Empowerment Act**" means the Broad-Based Black Economic Empowerment Act, 2003 [Act No. 53 of 2003];
- 2.6 "**comparative price**" means the price after the factors of a non-firm price and all unconditional discounts that can be utilised have been taken into consideration;
- 2.7 "**consortium or joint venture**" means an association of persons for the purpose of combining their expertise, property, capital, efforts, skills and knowledge in an activity for the execution of a contract;
- 2.8 "**contract**" means the agreement that results from the acceptance of a bid by Transnet;
- 2.9 "**EME**" means any enterprise with an annual total revenue of R5 [five] million or less as per the 2007 version of the B-BBEE Codes of Good Practice and means any enterprise with an annual total

revenue of R10 [ten] million or less as per the Revised Codes of Good Practice issued on 11 October 2013 in terms of Government Gazette No. 36928;

- 2.10 **"firm price"** means the price that is only subject to adjustments in accordance with the actual increase or decrease resulting from the change, imposition, or abolition of customs and excise duty and any other duty, levy, or tax, which, in terms of the law or regulation, is binding on the contractor and demonstrably has an influence on the price of any supplies, or the rendering costs of any service, for the execution of the contract;
- 2.11 **"functionality"** means the measurement according to predetermined norms, as set out in the bid documents, of a service or commodity that is designed to be practical and useful, working or operating, taking into account, among other factors, the quality, reliability, viability and durability of a service and the technical capacity and ability of a bidder;
- 2.12 **"non-firm prices"** means all prices other than "firm" prices;
- 2.13 **"person"** includes reference to a juristic person;
- 2.14 **"QSE"** means any enterprise with an annual total revenue between R5 [five] million and R35 [thirty five] million as per the 2007 version of the B-BBEE Codes of Good Practice and means any enterprise with an annual total revenue of between R10 [ten] million and R50 [fifty] million as per the Revised Codes of Good Practice issued on 11 October 2013 in terms of Government Gazette No. 36928
- 2.15 **"rand value"** means the total estimated value of a contract in South African currency, calculated at the time of bid invitations, and includes all applicable taxes and excise duties;
- 2.16 **"subcontract"** means the primary contractor's assigning or leasing or making out work to, or employing another person to support such primary contractor in the execution of part of a project in terms of the contract;
- 2.17 **"total revenue"** bears the same meaning assigned to this expression in the Codes of Good Practice on Black Economic Empowerment, issued in terms of section 9(1) of the Broad-Based Black Empowerment Act and promulgated in the Government Gazette on 9 February 2007;
- 2.18 **"trust"** means the arrangement through which the property of one person is made over or bequeathed to a trustee to administer such property for the benefit of another person; and
- 2.19 **"trustee"** means any person, including the founder of a trust, to whom property is bequeathed in order for such property to be administered for the benefit of another person.

### 3. ADJUDICATION USING A POINT SYSTEM

- 3.1 The Bidder obtaining the highest number of total points for the evaluation criteria as enumerated in Section 2 of the RFP will be awarded the contract, unless objective criteria justifies the award to another bidder.
- 3.2 Preference points shall be calculated after prices have been brought to a comparative basis taking into account all factors of non-firm prices and all unconditional discounts.
- 3.3 Points scored will be rounded off to 2 [two] decimal places.
- 3.4 In the event of equal points scored, the Bid will be awarded to the Bidder scoring the highest number of preference points for B-BBEE.

- 3.5 However, when functionality is part of the evaluation process and two or more Bids have scored equal points including equal preference points for B-BBEE, the successful Bid will be the one scoring the highest score for functionality.
- 3.6 Should two or more Bids be equal in all respect, the award shall be decided by the drawing of lots.

"PREVIEW ONLY COPY"

#### 4. POINTS AWARDED FOR B-BBEE STATUS LEVEL OF CONTRIBUTION

- 4.1 In terms of the Preferential Procurement Regulations, 2011, preference points shall be awarded to a Bidder for attaining the B-BBEE status level of contribution in accordance with the table below:

**[delete either column "Maximum 10" ]**

B-BBEE Status Level of Contributor	Number of Points [Maximum 10]
1	10
2	9
3	8
4	5
5	4
6	3
7	2
8	1
Non-compliant contributor	0

- 4.2 Bidders who qualify as EMEs in terms of the 2007 version of the Codes of Good Practice must submit a certificate issued by an Accounting Officer as contemplated in the CCA or a Verification Agency accredited by SANAS or a Registered Auditor. Registered auditors do not need to meet the prerequisite for IRBA's approval for the purpose of conducting verification and issuing EME's with B-BBEE Status Level Certificates.
- 4.3 Bidders who qualify as EMEs in terms of the Revised Codes of Good Practice issued on 11 October 2013 in terms of Government Gazette No. 36928 are only required to obtain a sworn affidavit on an annual basis confirming that the entity has an Annual Total Revenue of R10 million or less and the entity's Level of Black ownership.
- 4.4 In terms of the 2007 version of the Codes of Good Practice, Bidders other than EMEs must submit their original and valid B-BBEE status level verification certificate or a certified copy thereof, substantiating their B-BBEE rating issued by a Registered Auditor approved by IRBA or a Verification Agency accredited by SANAS.
- 4.5 In terms of the Revised Codes of Good Practice issued on 11 October 2013 in terms of Government Gazette No. 36928, Bidders who qualify as QSEs are only required to obtain a sworn affidavit on an annual basis confirming that the entity has an Annual Total Revenue of R50 million or less and the entity's Level of Black ownership. Large enterprises must submit their original and valid B-BBEE status level verification certificate or a certified copy thereof, substantiating their B-BBEE rating issued by a Registered Auditor approved by IRBA or a Verification Agency accredited by SANAS.
- 4.6 A trust, consortium or joint venture will qualify for points for its B-BBEE status level as a legal entity, provided that the entity submits its B-BBEE status level certificate.
- 4.7 A trust, consortium or joint venture will qualify for points for their B-BBEE status level as an unincorporated entity, provided that the entity submits their consolidated B-BBEE scorecard as if they were a group structure and that such a consolidated B-BBEE scorecard is prepared for every separate bid.



- 4.8 Tertiary institutions and public entities will be required to submit their B-BBEE status level certificates in terms of the specialised scorecard contained in the B-BBEE Codes of Good Practice.
- 4.9 A person will not be awarded points for B-BBEE status level if it is indicated in the Bid documents that such a Bidder intends subcontracting more than 25% [twenty-five per cent] of the value of the contract to any other enterprise that does not qualify for at least the same number of points that such a Bidder qualifies for, unless the intended subcontractor is an EME that has the capability and ability to execute the subcontract.
- 4.10 A person awarded a contract may not subcontract more than 25% [twenty-five per cent] of the value of the contract to any other enterprise that does not have an equal or higher B-BBEE status level than the person concerned, unless the contract is subcontracted to an EME that has the capability and ability to execute the subcontract.
- 4.11 Bidders are to note that in terms of paragraph 2.6 of Statement 000 of the Revised Codes of Good Practice issued on 11 October 2013 in terms of Government Gazette No. 36928, any representation made by an entity about its B-BBEE compliance must be supported by suitable evidence or documentation. As such, Transnet reserves the right to request such evidence or documentation from Bidders in order to verify any B-BBEE recognition claimed.

## 5. B-BBEE STATUS AND SUBCONTRACTING

### 5.1 Bidders who claim points in respect of B-BBEE Status Level of Contribution must complete the following:

B-BBEE Status Level of Contributor \_\_\_\_\_ = \_\_\_\_\_ [maximum of 20 points]

Note: Points claimed in respect of this paragraph 5.1 must be in accordance with the table reflected in paragraph 4.1 above and must be substantiated by means of a B-BBEE certificate issued by a Verification Agency accredited by SANAS or a Registered Auditor approved by IRBA or a sworn affidavit in the case of an EME or QSE.

### 5.2 Subcontracting:

Will any portion of the contract be subcontracted? YES/NO [delete which is not applicable]

If YES, indicate:

- (i) What percentage of the contract will be subcontracted? .....
- (ii) The name of the subcontractor .....
- (iii) The B-BBEE status level of the subcontractor .....
- (iv) Is the subcontractor an EME? YES/NO

5.3 Declaration with regard to Company/Firm

- (i) Name of Company/Firm.....
- (ii) VAT registration number.....
- (iii) Company registration number.....
- (iv) Type of Company / Firm [TICK APPLICABLE BOX]

- Partnership/Joint Venture/Consortium
- One person business/sole propriety
- Close Corporations
- Company (Pty) Ltd

- (v) Describe Principal Business Activities

.....  
.....  
.....

- (vi) Company Classification [TICK APPLICABLE BOX]

- Manufacturer
- Supplier
- Professional Service Provider
- Other Service Providers, e.g Transporter, etc

- (vii) Total number of years the company/firm has been in business.....

"PREVIEW ONLY COPY"

**BID DECLARATION**

I/we, the undersigned, who warrants that he/she is duly authorised to do so on behalf of the company/firm, certify that points claimed, based on the B-BBEE status level of contribution indicated in paragraph 4 above, qualifies the company/firm for the preference(s) shown and I / we acknowledge that:

- (i) The information furnished is true and correct.
- (ii) In the event of a contract being awarded as a result of points claimed as shown in paragraph 6 above, the contractor may be required to furnish documentary proof to the satisfaction of Transnet that the claims are correct.
- (iii) If the B-BBEE status level of contribution has been claimed or obtained on a fraudulent basis or any of the conditions of contract have not been fulfilled, Transnet may, in addition to any other remedy it may have:
  - (a) disqualify the person from the bidding process;
  - (b) recover costs, losses or damages it has incurred or suffered as a result of that person's conduct;
  - (c) cancel the contract and claim any damages which it has suffered as a result of having to make less favourable arrangements due to such cancellation;
  - (d) restrict the Bidder or contractor, its shareholders and directors, and/or associated entities, or only the shareholders and directors who acted in a fraudulent manner, from obtaining business from Transnet for a period not exceeding 10 years, after the *audi alteram partem* [hear the other side] rule has been applied; and/or
  - (e) forward the matter for criminal prosecution.

**WITNESSES:**

- 1. ....
- 2. ....

SIGNATURE OF BIDDER

DATE:.....

COMPANY NAME: .....

ADDRESS:.....

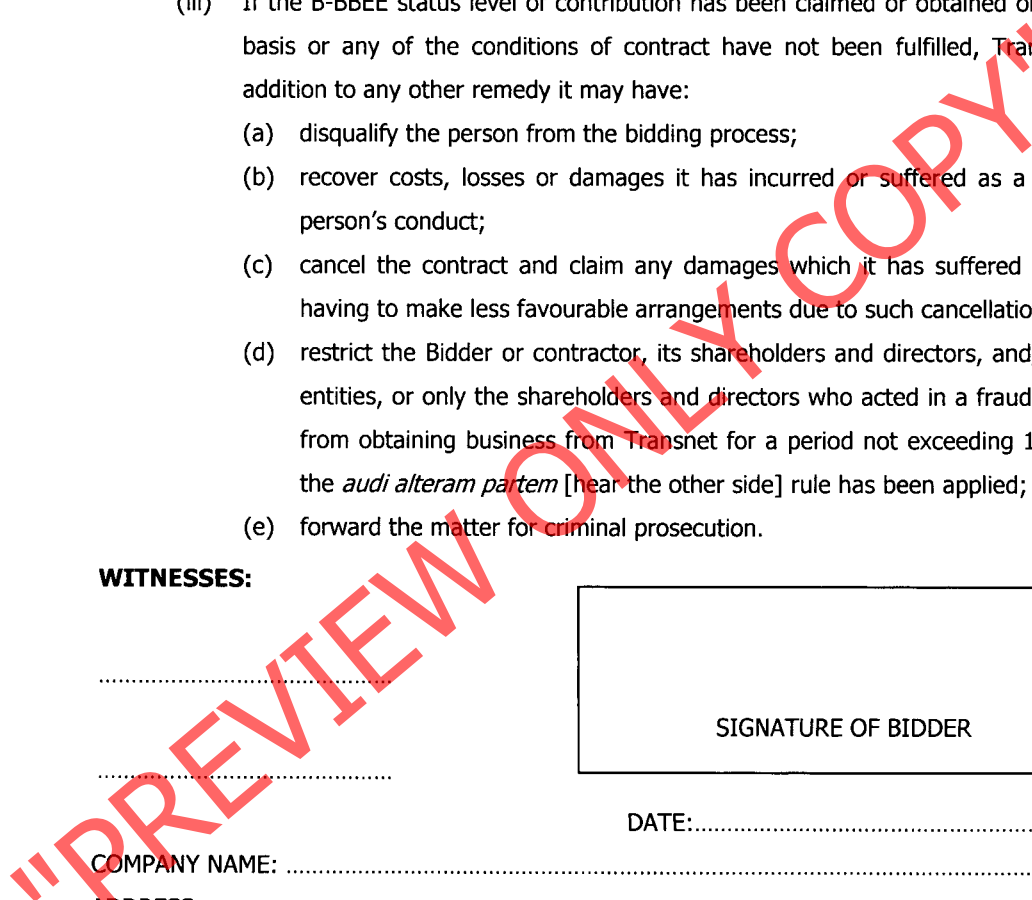



**TRANSNET**  
*freight rail*

A Division of Transnet Limited

**RAIL NETWORK  
TECHNICAL  
TRAIN AUTHORISATION SYSTEMS**

**PROJECT SPECIFICATION**

---

**KIMBERLEY NORTH DEPOT (SIGNALS)  
SUPPLY, DELIVER AND INSTALL NEW POWER EQUIPMENT  
– REMOVE OBSOLETE POWER EQUIPMENT**

---

Date

April 2014

**"PREVIEW ONLY COPY"**

## 1. SCOPE

The scope of work required by Kimberley North depot is for the supply, delivery and installation of new power equipment and removal of existing obsolete power equipment at 9 sites between Postmasburg and Hotazel and 3 sites between Kamfersdam and Warrenton.

## 2. SPECIFICATIONS, DRAWINGS AND STANDARDS

The Transnet Freight Rail Project Supervisor or his appointed deputy will oversee all the work to ensure compliance to specifications and standards. Planning and design will be done by Transnet Freight Rail.

## 3. APPLICABLE DOCUMENTATION

BBG1027 – Valve regulated lead acid batteries for use in signal installations.

BBG1023, BBG1499, BBG1500, BBG1501, BBG1502 – Battery stands drawings.

Relay room power plans.

Schematic map.

## 4. INSTALLATION AND LABOUR REQUIREMENTS

4.1 The Contractor shall have previous experience with the installation of power equipment in signal relay rooms. A list of projects where the tenderer have been contracted to do similar work must be submitted.

4.2 All personnel shall have the required safety clothing for the type of work to be done.

4.3 The contractor and his personnel shall attend an induction training session and be in possession of a site access certificate issued by the depot engineer before any work may start. The installation team shall have the certificates with them at all times when on site.

## 5. INSTALLATION AND REMOVAL

5.1 Installation and removal shall take place as per table below:

BEESHOEK	INSTALL UPS, BATTERIES, MODIFY POWER DISTRIBUTION, REMOVE OBSOLETE CHARGER, INVERTER AND 55 X 2V VLA BATTERIES
BOKKOPPIE	INSTALL UPS, BATTERIES, MODIFY POWER DISTRIBUTION, REMOVE OBSOLETE CHARGER, INVERTER AND 55 X 2V VLA BATTERIES
PALINGPAN	INSTALL UPS, BATTERIES, MODIFY POWER DISTRIBUTION, REMOVE OBSOLETE CHARGER, INVERTER AND 55 X 2V VLA BATTERIES
GLOSAM	INSTALL UPS, BATTERIES, MODIFY POWER DISTRIBUTION, REMOVE OBSOLETE CHARGER, INVERTER AND 55 X 2V VLA BATTERIES
LOHATLA	INSTALL UPS, BATTERIES, MODIFY POWER DISTRIBUTION, REMOVE OBSOLETE CHARGER, INVERTER AND 55 X 2V VLA BATTERIES
HAAKBOSLEEGTE	INSTALL UPS, BATTERIES, MODIFY POWER DISTRIBUTION, REMOVE OBSOLETE CHARGER, INVERTER AND 55 X 2V VLA BATTERIES
GAMAGARA	INSTALL UPS, BATTERIES, MODIFY POWER DISTRIBUTION, REMOVE OBSOLETE CHARGER, INVERTER AND 55 X 2V VLA BATTERIES
EMIL	INSTALL UPS, BATTERIES, MODIFY POWER DISTRIBUTION, REMOVE OBSOLETE CHARGER, INVERTER AND 55 X 2V VLA BATTERIES
MAMATHWANE	INSTALL UPS, MODIFY POWER DISTRIBUTION, REMOVE OBSOLETE

	CHARGER, INVERTER
MACFARLANE	INSTALL NEW VRLA AND REMOVE OBSOLETE VRLA BATTERIES
RIVERTON	INSTALL NEW VRLA AND REMOVE OBSOLETE VRLA BATTERIES
WINDSORTON	INSTALL NEW VRLA AND REMOVE OBSOLETE VRLA BATTERIES

- 5.2 Modifications must be done in the power distribution cubicle to accommodate the change from charger/inverter to UPS technology.
- 5.3 All obsolete power equipment (chargers, inverters and VLA batteries) shall be removed and transported to Supply Chain Services stores at Kimberley.
- 5.4 The work must start within 18 weeks from date of order and completed within 3 weeks from start date.
- 5.5 Each site shall be completed in one day.
- 5.6 Hours of work will be from 07:30 to 16:00 Monday to Friday.
- 5.7 Occupation time shall be between 10:00 to 15:00 daily. The TFR representative shall be responsible to arrange the occupations.

**6. MATERIAL TO BE SUPPLIED BY CONTRACTOR**

DESCRIPTION	QTY	PRICE EACH	PRICE TOTAL
NSB170FT 12V VRLA "RED" BATTERY (SET OF 22) WITH LINKS TRANSNET APPROVED	11		
STEEL STANDS (SET OF 3) WITH ADJUSTABLE FEET. TRANSNET APPROVED	11		
MP200 10KVA UPS 230/230 TRANSNET APPROVED	9		
CABLE PERMOTRAIL ORANGE 16mm 4 CORE 100m ROLL (SABS1507)	1		
CABTYRE 0,75mm BLACK 7 CORE 100m ROLL (SABS1574)	1		
PERMOPOWER CABLE 16mm RED 100m ROLL (SABS1507)	1		
PERMOPOWER CABLE 16mm BLACK 100m ROLL (SABS1507)	1		
TRUNKING SOLID GREY 50mm x 50mm x 3m LENGTH	30		
ISOLATION TRANSFORMER 3KVA PRI. 0-220-230 SEC. 0-120-130 WITH TRANSPARENT COVER	10		
SEMIKRON SEMIPACK SKKT 75/1600	20		
HEATSINK TO MOUNT SEMIPACK (FULL BRIDGE RECTIFIER)	9		
ALLOWANCE FOR LUGS AND ACCESSORIES	1		
LABOUR	1		
TRANSPORT	1		
ACCOMMODATION	1		
<b>TOTAL</b>			

7.0 **SAFETY REQUIREMENTS**

The contractor shall submit a safety file covering the following:

7.1 Appointment letters

Crane operator  
Risk assessor  
Supervisor  
First aider

7.2 Certification and training

Crane operator  
Basic rigging  
First aid  
Medical fitness certificates  
Spill procedures

8. **COMPLIANCE TO SPECIFICATION**

The tenderer shall submit a clause by clause statement of compliance to this specification.

**END OF SPECIFICATION**

"PREVIEW ONLY COPY"

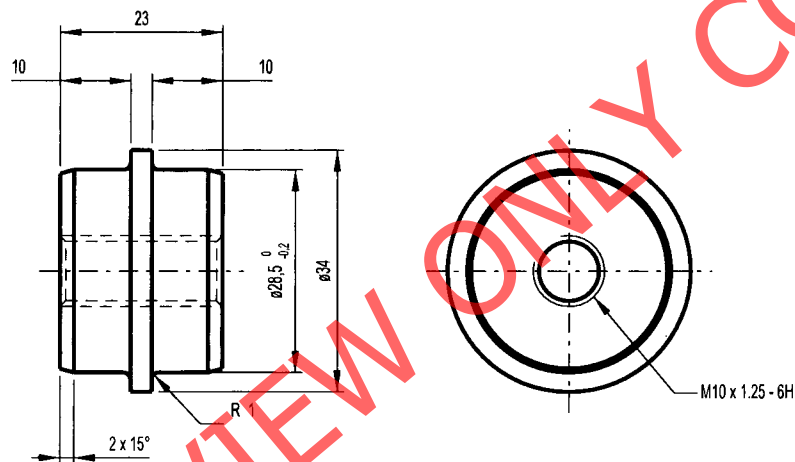

"PREVIEW ONLY COPY"

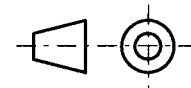

© COPYRIGHT PROTECTED. PREPARED BY CENTRAL DRAWING OFFICE

DIMENSIONS : mm SCALE : 1 : 1  
 TOLERANCE : LIN ± 0.5 ANG ± 2° ITEM NO : -  
 MATERIAL : ROUND BAR, STEEL ø34 x 23 LONG  
 VERSION INFO : -

+

APPROVED

+

AUTHORISED

FOOT BUSH FOR STEEL BATTERY  
 STAND IN RELAY ROOMS  
 (8 x FRONT AND TOP TERMINAL)

**TRANSNET**  
*freight rail*

---

**BBG1500**  
 VERSION 1

A4

DO REF: CDD/8023

ECP REF: -

DRAWN: CJ Marais

DESIGNED: -

CHECKED: H v Vuuren



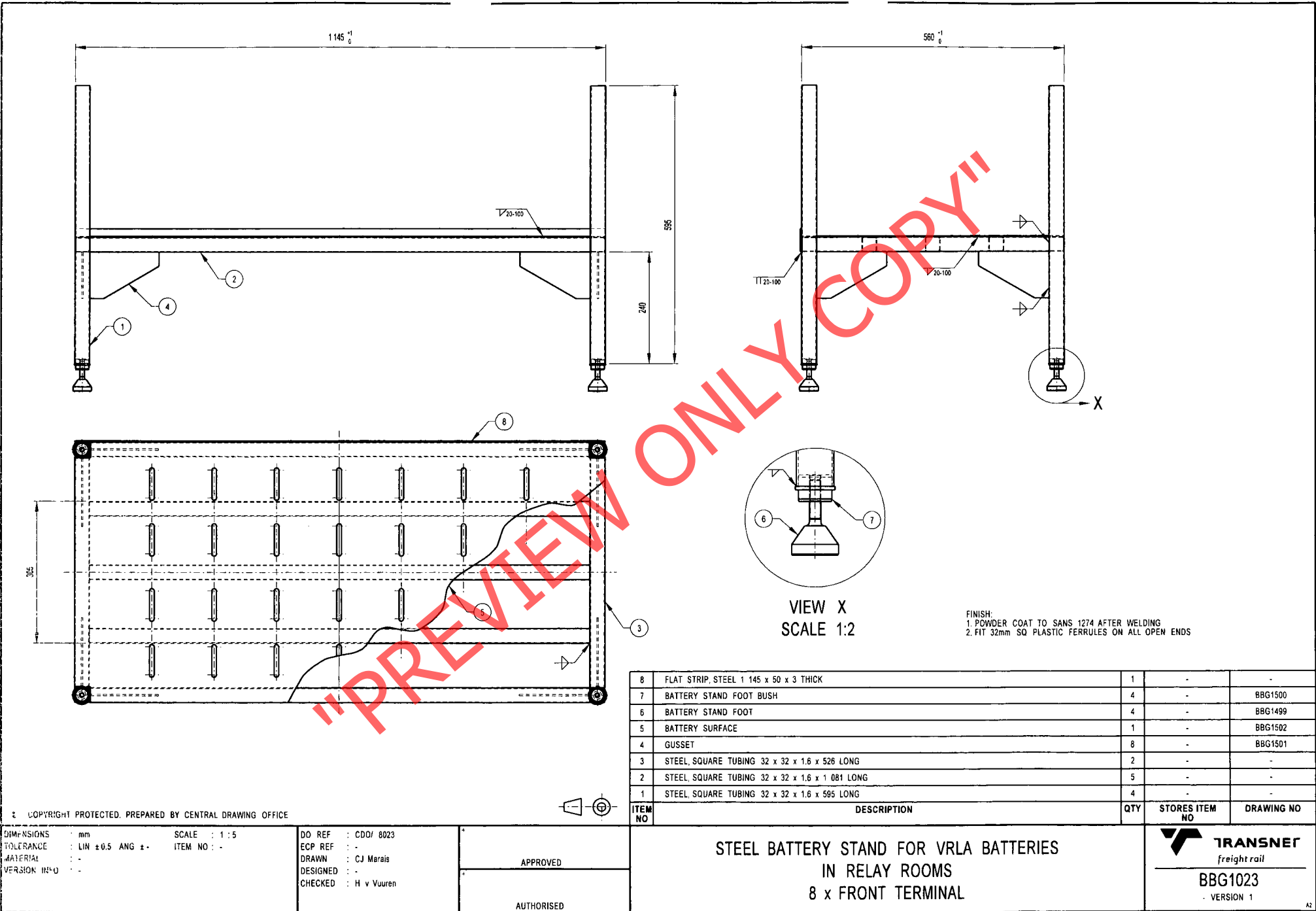

FINISH:  
 1. POWDER COAT TO SANS 1274 AFTER WELDING  
 2. FIT 32mm SQ PLASTIC FERRULES ON ALL OPEN ENDS

8	FLAT STRIP, STEEL 1 145 x 50 x 3 THICK	1	-	-
7	BATTERY STAND FOOT BUSH	4	-	BBG1500
6	BATTERY STAND FOOT	4	-	BBG1499
5	BATTERY SURFACE	1	-	BBG1502
4	GUSSET	8	-	BBG15D1
3	STEEL, SQUARE TUBING 32 x 32 x 1.6 x 526 LONG	2	-	-
2	STEEL, SQUARE TUBING 32 x 32 x 1.6 x 1 081 LONG	5	-	-
1	STEEL, SQUARE TUBING 32 x 32 x 1.6 x 595 LONG	4	-	-
ITEM NO	DESCRIPTION	QTY	STORES ITEM NO	DRAWING NO

© COPYRIGHT PROTECTED. PREPARED BY CENTRAL DRAWING OFFICE

DIMENSIONS : mm  
 TOLERANCE : LIN ±0.5 ANG ±°  
 MATERIAL : -  
 VERSION IN°0 : -

SCALE : 1 : 5  
 ITEM NO : -

DO REF : CDD/ 8023  
 ECP REF : -  
 DRAWN : CJ Marais  
 DESIGNED : -  
 CHECKED : H v Vuuren

APPROVED  
 AUTHORIZED

**STEEL BATTERY STAND FOR VRLA BATTERIES  
 IN RELAY ROOMS  
 8 x FRONT TERMINAL**

**TRANSNER**  
 freight rail  
**BBG1023**  
 VERSION 1



**TRANSNET**  
*freight rail*

A Division of Transnet SOC Limited

## TECHNOLOGY MANAGEMENT

### SPECIFICATION

# VALVE REGULATED LEAD ACID BATTERIES FOR USE IN SIGNAL INSTALLATIONS

Author: Chief Engineering Technician  
Rail Network P Doorewaard

Approved: Senior Engineer  
Technology Management RA Langley

Authorised: Principal Engineer  
Technology Management J kannemeyer

Date: September 2013

Circulation Restricted To:

Transnet and Relevant Third Parties

© This document as a whole is protected by copyright. The information herein is the sole property of Transnet SOC Ltd. It may not be used, disclosed or reproduced in part or in whole in any manner whatsoever, except with the written permission of and in a manner permitted by the proprietors.

---

## 1. **SCOPE**

### 1.1 **Identification.**

12V Valve regulated lead acid (AGM) front terminal 10 year + design life batteries.

### 1.2 **Item overview.**

The valve regulated lead acid (VRLA) batteries are required to provide standby power to Signal relay rooms for a minimum of 10 hours. Size of battery shall be specified by Transnet Freight Rail.

### 1.3 **Document overview.**

The VRLA batteries within Transnet Freight Rail (Train Authorisation Systems) shall comply with the requirements as set out in this document. This document may therefore be used for item purchasing and approval.

## 2. **REQUIREMENTS**

The requirements as set out below must be complied with. It is required that a statement be issued stating compliance per clause as well as the actual guaranteed technical data of the equipment offered. Failure to submit a statement of compliance shall automatically disqualify the tenderer.

Offers which include deviations of a minor nature from the terms of this specification will be considered at the discretion of Transnet Freight Rail (Train Authorisation systems).

## 3. **BATTERY FEATURES**

3.1 The battery shall be of the Absorbent Glass Mat (AGM) type technology for efficient gas recombination and freedom from electrolyte maintenance or water adding.

3.2 The battery shall be of the front terminal type.

3.3 Minimum 10 year design life guaranteed under float conditions at a constant 25 deg. Celsius.

3.4 The battery must be suitable for long discharge periods, typically 10 hours and recharge of C/8.

3.5 Batteries shall have internationally recognised certification.

3.6 The battery shall have a UL 94 V0 rated flame retardant casing.

3.7 The battery manufacturer shall be registered to ISO9001 and ISO14001.

3.8 The battery must be compliant with SANS 60896.

## 4. **DOCUMENTATION**

4.1 Complete documentation including detailed Material safety data sheet shall be submitted

4.2 Documents to record regular test measurements shall be provided.

## 5. **PRE DELIVERY PREPARATION**

5.1 Batteries shall undergo a refresher charge upon arrival at the premises of the distributor. Thereafter the batteries shall be discharged to 1.8vpc over a period of 2 - 3 hours to eliminate any potential bad battery. Regular voltage measurements per block shall be taken when discharging.

5.2 Batteries shall be recharged at 10% of AH rating at voltage 2.4vpc. The batteries shall be connected in parallel (Battery string of 32 blocks may be split into 2 x 16 blocks) to ensure proper equalisation.

5.3 Pallets shall be marked to ensure that battery strings as charged are not mixed.

5.4 Transnet Freight Rail reserves the right to witness the preparation process.

## 6. **Warranty**

6.1 Transnet Freight Rail requires a 3 year warranty period against faulty workmanship.

**END OF SPECIFICATION**

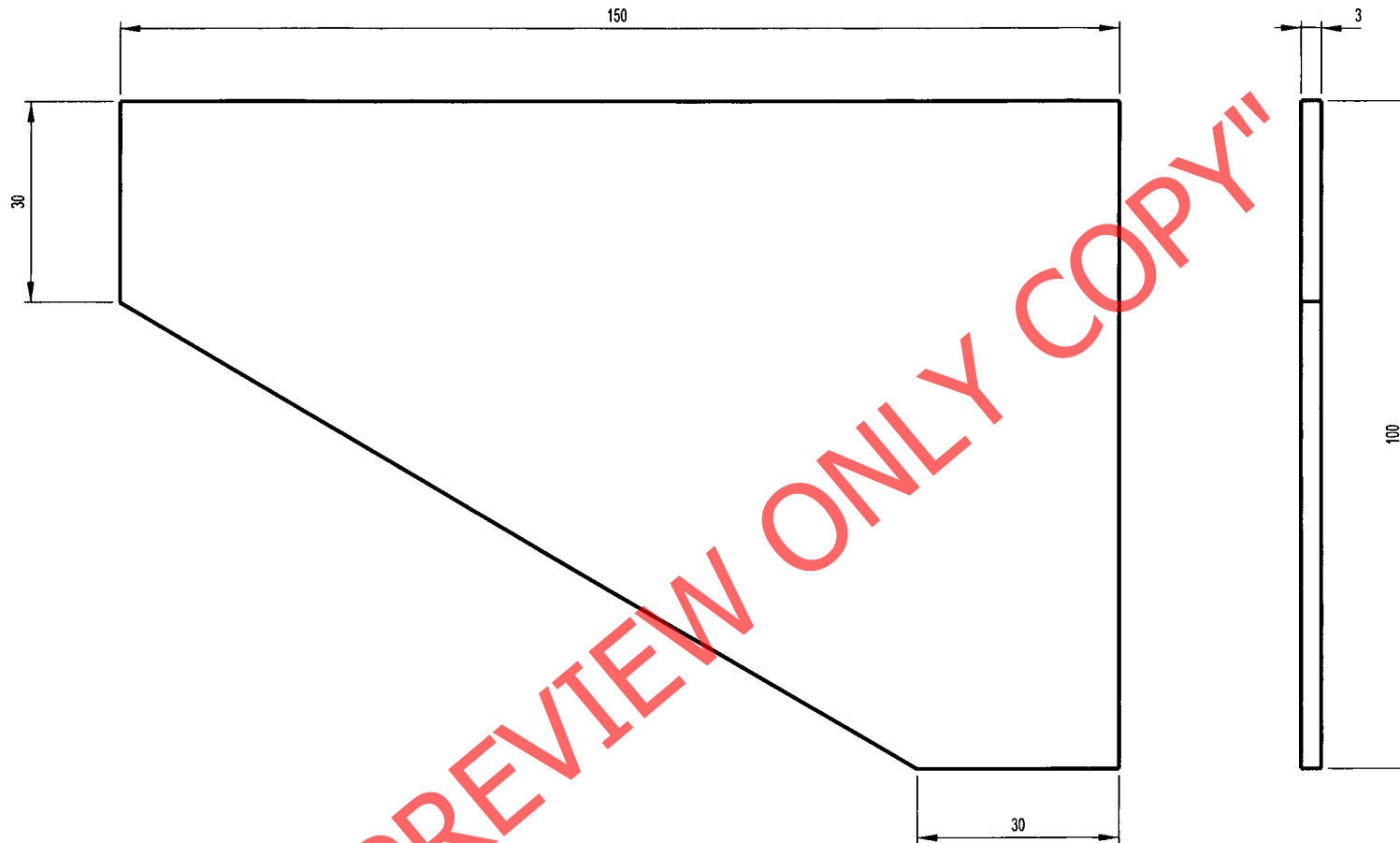

"PREVIEW ONLY COPY"

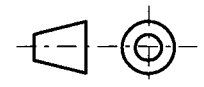

© COPYRIGHT PROTECTED. PREPARED BY CENTRAL DRAWING OFFICE

DIMENSIONS : mm SCALE : 1 : 1  
 TOLERANCE : LIN±1 ANG± - ITEM NO: -  
 MATERIAL : STEEL SHEET 150 x 100 x 3 THICK  
 VERSION INFO :-

+

APPROVED

+

AUTHORISED

**GUSSET FOR STEEL BATTERY  
 STAND IN RELAY ROOMS  
 (8 x FRONT TERMINAL)**

  
**TRANSNET**  
*freight rail*  

---

**BBG1501**  
 VERSION 1

A4

DO REF: CDO/8023

ECP REF: -

DRAWN: CJ Marais

DESIGNED: -

CHECKED: H v Vuuren

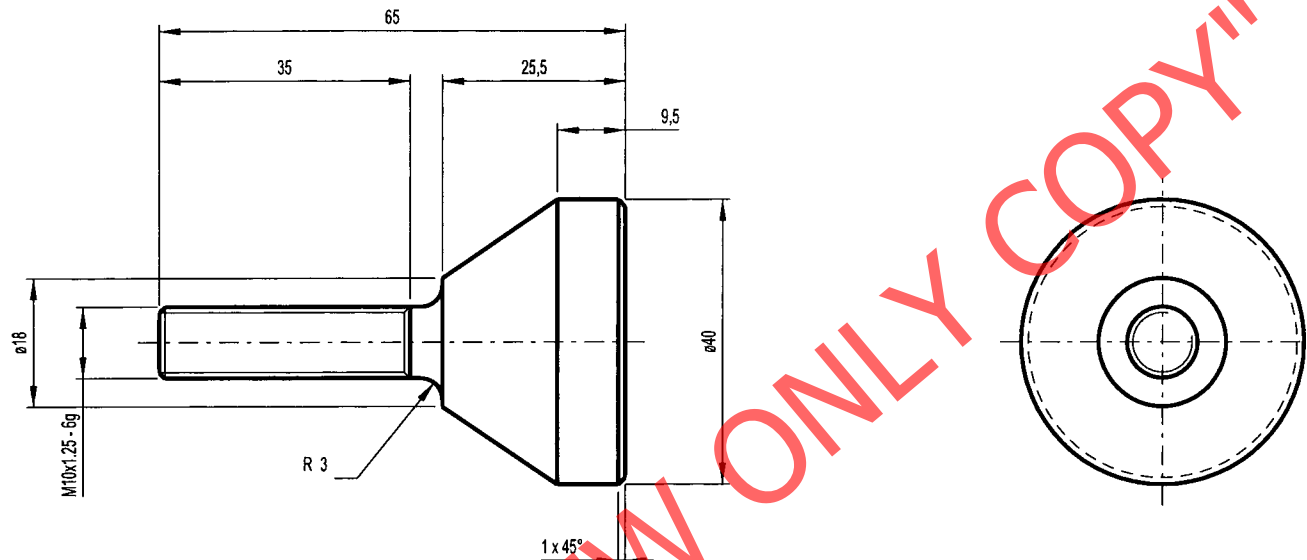

"PREVIEW ONLY COPY"

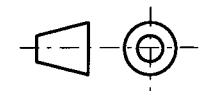

© COPYRIGHT PROTECTED. PREPARED BY CENTRAL DRAWING OFFICE

DIMENSIONS : mm SCALE : 1 : 1  
 TOLERANCE : LIN ± 0.5 ANG ± 2° ITEM NO: -  
 MATERIAL : ROUND BAR, STEEL ø40 x 65 LONG  
 VERSION INFO : -

+

APPROVED

+

AUTHORISED

FOOT FOR STEEL BATTERY  
 STAND IN RELAY ROOMS  
 (8 x FRONT AND TOP TERMINAL)

**TRANSNET**  
*freight rail*

---

**BBG1499**  
 VERSION 1

A4

DO REF: CDO/ 8023

ECP REF: -

DRAWN: CJ Marais

DESIGNED: -

CHECKED: H v Vuuren

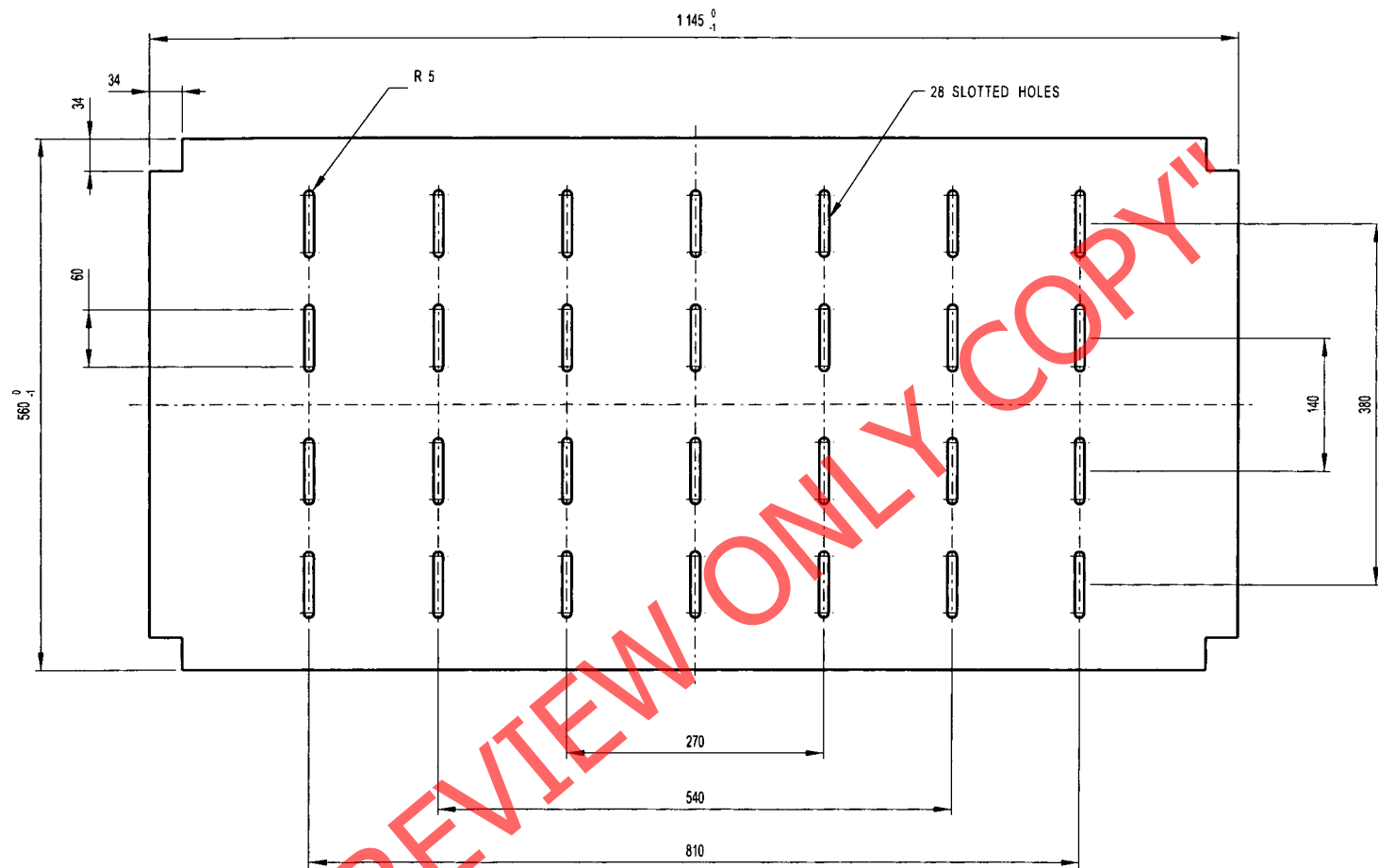

© COPYRIGHT PROTECTED. PREPARED BY CENTRAL DRAWING OFFICE

DIMENSIONS : mm SCALE : 1 : 5  
 TOLERANCE : LIN ± 0.5 ANG ± - ITEM NO : -  
 MATERIAL : STEEL SHEET 1 145 x 560 x 1.6 THICK  
 VERSION INFO : -

APPROVED

AUTHORISED

BATTERY SURFACE FOR STEEL BATTERY STAND  
 IN RELAY ROOMS  
 (8 x FRONT TERMINAL)

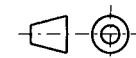

BBG1502  
 VERSION 1

A3

# EN STROME

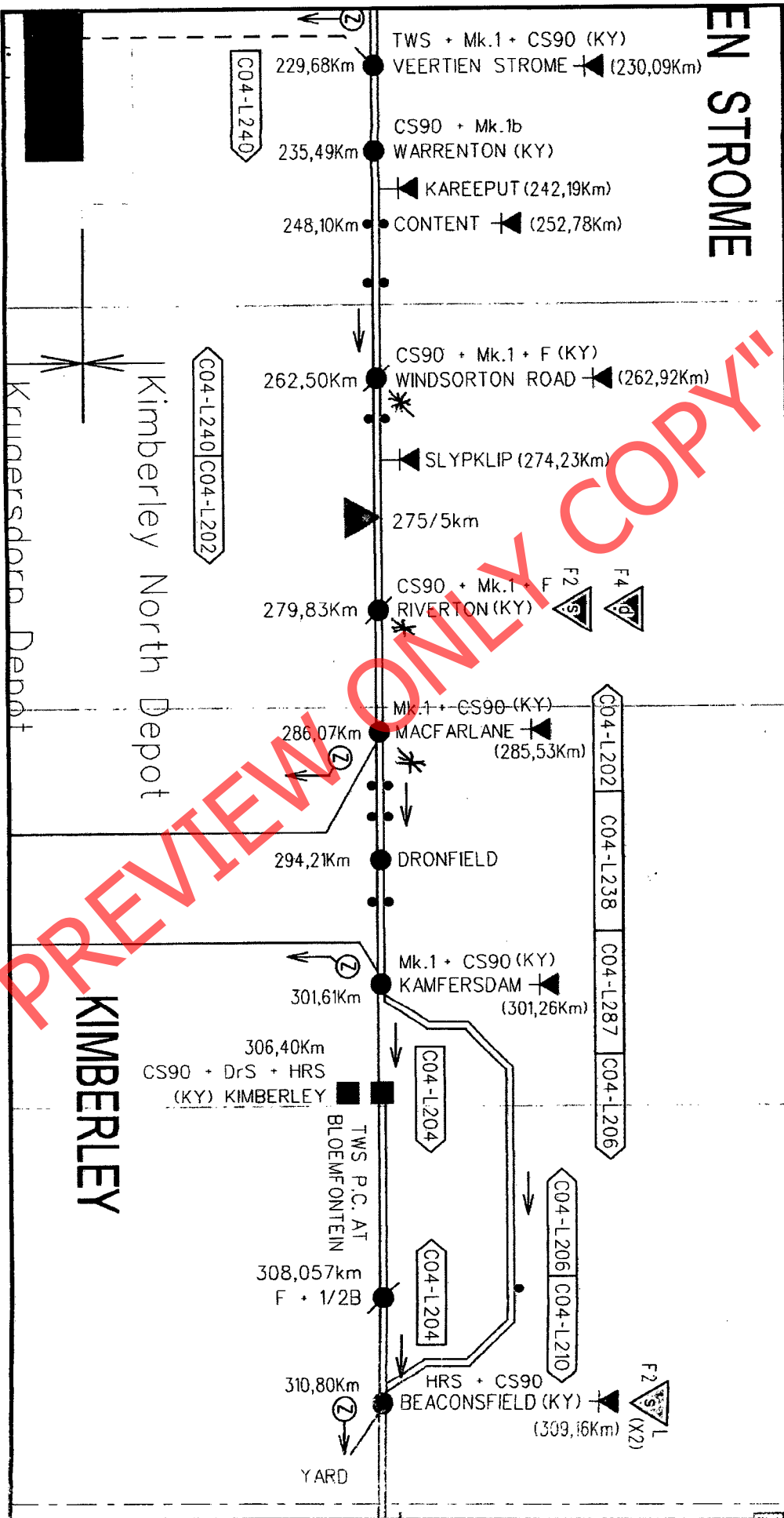

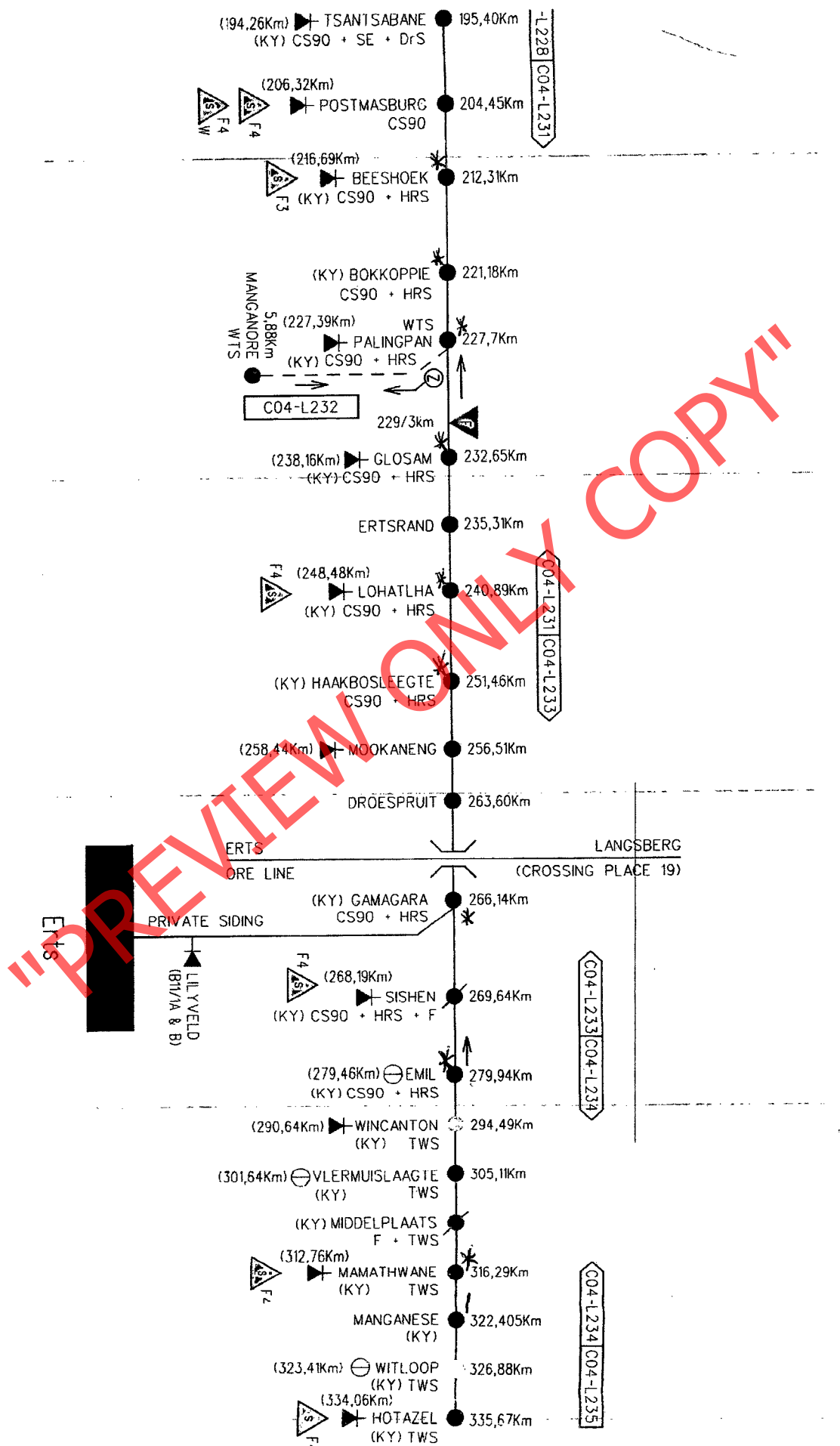



**TRANSNET SOC LIMITED**

(Registration no. 1990/000900//30)

**SAFETY ARRANGEMENTS AND PROCEDURAL COMPLIANCE  
WITH THE OCCUPATIONAL HEALTH AND SAFETY ACT  
(ACT 85 OF 1993) AND APPLICABLE REGULATIONS****1. General**

- 1.1 The Contractor and Transnet Limited (hereinafter referred to as "Transnet") are individual employers, each in its own right, with their respective duties and obligations set out in the Occupational Health and Safety Act, Act 85 of 1993 (the Act) and applicable Regulations.
- 1.2 The Contractor accepts, in terms of the General Conditions of Contract and in terms of the Act, his obligations as an employer in respect of all persons in his employ, other persons on the premises or the Site or place of work or on the work to be executed by him, and under his control. He shall, before commencement with the execution of the contract work, comply with the provisions set out in the Act, and shall implement and maintain a Health and Safety Plan as described in the Construction Regulations, 2003 and as approved by Transnet, on the Site and place of work for the duration of the Contract.
- 1.3 The Contractor accepts his obligation to complying fully with the Act and applicable Regulations notwithstanding the omission of some of the provisions of the Act and the Regulations from this document.
- 1.4 Transnet accepts, in terms of the Act, its obligations as an employer of its own employees working on or associated with the site or place of work, and the Contractor and Technical Officer or his deputy shall at all times, co-operate in respect of the health and safety management of the site, and shall agree on the practical arrangements and procedures to be implemented and maintained during execution of the Works.
- 1.5 In the event of any discrepancies between any legislation and this specification, the applicable legislation will take precedence.

**2. Definitions**

- 2.1 In this Specification any word or expression to which a meaning has been assigned in the Construction Regulations, shall have the meaning so assigned to it, unless the context otherwise indicates: -
- 2.2 The work included in this Contract shall for the purposes of compliance with the Act be deemed to be "**Construction Work**", which, in terms of the Construction Regulations, 2003 means any work in connection with: -
  - (a) the erection, maintenance, alteration, renovation, repair, demolition or dismantling of or addition to a building or any similar structure;

- (b) the installation, erection, dismantling or maintenance of fixed plant where such work includes the risk of a person falling;
  - (c) the construction, maintenance, demolition or dismantling of any bridge, dam, canal, road, railway, runway, sewer or water reticulation system or any similar civil engineering structure; or
  - (d) the moving of earth, clearing of land, the making of an excavation, piling, or any similar type of work;
- 2.3 **“competent person”** in relation to construction work, means any person having the knowledge, training and experience specific to the work or task being performed: Provided that where appropriate qualifications and training are registered as per the South African Qualifications Authority Act, 1995 these qualifications and training shall be deemed to be the required qualifications and training;
- 2.4 **“contractor”** means principal contractor and **“subcontractor”** means contractor as defined by the Construction Regulations, 2003.
- 2.5 **“fall protection plan”** means a documented plan, of all risks relating to working from an elevated position, considering the nature of work undertaken, and setting out the procedures and methods applied to eliminate the risk;
- 2.6 **“health and safety file”** means a file, or other record in permanent form, containing the information required to be kept on site in accordance with the Act and applicable Regulations;
- 2.7 **“Health and Safety Plan”** means a documented plan which addresses the hazards identified and include safe work procedures to mitigate, reduce or control the hazards identified;
- 2.8 **“Risk Assessment”** means a programme to determine any risk associated with any hazard at a construction site, in order to identify the steps needed to be taken to remove, reduce or control such hazard;
- 2.9 **“the Act”** means the Occupational Health and Safety Act No. 85 of 1993.

### 3. Procedural Compliance

- 3.1 The Contractor who intends to carry out any construction work shall, before carrying out such work, notify the Provincial Director in writing if the construction work:-
- (a) includes the demolition of a structure exceeding a height of 3 metres; or
  - (b) includes the use of explosives to perform construction work; or
  - (c) includes the dismantling of fixed plant at a height greater than 3m,
- and shall also notify the Provincial Director in writing when the construction work exceeds 30 days or will involve more than 300 person days of construction work and if the construction work:-
- (a) includes excavation work deeper than 1m; or

- (b) includes working at a height greater than 3 metres above ground or a landing.
- 3.2 The notification to the Provincial Director shall be on a form similar to Annexure A of the Construction Regulations, 2003, also shown in Annexure 1 of this Specification. The Contractor shall ensure that a copy of the completed notification form is kept on site for inspection by an inspector, Technical Officer or employee.
- 3.3 The Contractor shall, in accordance with the Act and applicable Regulations, make all the necessary appointments of competent persons in writing on a form similar to Annexure 2 of this Specification and deliver copies thereof to the Technical Officer. Copies should also be retained on the health and safety file.
- 3.4 Subcontractors shall also make the above written appointments and the Contractor shall deliver copies thereof to the Technical Officer.
- 3.5 In the case of a self-employed Contractor or any subcontractor who has the appropriate competencies and supervises the work himself, the appointment of a construction supervisor in terms of regulation 6.1 of the Construction Regulations, 2003 will not be necessary. The Contractor shall in such a case execute and sign a declaration, as in Annexure 3, by which he personally undertakes the duties and obligations of the "Chief Executive Officer" in terms of section 16(1) of the Act.
- 3.6 The Contractor shall, before commencing any work, obtain from the Technical Officer an access certificate as in Annexure 4 executed and signed by him, permitting and limiting access to the designated site or place of work by the Contractor and any subcontractors under his control.
- 3.7 Procedural compliance with Act and Regulations, as above, shall also apply to any subcontractors as employers in their own right. The Contractor shall furnish the Technical Officer with full particulars of such subcontractors and shall ensure that they comply with the Act and Regulations and Transnet's safety requirements and procedures.

#### 4. **Special Permits**

Where special permits are required before work may be carried out such as for hotwork, isolation permits, work permits and occupations, the Contractor shall apply to the Technical Officer or the relevant authority for such permits to be issued. The Contractor shall strictly comply with the conditions and requirements pertaining to the issue of such permits.

#### 5. **Health and Safety Programme**

- 5.1 The Tenderer shall, with his tender, submit a Health and Safety Programme setting out the practical arrangements and procedures to be implemented by him to ensure compliance by him with the Act and Regulations and particularly in respect of: -
- (i) The provision, as far as is reasonably practical, of a working environment that is safe and without risk to the health of his employees and subcontractors in terms of section 8 of the Act;

- (ii) the execution of the contract work in such a manner as to ensure in terms of section 9 of the Act that persons other than those in the Contractor's employment, who may be directly affected by the contract work are not thereby exposed to hazards to their health and safety;
  - (iii) ensuring, as far as is reasonably practical, in terms of section 37 of the Act that no employee or subcontractor of the Contractor does or omits to do any act which would be an offence for the Contractor to do or omit to do.
- 5.2 The Contractor's Health and Safety Programme shall be based on a risk assessment in respect of the hazards to health and safety of his employees and other persons under his control that are associated with or directly affected by the Contractor's activities in performing the contract work and shall establish precautionary measures as are reasonable and practical in protecting the safety and health of such employees and persons.
- 5.3 The Contractor shall cause a risk assessment contemplated in clause 5.2 above to be performed by a competent person, appointed in writing, before commencement of any Construction Work and reviewed during construction. The Risk Assessments shall form part of the Health and Safety programme to be applied on the site and shall include at least the following:
- (a) The identification of the risks and hazards that persons may be exposed to;
  - (b) the analysis and evaluation of the hazards identified;
  - (c) a documented Health and Safety Plan, including safe work procedures to mitigate, reduce or control the risks identified;
  - (d) a monitoring and review plan.
- 5.4 The Health and Safety Plan shall include full particulars in respect of: -
- (a) The safety management structure to be instituted on site or place of work and the names of the Contractor's health and safety representatives and members of safety committees where applicable;
  - (b) the safe working methods and procedures to be implemented to ensure the work is performed in compliance with the Act and Regulations;
  - (c) the safety equipment, devices and clothing to be made available by the Contractor to his employees;
  - (d) the site access control measures pertaining to health and safety to be implemented;
  - (e) the arrangements in respect of communication of health and safety related matters and incidents between the Contractor, his employees, subcontractors and the Technical Officer with particular reference to the reporting of incidents in compliance with Section 24 and General Administrative Regulation 8 of the Act and with the pertinent clause of the General Conditions of Contract forming part of the Contract and

- (f) the introduction of control measures for ensuring that the Safety Plan is maintained and monitored for the duration of the Contract.
- 5.4 The Health and Safety programme shall be subject to the Technical Officer's approval and he may, in consultation with the Contractor, order that additional and/or supplementary practical arrangements and procedures be implemented and maintained by the Contractor or that different working methods or safety equipment be used or safety clothes be issued which, in the Technical Officer's opinion, are necessary to ensure full compliance by the Contractor with his obligations as an employer in terms of the Act and Regulations. The Technical Officer or his deputy shall be allowed to attend meetings of the Contractor's safety committee as an observer.
- 5.5 The Contractor shall take reasonable steps to ensure that each subcontractor's Health and Safety Plan is implemented and maintained on the construction site: Provided that the steps taken, shall include periodic audits at intervals mutually agreed to between them, but at least once every month.
- 5.6 The Contractor shall stop any subcontractor from executing any construction work, which is not in accordance with the Contractor's, and/or subcontractor's Health and Safety Plan for the site or which poses a threat to the health and safety of persons.
- 5.7 The Contractor shall ensure that a copy of the Health and Safety Plan is available on site for inspection by an inspector, Technical Officer, agent, subcontractor, employee, registered employee organisation, health and safety representative or any member of the health and safety committee.
- 5.8 The Contractor shall consult with the health and safety committee or, if no health and safety committee exists, with a representative group of employees, on the development, monitoring and review of the Risk Assessment.
- 5.9 The Contractor shall ensure that all employees under his control are informed, instructed and trained by a competent person regarding any hazard and the related work procedures before any work commences, and thereafter at such times as may be determined in the Risk Assessment.
- 5.10 The Contractor shall ensure that all subcontractors are informed regarding any hazard as stipulated in the Risk Assessment before any work commences, and thereafter at such times as may be determined in the Risk Assessment.
- 5.11 The Contractor shall ensure that all visitors to a construction site undergoes health and safety induction pertaining to the hazards prevalent on the site and shall be provided with the necessary personal protective equipment.
- 6. Fall Protection Plan**
- 6.1 In the event of the risk and hazard identification, as required in terms of clause 5.3 of this Specification, revealing risks relating to working from an elevated position the contractor shall cause the designation of a competent person, responsible for the preparation of a fall protection plan;

- 6.2 The Contractor shall implement, maintain and monitor the fall protection plan for the duration of Contract. The Contractor shall also take such steps to ensure the continued adherence to the fall protection plan.
- 6.3 The fall protection plan shall include:-
- (a) A Risk Assessment of all work carried out from an elevated position;
  - (b) the procedures and methods to address all the identified risks per location;
  - (c) the evaluation of the employees physical and psychological fitness necessary to work at elevated positions;
  - (d) the training of employees working from elevated positions; and
  - (e) the procedure addressing the inspection, testing and maintenance of all fall protection equipment.

## 7. Hazards and Potential Hazardous Situations

The Contractor and the Technical Officer shall immediately notify one another of any hazardous or potentially hazardous situations which may arise during performance of the Contract by the Contractor or any subcontractor and, in particular, of such hazards as may be caused by the design, execution and/or location and any other aspect pertaining to the contract work.

## 8. Health and Safety File

- 8.1 The Contractor shall ensure that a health and safety file is opened and kept on site and shall include all documentation required as per the Act and applicable regulations, and made available to an inspector, the Technical Officer, or subcontractor upon request.
- 8.2 The Contractor shall ensure that a copy of the both his Health and Safety Plan as well as any subcontractor's Health and Safety Plan is available on request to an employee, inspector, contractor or the Technical Officer.
- 8.3 The Contractor shall hand over a consolidated health and safety file to the Technical Officer upon completion of the Construction Work and shall in addition to documentation mentioned in the Act and applicable Regulations include a record of all drawings, designs, materials used and other similar information concerning the completed structure.

**ANNEXURE 1****OCCUPATIONAL HEALTH AND SAFETY ACT, 1993****Regulation 3(1) of the Construction Regulations****NOTIFICATION OF CONSTRUCTION WORK**

- 
- 
- 1(a) Name and postal address of principal contractor:  
\_\_\_\_\_
- (b) Name and tel. no of principal contractor's contact person:  
\_\_\_\_\_
2. Principal contractor's compensation registration number: \_\_\_\_\_
- 3(a) Name and postal address of client:  
\_\_\_\_\_
- (b) Name and tel no of client's contact person or agent:  
\_\_\_\_\_
- 4(a) Name and postal address of designer(s) for the project:  
\_\_\_\_\_
- (b) Name and tel. no of designer(s) contact person:  
\_\_\_\_\_
5. Name and telephone number of principal contractor's construction supervisor on site appointed in terms of regulation 6(1).  
\_\_\_\_\_
6. Name/s of principal contractor's construction sub-ordinate supervisors on site appointed in terms of regulation 6(2).  
\_\_\_\_\_
7. Exact physical address of the construction site or site office:  
\_\_\_\_\_  
\_\_\_\_\_  
\_\_\_\_\_
8. Nature of the construction work:  
\_\_\_\_\_  
\_\_\_\_\_  
\_\_\_\_\_  
\_\_\_\_\_
9. Expected commencement date: \_\_\_\_\_
10. Expected completion date: \_\_\_\_\_

11. Estimated maximum number of persons on the construction site: \_\_\_\_\_

12. Planned number of contractors on the construction site accountable to the principle contractor:

\_\_\_\_\_

13. Name(s) of contractors already chosen.

\_\_\_\_\_  
\_\_\_\_\_  
\_\_\_\_\_  
\_\_\_\_\_  
\_\_\_\_\_  
\_\_\_\_\_

\_\_\_\_\_

**Principal Contractor**

\_\_\_\_\_

**Date**

\_\_\_\_\_

**Client**

\_\_\_\_\_

**Date**

\* THIS DOCUMENT IS TO BE FORWARDED TO THE OFFICE OF THE DEPARTMENT OF LABOUR **PRIOR TO COMMENCEMENT** OF WORK ON SITE.

\* **ALL PRINCIPAL CONTRACTORS** THAT QUALIFY TO NOTIFY MUST DO SO EVEN IF ANOTHER PRINCIPAL CONTRACTOR ON THE SAME SITE HAD DONE SO PRIOR TO THE COMMENCEMENT OF WORK.

"PREPARED ONLY COPY"



**ANNEXURE 2****(COMPANY LETTER HEAD)****OCCUPATIONAL HEALTH AND SAFETY ACT, 1993 (ACT 85 OF 1993) :****SECTION/REGULATION:** \_\_\_\_\_**REQUIRED COMPETENCY:** \_\_\_\_\_

In terms of \_\_\_\_\_ I, \_\_\_\_\_

representing the Employer) do hereby appoint \_\_\_\_\_

As the Competent Person on the premises at \_\_\_\_\_

(physical address) to assist in compliance with the Act and the applicable Regulations.

Your designated area/s is/are as follows :-

---



---



---

**Date :** \_\_\_\_\_**Signature :-** \_\_\_\_\_**Designation :-** \_\_\_\_\_**ACCEPTANCE OF DESIGNATION**

I, \_\_\_\_\_ do hereby accept this Designation and acknowledge that I understand the requirements of this appointment.

**Date :** \_\_\_\_\_**Signature :-** \_\_\_\_\_**Designation :-** \_\_\_\_\_

**ANNEXURE 3****(COMPANY LETTER HEAD)****OCCUPATIONAL HEALTH AND SAFETY ACT, 1993 (ACT 85 OF 1993) :****DECLARATION**

In terms of the above Act I, \_\_\_\_\_ am personally assuming the duties and obligations as Chief Executive Officer, defined in Section 1 of the Act and in terms of Section 16(1), I will, as far as is reasonably practicable, ensure that the duties and obligations of the Employer as contemplated in the above Act are properly discharged.

*Signature :-* \_\_\_\_\_

*Date :* \_\_\_\_\_

"PREVIEW ONLY COPY"

**ANNEXURE 4****(LETTER HEAD OF BUSINESS DIVISION OR UNIT OF TRANSNET LIMITED)****SITE ACCESS CERTIFICATE**

Access to : \_\_\_\_\_ (Area)  
 Name of Contractor/Builder :- \_\_\_\_\_  
 Contract/Order No.: \_\_\_\_\_

The contract works site/area described above are made available to you for the carrying out of associated works

In terms of your contract/order with  
 (company) \_\_\_\_\_

Kindly note that you are at all times responsible for the control and safety of the Works Site, and for persons under your control having access to the site.

As from the date hereof you will be responsible for compliance with the requirements of the Occupational Health and Safety Act, 1993 (Act 85 of 1993) as amended, and all conditions of the Contract pertaining to the site of the works as defined and demarcated in the contract documents including the plans of the site or work areas forming part thereof.

Signed : \_\_\_\_\_ Date : \_\_\_\_\_  
**TECHNICAL OFFICER**

**ACKNOWLEDGEMENT OF RECEIPT**

Name of Contractor/Builder :- \_\_\_\_\_ I,  
 \_\_\_\_\_ do hereby acknowledge and accept the duties  
 and obligations in respect of the Safety of the site/area of Work in terms of the Occupational Health and  
 Safety Act; Act 85 of 1993.

Name : \_\_\_\_\_ Designation : \_\_\_\_\_

Signature : \_\_\_\_\_ Date : \_\_\_\_\_

E7/1 (July 1998)

SPECIFICATION FOR WORKS ON, OVER, UNDER OR ADJACENT TO RAILWAY LINES AND  
NEAR HIGH VOLTAGE EQUIPMENT

(This Specification shall be used in Transnet Contracts)

"PREVIEW ONLY COPY"

## CONTENTS

<u>CLAUSE NO'S</u>	<u>DESCRIPTION</u>	<u>PAGE</u>
1.	<b><u>DEFINITIONS</u></b>	3
	<b><u>PART A - GENERAL SPECIFICATION</u></b>	
2.	Authority of officers of Transnet	4
3.	Contractor's representatives	4
4.	Occupations and work permits	4
5.	Speed restrictions and protection	5
6.	Roads on Transnet property	5
7.	Clearances	5
8.	Stacking of material	5
9.	Excavation, shoring, dewatering and drainage	5
10.	Falsework for structures	6
11.	Piling	6
12.	Underground services	6
13.	Blasting	6
14.	Rail trolleys	7
15.	Signal track circuits	7
16.	Penalty for delays to trains	7
	<b><u>PART B - ADDITIONAL SPECIFICATION FOR WORK NEAR HIGH-VOLTAGE ELECTRICAL EQUIPMENT</u></b>	
17.	General	8
18.	Work on buildings of fixed structures	8
19.	Work done on or outside of rolling stock, including loading and unloading	8
20.	Use of equipment	9
21.	Carrying and handling material and equipment	9
22.	Precautions to be taken when erecting or removing poles, antennae and trees	10
23.	Use of water	10
24.	Use of construction plant	10
25.	Work performed under dead conditions under cover of a work permit	10
26.	Traction return circuits in rails	11
27.	Blasting	11
28.	High-voltage electrical equipment not maintained and/or operated by Transnet	11
	<b><u>ANNEXES</u></b>	
1.	Horizontal clearances 1 065 mm gauge	
2.	Vertical clearances 1 065 mm gauge	
3.	Clearances 610 mm gauge	
4.	Platform clearances	

## **DEFINITIONS**

The following definitions shall apply :

Authorised Person. A person whether an employee of Transnet or not, who has been specially authorised to undertake specific duties in terms of Transnet's publication SAFETY INSTRUCTIONS: HIGH-VOLTAGE ELECTRICAL EQUIPMENT, and who holds a certificate or letter of authority to that effect.

Barrier. Any device designed to restrict access to "live" high-voltage electrical equipment.

Bond. A short conductor installed to provide electrical continuity.

Contractor. Any person or organisation appointed by Transnet to carry out work on its behalf.

Dead. Isolated and earthed.

Electrical Officer (Contracts). The person appointed in writing by the responsible Electrical Engineer in Transnet as the person who shall be consulted by the Contractor in all electrical matters to ensure that adequate safety precautions are taken by the Contractor.

Executive Officer. The person appointed by Transnet from time to time as the Executive Officer to act according to the rights and powers held by and obligations placed upon him in terms of the Contract.

High-Voltage. A voltage normally exceeding 1 000 volts.

Live. A conductor is said to be "live" when it is at a potential different from that of the earth or any other conductor of the system of which it forms a part.

Near. To be in such a position that a person's body or the tools he is using or any equipment he is handling may come within 3 metres of live exposed high-voltage electrical equipment.

Occupation. An authorisation granted by Transnet for work to be carried out under specified conditions on, over under or adjacent to railway lines.

Occupation Between Trains. An occupation during an interval between successive trains.

Project Manager. The person or juristic person appointed by Transnet from time to time as the Project Manager, to administer the Contract according to the powers and rights held by and obligations placed upon him in terms of the Contract.

Responsible Representative. The responsible person in charge, appointed by a contractor, who has undergone specific training (and holds a certificate) to supervise staff under his control to work on, over, under or adjacent to railway lines and in the vicinity of high-voltage electrical equipment.

Technical Officer. The person or juristic person appointed by Transnet from time to time as the Technical Officer, to administer the Contractor's performance and execution of the Works according to the powers and rights held by and obligations placed upon the Technical Officer in terms of the Contract.

Total Occupation. An occupation for a period when trains are not to traverse the section of line covered by the occupation.

Work on. Work undertaken on or so close to the equipment that the specified working clearances to the live equipment cannot be maintained.

Work Permit. A combined written application and authority to proceed with work on or near dead electrical equipment.

## **PART A - GENERAL SPECIFICATION**

### **2. AUTHORITY OF OFFICERS OF TRANSNET**

- 2.1 The Contractor shall co-operate with the officers of Transnet and shall comply with all instructions issued and restrictions imposed with respect to the Works which bear on the existence and operation of Transnet's railway lines and high-voltage equipment.
- 2.2 Without limiting the generality of the provisions of 2.1, any duly authorised representative of Transnet, having identified himself, may stop the work if, in his opinion, the safe passage of trains or the safety of Transnet assets or any person is affected. **CONSIDERATIONS OF SAFETY SHALL TAKE PRECEDENCE OVER ALL OTHER CONSIDERATIONS.**

### **3. CONTRACTOR'S REPRESENTATIVES**

- 3.1 The Contractor shall nominate Responsible Representatives of whom at least one shall be available at any hour for call-out in cases of emergency. The Contractor shall provide the Technical Officer with the names, addresses and telephone numbers of the representatives.
- 3.2 The Contractor guarantees that he has satisfied himself that the Responsible Representative is fully conversant with this specification and that he shall comply with all his obligations in respect thereof.

### **4. OCCUPATIONS AND WORK PERMITS**

- 4.1 Work to be done during total occupation or during an occupation between trains or under a work permit shall be done in a manner decided by the Technical Officer and at times to suit Transnet requirements.
- 4.2 The Contractor shall organise the Works in a manner, which will minimise the number and duration of occupations and work permits required.
- 4.3 Transnet will not be liable for any financial or other loss suffered by the Contractor arising from his failure to complete any work scheduled during the period of an occupation or work permit.
- 4.4 The Contractor shall submit to the Technical Officer, in writing, requests for occupations or work permits together with details of the work to be undertaken, at least 14 days before they are required. Transnet does not undertake to grant an occupation or work permit for any particular date, time or duration.
- 4.5 Transnet reserves the right to cancel any occupation or work permit at any time before or during the period of occupation or work permit. If, due to cancellation or change in date or time, the Contractor is not permitted to start work under conditions of total occupation or work permit at the time arranged, all costs caused by the cancellation shall be born by the Contractor except as provided for in clauses 4.6 to 4.8.

- 4.6 When the Contractor is notified less than 2 hours before the scheduled starting time that the occupation or work permit is cancelled, he may claim reimbursement of his direct financial losses caused by the loss of working time up to the time his labour and plant are employed on other work, but not exceeding the period of the cancelled occupation or work permit.
- 4.7 When the Contractor is notified less than 2 hours before the schedule starting time, or during an occupation or work permit, that the duration of the occupation or work permit is reduced, he may claim reimbursement of his direct financial losses caused by the loss of working time due to the reduced duration of the occupation or work permit.
- 4.8 Reimbursement the Contractor for any loss of working time in terms of 4.6 and 4.7, shall be subject to his claims being submitted within 14 days of the event with full details of labour and plant involved, and provided that the Technical Officer certifies that no other work on which the labour and plant could be employed was immediately available.
- 4.9 Before starting any work for which an occupation has been arranged, the Contractor shall obtain from the Technical Officer written confirmation of the date, time and duration of the occupation.
- 4.10 Before starting any work for which a work permit has been arranged, the Responsible Representative shall read and sign portion C of form No. T.1276 signifying that he is aware of the limits within which work may be undertaken. After the work for which the permit was granted has been completed, or when the work permit is due to be terminated, or if the permit is cancelled after the start, the same person who signed portion C shall sign portion D of the T.1276 form, thereby acknowledging that he is aware that the electrical equipment is to be made "live". The Contractor shall advise all his workmen accordingly.

5. **SPEED RESTRICTIONS AND PROTECTION**

- 5.1 When speed restrictions are imposed by Transnet because of the Contractor's activities, the Contractor shall organise and carry out his work so as to permit the removal of the restrictions as soon as possible.
- 5.2 When the Technical Officer considers protection to be necessary the Contractor shall, unless otherwise agreed, provide all protection including flagmen, other personnel and all equipment for the protection of Transnet's and the Contractor's personnel and assets, the public and including trains. Transnet will provide training free of charge of the Contractor's flagmen and other personnel performing protection duties. The Contractor shall consult with the Technical Officer, whenever he considers that protection will be necessary, taking into account the minimum permissible clearances set out in appendixes 1 to 4.
- 5.3 The Contractor shall appoint a Responsible Representative to receive and transmit any instruction, which may be given by Transnet personnel providing protection.

6. **ROADS ON TRANSNET PROPERTY**

The provision of clause 25 of the E.5, General Conditions of Contract, or clause 23 of the E.5 (MW), General Conditions of Contract for Maintenance Works, shall apply to the use of existing roads on Transnet's property.



7. **CLEARANCES**

7.1 No temporary works shall encroach on the appropriate minimum clearances set out in Annexure 1 BE97-01 Sheets 1,2, 3 and 5 of 5.

8. **STACKING OF MATERIAL**

8.1 The Contractor shall not stack any material closer than 3 m from the centre line of any railway line without prior approval of the Technical Officer.

9. **EXCAVATION, SHORING, DEWATERING AND DRAINAGE**

9.1 Unless otherwise approved by the Technical Officer any excavation adjacent to a railway line shall not encroach on the hatched area shown in Figure 1.

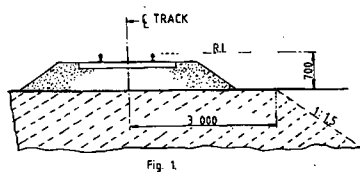

9.2 The Contractor shall provide at his own cost any shoring, dewatering or drainage of any excavation unless otherwise stipulated elsewhere in the Contract.

9.3 Where required by the Technical Officer, drawings of shoring for any excavation under or adjacent to a railway line shall be submitted and permission to proceed obtained, before the excavation is commenced.

9.4 The Contractor shall prevent ingress of water to the excavation but where water does enter, he shall dispose of it as directed by the Technical Officer.

9.5 The Contractor shall not block, obstruct or damage any existing drains either above or below ground level unless he has made adequate prior arrangements to deal with drainage.

10. **FALSEWORK FOR STRUCTURES**

10.1 Drawings of falsework for the construction of any structure over, under or adjacent to any railway line shall be submitted to the Technical Officer and his permission to proceed obtained before the falsework is erected. Each drawing shall be given a title and a distinguishing number and shall be signed by a registered professional engineer certifying that he has checked the design of the falsework and that the drawings are correct and in accordance with the design.

10.2 After the falsework has been erected and before any load is applied, the Contractor shall submit to the Technical Officer a certificate signed by a registered professional engineer certifying that he has checked the falsework and that it has been erected in accordance with the drawings. Titles and numbers of the drawings shall be stated in the certificate. Notwithstanding permission given by the Technical Officer to proceed, the Contractor shall be entirely responsible for the safety and adequacy of the falsework.

11. **PILING**

11.1 The Technical Officer will specify the conditions under which piles may be installed on Transnet property.

12. **UNDERGROUND SERVICES**

12.1 No pegs or stakes shall be driven or any excavation made before the Contractor has established that there are no underground services, which may be damaged thereby.

12.2 Any damage shall be reported immediately to the Technical Officer, or to the official in charge at the nearest station, or to the traffic controller in the case of centralised traffic control.

13. **BLASTING**

13.1 The provisions of clause 23 of the E.5, General Conditions of Contract or clause 21 of the E.5 (MW), General Conditions of Contract for Maintenance Work, shall apply to all blasting operations undertaken in terms of the Contract.

13.2 The Contractor shall provide proof that he has complied with the provisions of clauses 10.17.1 to 10.17.4 of the Explosives Regulations (Act 26 of 1956 as amended).

13.3 Blasting within 500m of a railway line will only be permitted during intervals between trains. A person appointed by the Technical Officer, assisted by flagmen with the necessary protective equipment, will be in communication with the controlling railway station. Only this person will be authorised to give the Contractor permission to blast, and the Contractor shall obey his instructions implicitly regarding the time during which blasting may take place.

13.4 The flagmen described in 13.3, where provided by Transnet, are for the protection of trains and Transnet property only, and their presence does not relieve the Contractor in any manner of his responsibilities in terms of Explosives Act or Regulations, or any obligation in terms of this Contract.

13.5 The person described in 13.3 will record in a book provided and retained by Transnet the dates and times -

(i) when each request is made by him to the controlling station for permission to blast;

(ii) when blasting may take place;

(iii) when blasting actually takes place; and

(iv) when he advises the controlling station that the line is safe for the passage of trains.

13.6 Before each blast the Contractor shall record in the same book, the details of the blast to be carried out. The person appointed by the Technical Officer and the person who will do the blasting shall both sign the book whenever an entry described in 13.5 is made.

13.7 The terms of clause 27 hereof shall be strictly adhered to.

14. **RAIL TROLLEYS**

14.1 The use of rail trolleys or trestle trolleys on a railway line for working on high voltage equipment will be permitted only if approved by the Technical Officer and under the conditions stipulated by him.

14.2 All costs in connection with such trolley working requested by the Contractor shall, unless otherwise agreed, be borne by the Contractor, excluding the costs of any train protection services normally provided free of charge by Transnet.

15. **SIGNAL TRACK CIRCUITS**

15.1 Where signal track circuits are installed, the Contractor shall ensure that no material capable of conducting an electrical current makes contact between rails of a railway line/lines.

15.2 No signal connections on track-circuited tracks shall be severed without the Technical Officer's knowledge and consent.

16. **PENALTY FOR DELAYS TO TRAINS**

16.1 If any trains are delayed by the Contractor and the Technical Officer is satisfied that the delay was avoidable, a penalty will be imposed on the Contractor of R5 000 per hour or part thereof for the period of delay, irrespective of the number of trains delayed.

"PREVIEW ONLY COPY"

**PART B - ADDITIONAL SPECIFICATION FOR WORK NEAR HIGH-VOLTAGE ELECTRICAL EQUIPMENT**

17. **GENERAL**

- 17.1 This specification is based on the contents of Transnet's publication SAFETY INSTRUCTIONS, HIGH-VOLTAGE ELECTRICAL EQUIPMENT, as amended, a copy of which will be made available on loan to the Contractor for the duration of the contract. These instructions apply to all work near live high-voltage equipment maintained and/or operated by Transnet, and the onus rests on the Contractor to ensure that he obtains a copy.
- 17.2 The Contractor's attention is drawn in particular to the contents of Part I, Sections 1 and 2 of the Safety Instructions : High-Voltage Electrical Equipment.
- 17.3 The Safety Instructions : High-Voltage Electrical Equipment cover the minimum safety precautions which must be taken to ensure safe working on or near high-voltage electrical equipment, and must be observed at all times. Should additional safety measures be considered necessary because of peculiar local conditions, these may be ordered by and at the discretion of the Electrical Officer (Contracts).
- 17.4 This specification must be read in conjunction with and not in lieu of the Safety Instructions : High-Voltage Electrical Equipment.
- 17.5 The Contractor shall obtain the approval of the Electrical Officer (Contracts) before any work is done which causes or could cause any portion of a person's body or the tools he is using or any equipment he is handling, to come within 3 metres of any live high-voltage equipment.
- 17.6 The Contractor shall regard all high-voltage equipment as live unless a work permit is in force.
- 17.7 Safety precautions taken or barriers erected shall comply with the requirements of the Electrical Officer (Contracts), and shall be approved by him before the work to be protected is undertaken by the Contractor. The Contractor shall, unless otherwise agreed, bear the cost of the provision of the barriers and other safety precautions required, including the attendance of Transnet staff where this is necessary.
- 17.8 No barrier shall be removed unless authorised by the Electrical Officer (Contracts).

18. **WORK ON BUILDINGS OR FIXED STRUCTURES**

- Before any work is carried out or measurements are taken on any part of a building, fixed structure or earthworks of any kind above ground level situated within 3 metres of live high-voltage equipment, the Electrical Officer (Contracts) shall be consulted to ascertain the conditions under which the work may be carried out.
- 18.2 No barrier erected to comply with the requirements of the Electrical Officer (Contracts) shall be used as temporary staging or shuttering for any part of the Works.
- 18.3 The shuttering for bridge piers, abutments, retaining walls or parapets adjacent to or over any

track may be permitted to serve as a barrier, provided that it extends at least 2,5 metres above any working level in the case of piers, abutments and retaining walls and 1,5 metres above any working level in the case of parapets.

## 19. **WORK DONE ON OR OUTSIDE OF ROLLING STOCK, INCLUDING LOADING OR UNLOADING**

19.1 No person shall stand, climb or work whilst on any platform, surface or foothold higher than the normal unrestricted places of access, namely -

- (i) the floor level of trucks;
- (ii) external walkways on diesel, steam and electric locomotives, steam heat vans, etc. and
- (iii) walkways between coaches and locomotives.

When in these positions, no person may raise his hands or any equipment or material he is handling above his head.

19.2 In cases where the Contractor operates his own rail mounted equipment, he shall arrange for the walkways on this plant to be inspected by the Electrical Officer (Contracts) and approved, before commencement of work.

19.3 The handling of long lengths of material such as metal pipes, reinforcing bars, etc should be avoided, but if essential they shall be handled as nearly as possible in a horizontal position below head height.

19.4 The Responsible Representative shall warn all persons under his control of the danger of being near live high-voltage equipment, and shall ensure that the warning is fully understood.

19.5 Where the conditions in 19.1 to 19.3 cannot be observed the Electrical Officer (Contracts), shall be notified. He will arrange for suitable Safety measures to be taken. The Electrical Officer (Contracts), may in his discretion and in appropriate circumstances, arrange for a suitable employee of the Contractor to be specially trained by Transnet and at its costs, as an Authorised Person to work closer than 3 metres from live overhead conductors and under such conditions as may be imposed by the Senior responsible Electrical Engineer in Transnet.

## 20. **USE OF EQUIPMENT**

20.1 Measuring Tapes and Devices

20.1.1 Measuring tapes may be used near live high-voltage equipment provided that no part of any tape or a person's body comes within 3 metres of the live equipment.

20.1.2 In windy conditions the distance shall be increased to ensure that if the tape should fall it will not be blown nearer than 3 metres from the live high-voltage equipment.

- 20.1.3 Special measuring devices longer than 2 metres such as survey staves and rods may be used if these are of non-conducting material and approved by the responsible Electrical Engineer in Transnet, but these devices must not be used within 3 metres of live high-voltage equipment in rainy or wet conditions.
- 20.1.4 The assistance of the Electrical Officer (Contracts) shall be requested when measurements within the limits defined in 20.1.1 to 20.1.3 are required.
- 20.1.5 The restrictions described in 20.1.1 to 20.1.3 do not apply on a bridge deck between permanent parapets nor in other situations where a barrier effectively prevents contact with the live high-voltage equipment.

## 20.2 Portable Ladders

- 20.2.1 Any type of portable ladder longer than 2 metres may only be used near live high-voltage equipment under the direct supervision of the Responsible Representative. He shall ensure that the ladder is always used in such a manner that the distance from the base of the ladder to any live high-voltage equipment is greater than the fully extended length of the ladder plus 3 metres. Where these conditions cannot be observed, the Electrical Officer (Contracts) shall be advised, and he will arrange for suitable safety measures to be taken.

## 21. CARRYING AND HANDLING MATERIAL AND EQUIPMENT

- 21.1 Pipes, scaffolding, iron sheets, reinforcing bars and other material, which exceeds 2 metres in length, shall be carried completely below head height near live high-voltage equipment. For maximum safety two or more persons so as to maintain it as nearly as possible in a horizontal position should carry such material. The utmost care must be taken to ensure that no part of the material comes within 3 metres of any live high-voltage equipment.
- 21.2 Long lengths of wire or cable shall never be run out in conditions where a part of a wire or cable can come within 3 metres of any live high-voltage equipment unless the Electrical Officer (Contracts) has been advised and has approved appropriate safety precautions.
- 21.3 The presence of overhead power lines shall always be taken account of especially when communications lines or cables or aerial cables, stay wires, etc. are being erected above ground level.

## 22. PRECAUTIONS TO BE TAKEN WHEN ERECTING OR REMOVING POLES, ANTENNAE, TREES ETC.

- 22.1 A pole may be handled for the purpose of erection or removal near high-voltage equipment under the following conditions:
- (i) If the distance between the point at which the pole is to be erected or removed and the nearest live high-voltage equipment is more than the length of the pole plus 3 metres, the work shall be supervised by the Responsible Representative.

- (ii) If the distance described in (i) is less than the length of the pole plus 3 metres, the Electrical Officer (Contracts) shall be consulted to arrange for an Authorised Person to supervise the work and to ensure that the pole is earthed where possible. The pole shall be kept in contact with the point of erection, and adequate precautions shall be taken to prevent contact with live high-voltage equipment.

22.2 The cost of supervision by an Authorised Person and the provision of earthing shall, unless otherwise agreed, be borne by the Contractor.

22.3 The provisions of clauses 22.1 and 22.2 shall also apply to the erection or removal of columns, antennae, trees, posts, etc.

23. **USE OF WATER**

23.1 No water shall be used in the form of a jet if it can make contact with any live high-voltage equipment or with any person working on such equipment.

24. **USE OF CONSTRUCTION PLANT**

24.1 "Construction plant" entails all types of plant including cranes, piling frames, boring machines, excavators, draglines, dewatering equipment and road vehicles with or without lifting equipment.

24.2 When work is being undertaken in such a position that it is possible for construction plant or its load to come within 3 metres of live high-voltage equipment, the Electrical Officer (Contracts) shall be consulted. He will arrange for an Authorised Person to supervise the work and to ensure that the plant is adequately earthed. The Electrical Officer (Contracts) will decide whether further safety measures are necessary.

24.3 The cost of any supervision by an Authorised Person and the provision of earthing shall, unless otherwise agreed, be borne by the Contractor.

24.4 When loads are handled by cranes, non-metallic rope hand lines shall be used, affixed to such loads so as to prevent their swinging and coming within 3 metres of live high-voltage equipment.

24.5 Clauses 24.1 to 24.4 shall apply mutatis mutandis to the use of maintenance machines of any nature.

25. **WORK PERFORMED UNDER DEAD CONDITIONS UNDER COVER OF A WORK PERMIT**

25.1 If the Responsible Representative finds that the work cannot be done in safety with the high-voltage electrical equipment live, he shall consult the Electrical Officer (Contracts) who will decide on the action to be taken.

25.2 If a work permit is issued the Responsible Representative shall -

- (i) before commencement of work ensure that the limits within which work may be carried out

have been explained to him by the Authorised Person who issued the permit to him, and that he fully understands these limits.

- (ii) sign portion C of the permit before commencement of work;
- (iii) explain to all persons under his control the limits within which work may be carried out, and ensure that they fully understand these limits;
- (iv) care for the safety of all persons under his control whilst work is in progress; and
- (v) withdraw all personnel under his control from the equipment on completion of the work before he signs portion D of the work permit.

26. **TRACTION RETURN CIRCUITS IN RAILS**

26.1 DANGEROUS CONDITIONS CAN BE CREATED BY REMOVING OR SEVERING ANY BOND.

26.2 Broken rails with an air gap between the ends, and joints, at which fishplates are removed under "broken bond" conditions, are potentially lethal. The rails on either side of an air gap between rail ends on electrified lines shall not be touched simultaneously until rendered safe by Transnet personnel.

26.3 The Contractor shall not break any permanent bonds between rails or between rails and any structure. He shall give the Technical Officer at least 7 days written notice when removal of such bonds is necessary.

26.4 No work on the track which involves interference with the traction return rail circuit either by cutting or removing the rails, or by removal of bonds shall be done unless the Electrical Officer (Contracts) is consulted. He will take such precautions as may be necessary to ensure continuity of the return circuit before permitting the work to be commenced.

27. **BLASTING**

27.1 The Contractor shall obtain the permission of the Electrical Officer (Contracts) before blasting, and shall give at least 14 days notice of his intention to blast.

27.2 No blasting shall be done in the vicinity of electrified lines unless a member of Transnet's electrical personnel is present.

27.3 The terms of clause 13 hereof shall be strictly adhered to.



28. **HIGH-VOLTAGE ELECTRICAL EQUIPMENT NOT MAINTAINED AND/OR OPERATED BY TRANSNET**

Where the work is undertaken on or near high-voltage electrical equipment which is not maintained and/or operated by Transnet, the Occupational Health and Safety Act No. 85 of 1993, and Regulations and Instructions, or the Mines Health and Safety Act (Act 29 of 1996), shall apply.

Such equipment includes: -

- (i) Eskom and municipal equipment;
- (ii) the Contractor's own power supplies; and
- (iii) electrical equipment being installed but not yet taken over from the Contractor.

"PREVIEW ONLY COPY"

RADIUS (m)	WITH CANT		NO CANT	WITH CANT	
	H (mm)	L (mm)	H & L	B (mm)	C (mm)
90	2 730	3 090	2 780	1 130	2 100
100	2 700	3 030	2 750	1 140	2 050
120	2 650	2 970	2 700	1 160	2 010
140	2 620	2 920	2 660	1 175	1 990
170	2 590	2 870	2 630	1 190	1 970
200	2 570	2 820	2 600	1 205	1 950
250	2 550	2 790	2 580	1 230	1 920
300	2 540	2 760	2 580	1 250	1 900
350	2 530	2 730	2 540	1 270	1 890
400	2 520	2 710	2 530	1 290	1 875
500	2 510	2 680	2 520	1 320	1 850
600	2 500	2 660	2 510	1 340	1 830
800	2 490	2 620	2 500	1 365	1 790
1 000	2 480	2 600	2 490	1 380	1 760
1 200	2 480	2 580	2 490	1 200	1 730
1 500	2 480	2 550	2 480	1 415	1 700
2 000	2 480	2 500	2 480	1 440	1 660
3 000	2 470	2 470	2 470	1 500	1 600
>5 000	2 460	2 460	2 460	1 600	1 600

## REMARKS:

- H AND B IS THE REQUIRED HORIZONTAL CLEARANCE ON THE OUTSIDE OF THE CURVE BASED ON MINIMUM CANT.
- L AND C IS THE REQUIRED HORIZONTAL CLEARANCE ON THE INSIDE OF THE CURVE BASED ON MAXIMUM CANT.
- INTERMEDIATE VALUES MAY BE INTERPOLATED BY THE ENGINEER IN CHARGE.
- FOR WORKSHOP AREAS AND TEMPORARY WORK, CLEARANCES H AND L MAY BE REDUCED BY 300mm.
- ⊕ SEE ANNEXURE 1 SHEET 3 FOR PLATFORM CLEARANCES.
- ALSO REFER TO REMARKS 4 TO 8 OF ANNEXURE 1 SHEET 2.

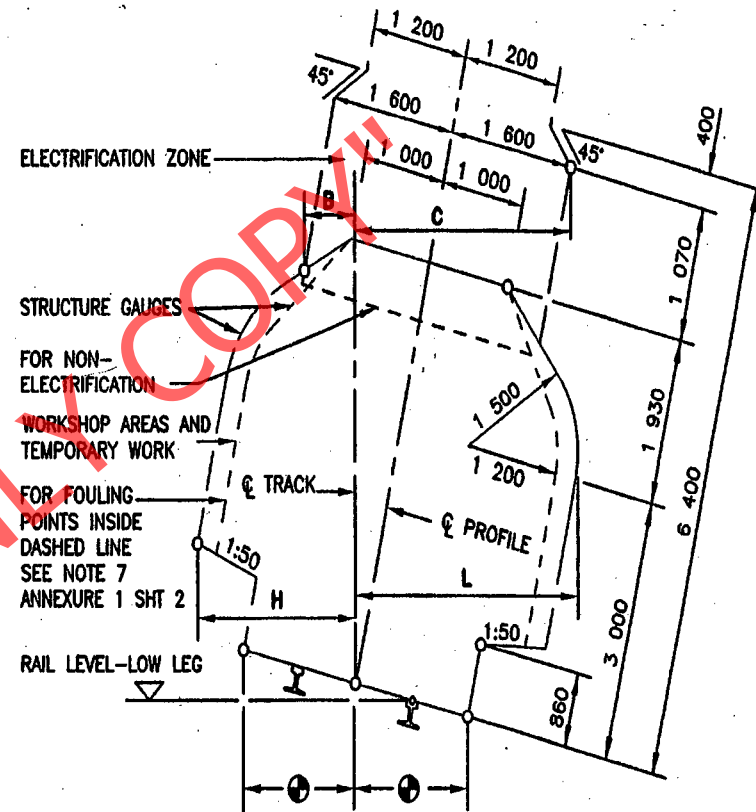

BE 97-01 Sht 2 of 5 DATE : JUNE 2000

LOCATION	RADIUS (mm)	NOT ELECTRIFIED S (mm)	ELECTRIFIED (PRESENT OR FUTURE)	
			3kV & 25kV V (mm)	50kV V (mm)
ALL AREAS OTHER THAN THOSE INDICATED BY * BELOW	100	4 470	5 050	5 400
	300	4 410	5 020	5 370
	600	4 370	5 000	5 350
	1 000	4 350	4 990	5 340
	1 500	4 310	4 960	5 310
	2 000	4 290	4 940	5 290
	>3 000	4 270	4 930	5 280
* OVER OR NEAR POINTS AND CROSSING IF REQUIRED BY ELECTRICAL IRRESPECTIVE OF RADIUS			5 650	6 000

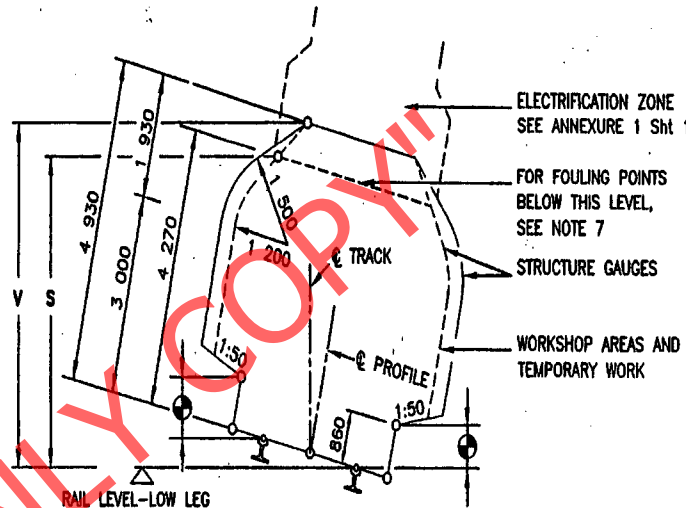

REMARKS:

1. V IS THE REQUIRED VERTICAL CLEARANCE EXCEPT WHERE REDUCED CLEARANCE S APPLIES.
2. S IS THE MINIMUM VERTICAL CLEARANCE FOR STRUCTURES AND TEMPORARY WORK OVER NON-ELECTRIFIED LINES.
3. INTERMEDIATE VALUES MAY BE INTERPOLATED BY THE ENGINEER IN CHARGE.
4. FOR APPLICATION AT CURVES
  - 4.1 APPLY INCREASED CLEARANCES FOR CURVES TO POINTS 3m BEYOND THE ENDS OF THE CIRCULAR CURVE.
  - 4.2 REDUCE CLEARANCES AT A UNIFORM RATE OVER THE REMAINDER OF THE TRANSITION CURVE.
  - 4.3 FOR NON-TRANSITIONED CURVES REDUCE AT A UNIFORM RATE OVER A LENGTH OF 15m ALONG STRAIGHTS.
5. NEW STRUCTURES: SEE BRIDGE CODE.
6. TUNNELS: SEE DRAWING BE 82-35.
7. FOULING POINTS: SEE CLAUSE 8.1.
8. CLEARANCES ARE BASED ON 15m BOGIE CENTRES AND 21,2m VEHICLE BODY LENGTH.
9. ⚡ SEE ANNEXURE 1 SHEET 3 FOR PLATFORM CLEARANCES.

ANNEXURE 1  
SHEET 2 of 5  
AMENDMENT

VERTICAL CLEARANCES :  
1 065mm TRACK GAUGE

PLATFORMS : TRACK GAUGE 1 085mm

PASSENGERS

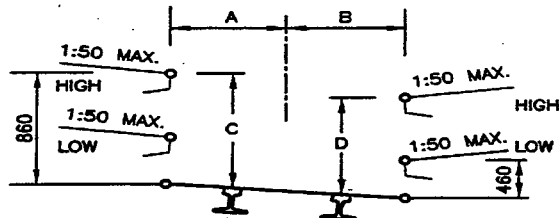

GOODS

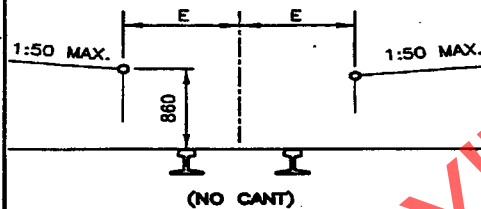

RADIUS (m)	A (mm)	B (mm)	C (mm)	D (mm)	E (mm)
90	1 690	1 820	890	810	1 840
100	1 650	1 790	890	810	1 810
120	1 610	1 740	890	810	1 760
140	1 580	1 700	890	810	1 720
170	1 550	1 660	890	810	1 690
200	1 530	1 630	890	820	1 670
250	1 520	1 600	890	820	1 640
300	1 520	1 580	890	830	1 620
350	1 520	1 560	880	830	1 600
400	1 520	1 550	880	840	1 590
500	1 520	1 540	880	850	1 580
600	1 520	1 530	870	850	1 570
800	1 520	1 520	860	860	1 560
1 200	1 520	1 520	860	860	1 550
2 000	1 520	1 520	860	860	1 540
3 000	1 520	1 520	860	860	1 530
STRAIGHT	1 520	1 520	860	860	1 520

REMARKS:

1. NO CANT TO BE APPLIED EXCEPT WHEN THE GOODS PLATFORM IS ON A RUNNING LINE.
2. INTERMEDIATE VALUES MAY BE INTERPOLATED BY THE ENGINEER IN CHARGE.
3. 8m TO MAIN STATION-BUILDINGS AND 3m TO ALL OTHER STRUCTURES.
4. TOLERANCES : SEE CLAUSE 8.0.10.

STRUCTURES ON PLATFORMS : 1 065mm AND 610mm TRACK GAUGE

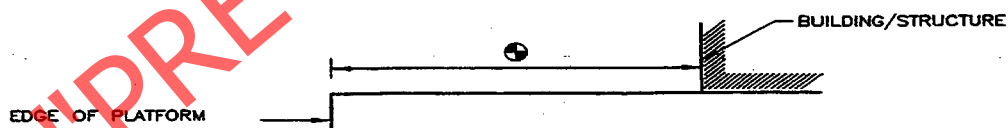

RADIUS (m)	WITH CANT		NO CANT	V (mm)
	H (mm)	L (mm)	H & L (mm)	
50	2 370	2 490	2 400	4 320
70	2 310	2 420	2 330	4 310
100	2 260	2 370	2 280	4 310
140	2 220	2 340	2 250	4 310
200	2 200	2 300	2 220	4 300
300	2 190	2 270	2 200	4 300
500	2 180	2 230	2 190	4 290
700	2 170	2 200	2 180	4 270
1 000	2 170	2 170	2 170	4 270
>2 000	2 160	2 160	2 160	4 270

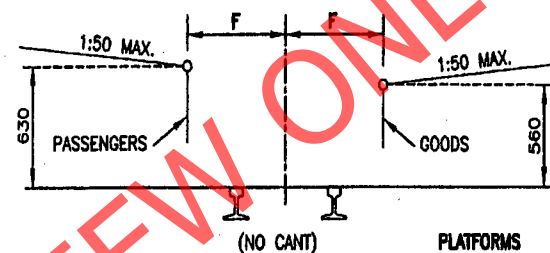
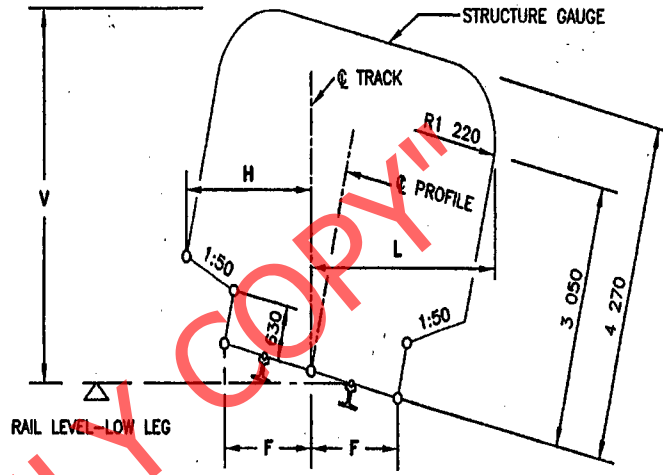

- REMARKS:**
- H IS THE MINIMUM HORIZONTAL CLEARANCE ON THE OUTSIDE OF THE CURVE BASED ON MINIMUM CANT.
  - L IS THE MINIMUM HORIZONTAL CLEARANCE ON THE INSIDE OF THE CURVE BASED ON MAXIMUM CANT.
  - V IS THE MINIMUM VERTICAL CLEARANCE.
  - FOR APPLICATION AT CURVES:
    - 4.1 APPLY INCREASED CLEARANCES FOR CURVES TO POINTS 2m BEYOND THE ENDS OF THE CIRCULAR CURVE.
    - 4.2 REDUCE CLEARANCES AT A UNIFORM RATE OVER THE REMAINDER OF THE TRANSITION CURVE.
    - 4.3 FOR NON-TRANSITIONED CURVES REDUCE AT A UNIFORM RATE OVER A LENGTH OF 18m ALONG STRAIGHTS.
  - INTERMEDIATE VALUES MAY BE INTERPOLATED BY THE ENGINEER IN CHARGE.
  - ALSO REFER TO REMARKS 5, 6 AND 7 OF ANNEXURE 1 SHEET 2.
  - CLEARANCES ARE BASED ON 9 700mm BOGIE CENTRES AND 13 700mm VEHICLE BODY LENGTH.
  - SEE ANNEXURE 1 SHEET 3 FOR STRUCTURES ON PLATFORMS.

RADIUS (m)	F (mm)
50	1 550
60	1 510
80	1 460
100	1 430
120	1 410
140	1 390
170	1 380
200	1 370
250	1 360
300	1 350
600	1 330
1 000	1 320
>2 000	1 320
STRAIGHT	1 310

ANNEXURE 1  
SHEET 5 of 5  
AMENDMENT

CLEARANCES : 610mm TRACK GAUGE