

ADVERT FOR REQUEST FOR QUOTATION

RFQ ERACES3184-18329

Transnet Freight Rail a Division of Transnet SOC Ltd. invites all interested parties to respond to a request for quotation (RFQ) as indicated below:

All RFQ's should be submitted on the appropriate RFQ forms and should be deposited in the tender box before 10h00 on the closing date of the tender/s.

If delivered by hand, the Tender submissions must be addressed to The Chairman Transnet Freight Rail Acquisition Council, Ground Floor, Inyanda House 1, 21 Wellington Road Parktown, Johannesburg, 2001.

RFQ documents may be obtained on and after **Tuesday, 14 July 2015** at the Reception, Tender Advice Centre, Inyanda House 1, Ground Floor, 21 Wellington Road, Parktown, Johannesburg and will **only be** available until **15h00** on **Monday, 20 July 2015**.

The tender is free of charge.

For enquiries regarding collection of documents, contact Anton Erasmus, telephone No. 011 584-9231 or Morris Mhlongo telephone 011 584 9230

RFQ documents may be viewed from the website by clicking on the RFQ number that is highlighted in red on the website: (<http://www.transnetfreightrail.co.za/website/tenders.html>)

RFQ NUMBER: ERACES3184-18329

SERVICES REQUIRED AT: KOEDOESPOORT DEPOT (SIGNALS) REPLACE SIGNAL POWER EQUIPMENT

CLOSING DATE: 28-07-2015 (10H00)

A compulsory information briefing session will be conducted at Transnet Freight Rail, at 10h00 on the 21st July 2015, at Signal Relay Room, Bon Accord Station, on the side of R101 Hammanskraal Road

Contact person for technical and directions: Mr Poppie Legodi Tel: 012 842 5310 / Mr Pieter Doorewaard cellphone 083 283 3885.

A Certificate of Attendance in the form set out in **Section 8** hereto must be completed and submitted with your Quotation as proof of attendance is required for a compulsory site meeting and/or RFQ briefing.

- Respondents failing to attend the compulsory RFQ briefing will be disqualified.
- The briefing session will start punctually at **10h00** and information will not be repeated for the benefit of Respondents arriving late.
- Reflective Jackets and Safety Shoes to be worn when visiting the site. Without the safety clothing, respondents won't be allowed at the various sites

For commercial enquiries contact: Edwin Senne

E-Mail: Edwin.senne@transnet.net

TEL: (012) 315 2137

Transnet Freight Rail urges Clients & Suppliers to report fraud/corruption at Transnet to TIPOFFS ANONYMOUS:

**FREIGHT RAIL**

An Operating Division of **TRANSNET SOC LTD**

[Registration No. 1990/000900/30]

REQUEST FOR QUOTATION [RFQ]

RFQ FOR KOEDOESPOORT DEPOT (SIGNALS) REPLACE SIGNAL POWER EQUIPMENT

RFQ NUMBER	ERACES3184-10379
ISSUE DATE:	14 JULY 2015
CLOSING DATE:	28 JULY 2015
CLOSING TIME:	10 00
BID VALIDITY PERIOD:	30 OCTOBER 2015

"PREVIEW COPY ONLY"

SCHEDULE OF BID DOCUMENTS

Section No	Page
SECTION 1: NOTICE BIDDERS.....	3
1 INVITATION TO BID.....	3
2 FORMAL BRIEFING.....	3
3 QUOTATION SUBMISSION.....	4
4 DELIVERY INSTRUCTIONS FOR RFQ.....	4
5 BROAD-BASED BLACK ECONOMIC EMPOWERMENT AND SOCIO-ECONOMIC OBLIGATIONS.....	5
6 COMMUNICATION.....	6
7 CONFIDENTIALITY.....	6
8 INSTRUCTIONS FOR COMPLETING THE RFQ.....	7
9 COMPLIANCE.....	7
10 DISCLAIMERS.....	7
11 LEGAL REVIEW.....	8
SECTION 1: SCOPE OF REQUIREMENTS.....	9
1 SCOPE OF REQUIREMENTS.....	9
2 GREEN ECONOMY / CARBON FOOTPRINT.....	12
3 GENERAL SERVICE PROVIDER OBLIGATIONS.....	12
4 EVALUATION METHODOLOGY.....	13
SECTION 3: PRICING AND DELIVERY SCHEDULE.....	17
1 PRICING AND DELIVERY SCHEDULE.....	17
2 SERVICE LEVELS.....	19
3 RISK.....	20
4 REFERENCES.....	21
SECTION 4: QUOTATION FORM AND LIST OF RETURNABLE DOCUMENTS.....	22
SECTION 5: RFQ DECLARATION AND BYEACT OF LAW FORM.....	27
SECTION 6: RFQ CLARIFICATION REQUEST FORM.....	29
SECTION 7: B-BBEE PREFERENCE POINTS CLAIM FORM.....	30
SECTION 8: CERTIFICATE OF ATTENDANCE OF RFQ BRIEFING.....	36
SECTION 9: SCHEDULE OF PLANT AND EQUIPMENT.....	37
SECTION 10: CLAUSE BY CLAUSE COMPLIANCE TO PROJECT SPECIFICATION.....	38
RFQ ANNEXURES	
SPECIFICATIONS, DRAWINGS AND STANDARDS	
ANNEXURE 1-BBF7820-POWER DISTRIBUTION CUBICLES FOR SIGNAL INSTALLATIONS	
ANNEXURE 2-BBG1027-VALVE REGULATED LEAD ACID BATTERIES FOR USE IN SIGNAL INSTALLATIONS	
ANNEXURE 3-BBG1023, BBG1499, BBG1500, BBG1501, BBG1502- DRAWINGS OF BATTERY STANDS	
ANNEXURE 4- KDS SCHEMATIC MAP AND KDS_PDC (SHT 1-6) DRAWINGS OF POWER DISTRIBUTION CUBICLE	

RFQ FOR KOEDOESPOORT DEPOT (SIGNALS) REPLACE SIGNAL POWER EQUIPMENT

Section 1: NOTICE TO BIDDERS

1 INVITATION TO BID

Responses to this RFQ [hereinafter referred to as a **Bid** or a **Quotation**] are requested from persons, companies, close corporations or enterprises [hereinafter referred to as an **entity, Respondent** or **Bidder**].

DESCRIPTION	For Koedoespoort depot (signals) replace signal power equipment [the Services]
	This RFQ is issued free of charge.
INSPECT / COLLECT DOCUMENTS FROM	The office of the Transnet Freight Rail Advice Centre Inyanda House 1 Ground Floor 21 Wellington road Parktown Johannesburg
ISSUE DATE AND COLLECTION DATE DEADLINE	Between 09:00 and 15:00 from 14 July 2015 until 20 July 2015
COMPULSORY/NON COMPULSORY BRIEFING SESSION	Yes Refer to paragraph 2 for details.
CLOSING DATE	10:00 on Tuesday 28 July 2015 Bidders must ensure that bids are delivered timeously to the correct address. As a general rule, if a bid is late or delivered to the incorrect address, it will not be accepted for consideration.
VALIDITY PERIOD	30 OCTOBER 2015 Bidders are to note that they may be requested to extend the validity period of their bid, at the same terms and conditions, if the internal evaluation process has not been finalised within the validity period.

Any additional information or clarification will be faxed or emailed to all Respondents, if necessary.

2 FORMAL BRIEFING

A compulsory pre-quotation RFQ briefing will be conducted at Transnet Freight Rail; at 10h00 on the 21 July 2015, Signal Relay Room, Bon Accord Station, on the side of R101 Hammanskraal road.

[Respondents to provide own transportation and accommodation]. The briefing session will start punctually and information will not be repeated for the benefit of Respondents arriving late.

- 2.1 *A Certificate of Attendance in the form set out in **Section 8** hereto must be completed and submitted with your Quotation as proof of attendance.*
- 2.2 Respondents failing to attend the compulsory RFQ briefing will be disqualified.

- 2.3 Respondents without a valid RFQ document but their company names appear on the tender collection list will be allowed to attend the meeting and it is entirely depended on them to obtain a valid RFQ document.

3 QUOTATION SUBMISSION

Quotations must be submitted in a sealed envelope addressed as follows:

The Secretariat, Transnet Acquisition Council
 RFQ No: **ERACES3184-18329**
 Descriptions Koedoespoort Depot (Signals) replace signal power equipment

Closing date and time: **28 July 2015**
 Closing address *[Refer to options in paragraph 4 below]*

All envelopes must reflect the return address of the Respondent on the reverse side.

4 DELIVERY INSTRUCTIONS FOR RFQ

4.1 Delivery by hand

If delivered by hand, the envelope is must be deposited in the Transnet tender box which is located in the foyer on the ground floor, Inyanda House 1, 21 Wellington road, Parktown, Johannesburg, and must be addressed as follows:

THE SECRETARIAT
 TRANSNET ACQUISITION COUNCIL
 GROUND FLOOR
 TENDER BOX
 INYANDA HOUSE 1
 21 WELLINGTON ROAD
 PARKTOWN
 JOHANNESBURG
 2001

- a) The measurements of the "tender slot" are 500mm wide x 100mm high, and Respondents must please ensure that response documents or files are no larger than the above dimensions. Responses which are too bulky [i.e. more than 100mm thick] must be split into two or more files, and placed in separate envelopes, each such envelope to be addressed as required in paragraph 3 above.
- b) It should also be noted that the above tender box is located at the main entrance and is accessible to the public 24 hours a day, 7 days a week.

4.2 Dispatch by courier

If dispatched by courier, the envelope must be addressed as follows and delivered to the Office of The Secretariat, Transnet Acquisition Council and a signature obtained from that Office:

THE SECRETARIAT
 TRANSNET ACQUISITION COUNCIL
 INYANDA HOUSE 1
 21 WELLINGTON ROAD
 PARKTOWN
 JOHANNESBURG

2001

- 4.3 If responses are not delivered as stipulated herein, such responses will not be considered.
- 4.4 No email or faxed responses will be considered, unless otherwise stated herein.
- 4.5 The responses to this RFQ will be opened as soon as possible after the closing date and time. Transnet shall not, at the opening of responses, disclose to any other company any confidential details pertaining to the Quotations / information received, i.e. pricing, delivery, etc. The names and locations of the Respondents will be divulged to other Respondents upon request.
- 4.6 Envelopes must not contain documents relating to any RFQ other than that shown on the envelope.

5 BROAD-BASED BLACK ECONOMIC EMPOWERMENT AND SOCIO-ECONOMIC OBLIGATIONS

As described in more detail in the attached BBBEE Claim Form and as prescribed in terms of the Preferential Procurement Policy Framework Act (PPPFA), Act 5 of 2000 and its Regulations, Respondents are to note that Transnet will allow a "preference" to companies who provide a valid B-BBEE Verification Certificate.

The value of this bid is estimated to exceed R1 000 000 (all applicable taxes included); and therefore the 90/10 system shall be applicable.

Respondents are required to complete Section 7 [the B-BBEE Preference Point Claim Form] and submit it together with proof of their B-BBEE Status as stipulated in the Claim Form in order to obtain preference points for their B-BBEE status.

Note: Failure to submit a valid and original B-BBEE certificate or a certified copy thereof at the Closing Date of this RFQ will result in a score of zero being allocated for B-BBEE.

5.1 B-BBEE Joint Ventures or Consortia

Respondents who would wish to respond to this RFQ as a Joint Venture [JV] or consortium with B-BBEE entities, must state their intention to do so in their RFQ submission. Such Respondents must also submit a signed JV or consortium agreement between the parties clearly stating the percentage [%] split of business and the associated responsibilities of each party. If such a JV or consortium agreement is unavailable, the partners must submit confirmation in writing of their intention to enter into a JV or consortium agreement should they be awarded business by Transnet through this RFQ process. This written confirmation must clearly indicate the percentage [%] split of business and the responsibilities of each party. In such cases, award of business will only take place once a signed copy of a JV or consortium agreement is submitted to Transnet.

Respondents are to note the requirements for B-BBEE compliance of JVs or consortiums as required by Section 7 [the B-BBEE Preference Point Claim Form] and submit it together with proof of their B-BBEE Status as stipulated in the Claim Form in order to obtain preference points for their B-BBEE status.

Note: Failure to submit a valid and original B-BBEE certificate for the JV or a certified copy thereof at the Closing Date of this RFQ will result in a score of zero being allocated for B-BBEE.

5.2 Subcontracting

Transnet fully endorses Government's transformation and empowerment objectives and when contemplating subcontracting Respondents are requested to give preference to companies which are

Black Owned, Black Women Owned, Black Youth Owned, owned by Black People with Disabilities, EMEs and QSEs including any companies designated as B-BBEE Facilitators¹.

If contemplating subcontracting, please note that a Respondent will not be awarded points for B-BBEE if it is indicated in its Quotation that such Respondent intends subcontracting more than 25% [twenty-five percent] of the value of the contract to an entity/entities that do not qualify for at least the same points that the Respondent qualifies for, unless the intended sub-Respondent is an EME with the capability to execute the contract.

A person awarded a contract may not subcontract more than 25% [twenty-five percent] of the value of the contract to any other enterprise that does not have an equal or higher B-BBEE status level than the person concerned, unless the contract is subcontracted to an EME that has the capability and ability to execute the subcontract.

In terms of Section 7 of this RFQ [the B-BBEE Preference Point Claim Form] Respondents are required to indicate the percentage of the contract that will be sub-contracted as well as the B-BBEE status of the sub-Contractor/s.

6 COMMUNICATION

- 6.1 For specific queries relating to this RFQ, an RFQ Clarification Request Form should be submitted to **Edwin Senne** before **12:00, 3 days prior to closing date**, substantially in the form set out in Section 6 hereto. In the interest of fairness and transparency Transnet's response to such a query will then be made available to the other Respondents who have collected RFQ documents. For this purpose Transnet will communicate with Respondents using the contact details provided to the Secretariat on issue of the bid documentation to the Respondent. Kindly ensure that you provide the Secretariat with the **correct** contact details, as Transnet will not accept responsibility for being unable to contact a bidder who provided incorrect contact details.
- 6.2 After the closing date of the RFQ, a Respondent may only communicate with the Secretariat of the Transnet Acquisition Company, at telephone number 011 544 9486, email **prudence.nkabinde@transnet.net** on any matter relating to its RFQ Quotation.
- 6.3 Respondents are to note that changes to its submission will not be considered after the closing date. Respondents are warned that a Quotation will be liable to disqualification should any attempt be made by a Respondent either directly or indirectly to canvass any officer or employee of Transnet in respect of this RFQ between the closing date and the date of the award of the business. Furthermore, Respondents found to be in collusion with one another will be automatically disqualified and restricted from doing business with Transnet in the future.

7 CONFIDENTIALITY

- 7.1 All information related to this RFQ is to be treated with strict confidence. In this regard Respondents are required to certify that they have acquainted themselves with the Non-Disclosure Agreement. All information related to a subsequent contract, both during and after completion thereof, will be treated with strict confidence. Should the need however arise to divulge any information gleaned from

¹ The Minister of the Department of Trade and Industry has the power to designate certain Organs of State or Public Entities as B-BBEE Facilitators. For example, the South African National Military Veterans' Association (SANMVA) has been designated as a B-BBEE Facilitator. As such they will be treated as having rights of ownership held 100% by Black People, 40% by Black Women and 20% by Black designated groups.

provision of the Services , which is either directly or indirectly related to Transnet's business, written approval to divulge such information must be obtained from Transnet.

8 INSTRUCTIONS FOR COMPLETING THE RFQ

- 8.1 Quotations must be submitted in duplicate hard copies [1 original and 1 copy] and must be bound.
- 8.2 Sign one set of original documents [sign, stamp and date the bottom of each page]. This set will serve as the legal and binding copy. A duplicate set of documents is required. This second set must be a copy of the original signed Quotation.
- 8.3 Both sets of documents are to be submitted to the address specified in paragraph 4 above, and Bidders must ensure that the original and copies (where applicable) are identical in all respects as Transnet will not accept any liability for having disqualified a bidder for failing to provide a mandatory returnable document in either the original or the copy of the RFQ albeit that it was included in the other.
- 8.4 **All returnable documents tabled in the Quotation Form [Section 4] must be returned with your Quotation.**
- 8.5 Unless otherwise expressly stated, all Quotations furnished pursuant to this RFQ shall be deemed to be offers. Any exceptions to this statement must be clearly and specifically indicated.
- 8.6 Any additional conditions must be embodied in an accompanying letter. Subject only to clause 15 [Alterations made by the Respondent to Bid Prices] of the General Bid Conditions, alterations, additions or deletions must not be made by the Respondent to the actual RFQ documents.

9 COMPLIANCE

The successful Respondent [hereinafter referred to as the **Service Provider**] shall be in full and complete compliance with any and all applicable laws and regulations.

10 DISCLAIMERS

Respondents are hereby advised that Transnet is not committed to any course of action as a result of its issuance of this RFQ and/or its receipt of Quotations. In particular, please note that Transnet reserves the right to:

- 10.1 Modify the RFQ's services and request Respondents to re-bid on any such changes;
- 10.2 Reject any Quotation which does not conform to instructions and specifications which are detailed herein;
- 10.3 Disqualify Quotations submitted after the stated submission deadline [Closing Date];
- 10.4 Not necessarily accept the lowest priced Quotation or an alternative bid;
- 10.5 Reject all Quotations, if it so decides;
- 10.6 Withdraw the RFQ on good cause shown;
- 10.7 Award a contract in connection with this Quotation at any time after the RFQ's closing date;
- 10.8 Award a contract for only a portion of the proposed Services which are reflected in the scope of this RFQ;
- 10.9 Split the award of the contract between more than one Service Provider, should it at Transnet's discretion be more advantageous in terms of, amongst others, cost or developmental considerations;
- 10.10 Make no award of a contract;

10.11 Should a contract be awarded on the strength of information furnished by the Respondent, which after conclusion of the contract, is proved to have been incorrect, Transnet reserves the right to cancel the contract.

Transnet reserves the right to undertake post-tender negotiations [PTN] with selected Respondents or any number of short-listed Respondents, such PTN to include, at Transnet's option, any evaluation criteria listed in this RFQ document.

Transnet reserves the right to award the business to the highest scoring bidder/s unless objective criteria justify the award to another bidder.

Should the preferred bidder fail to sign or commence with the contract within a reasonable period after being requested to do so, Transnet reserves the right to award the business to the next ranked bidder, provided that he/she is still prepared to provide the required goods at the quoted price.

Transnet reserves the right to lower the threshold for Technical from 60% to 50% if no Bidders pass the predetermined minimum threshold in respect of Technical.

Kindly note that Transnet will not reimburse any Respondent for any preparatory costs or other work performed in connection with its Quotation, whether or not the Respondent is awarded a contract.

11 LEGAL REVIEW

A Quotation submitted by a Respondent will be subjected to review and acceptance or rejection of its proposed contractual terms and conditions by Transnet's Legal Counsel, prior to consideration for an award of business.

**Transnet urges its clients, suppliers and the general public
to report any fraud or corruption to
TLP-OFFS ANONYMOUS: 0800 003 056**

RFQ FOR KOEDOESPOORT DEPOT (SIGNALS) REPLACE SIGNAL POWER EQUIPMENT

Section 2: SCOPE OF REQUIREMENTS

1 SCOPE OF WORK

The scope of work required by Koedoespoort depot is to replace power equipment at various signal relay rooms as indicated in this RFQ.

1.1 SPECIFICATIONS, DRAWINGS AND STANDARDS

- 1.1.1 BBF7820 – Power distribution cubicles for signal installations.
- 1.1.2 BBG1027 – Valve regulated lead acid batteries for use in signal installations.
- 1.1.3 BBG1023, BBG1499, BBG1500, BBG1501, BBG1502 – Drawings of battery stands.
- 1.1.4 KDS_PDC (SHT 1 – 6) – Drawings of power distribution cubicle.

1.2 REQUIREMENTS

- 1.2.1 The Respondent shall submit a list of projects (Transnet) where the tenderer have been contracted to do similar work.
- 1.2.2 The Respondent and his personnel shall attend an induction training session and be in possession of a site access certificate issued by the depot engineer before any work may start. The replacement team shall have the certificates with them at all times when on site.

1.3 REPLACEMENT SCHEDULE

- 1.3.1 The power equipment shall be transported to site as indicated below.

STATION	DESCRIPTION OF EQUIPMENT TO REPLACE AND REMOVE
Wilbeesthoek	UPS 30kVA, Batteries (Set of 32 Blocks 170A/H with stands), Power distribution cubicle (1930 x 820 x 500). Existing power distribution cubicle, Charger, Inverter VLA batteries to be removed and disposed of as per environmental law.
Kameeldrift	UPS 30kVA, Batteries (Set of 32 Blocks 170A/H with stands), Power distribution cubicle (1930 x 820 x 500).

	Existing power distribution cubicle, Charger, Inverter VLA batteries to be removed and disposed of as per environmental law.
Baviaanspoort	UPS 30kVA, Batteries (Set of 32 Blocks 170A/H with stands), Power distribution cubicle (1930 x 820 x 500).
	Existing power distribution cubicle, Charger, Inverter VLA batteries to be removed and disposed of as per environmental law.
Leeufontein	UPS 30kVA, Batteries (Set of 32 Blocks 170A/H with stand), Power distribution cubicle (1930 x 820 x 500).
	Existing power distribution cubicle, Charger, Inverter VLA batteries to be removed and disposed of as per environmental law.
Bon Accord	Power distribution cubicle (1930 x 820 x 500), New transformers.
	Existing power distribution cubicle to be removed.

1.4 MATERIAL, LABOUR AND TRANSPORT TO BE SUPPLIED BY RESPONDENT

DESCRIPTION
POWER DISTRIBUTION CUBICLE AS PER DRAWING: KDS_PDC (TRANSNET APPROVED)
MP3030 UPS 400/400 - TRANSNET APPROVED
170 A/H 12V VRLA BATTERY "THIN PLATE PURE LEAD" FRONT TERMINAL 10 YEAR + DESIGN LIFE (FLOAT @ 25 DEG. C) - SET OF 32 WITH LINKS (31) TRANSNET APPROVED
STANDS (SET OF 32) AS PER ATTACHED DRAWINGS TRANSNET APPROVED
ELTEK FP2 POWER SHELVES WITH BRACKETS (268035 HC HV DC) TRANSNET APPROVED
ELTEK FP2 MODULAR 60VDC POWER SUPPLY (241115.705C) TRANSNET APPROVED
ELTEK SIMPLIFIED CONTROLLER (820763) WITH DIN RAIL BRACKET TRANSNET APPROVED
0 - 50vdc DATA LOGGER WITH SOFTWARE
FLUKE 365 CLAMP
PULS QS10.121 RECTIFIER 12V 10A
TRANSPORT 8 TON TRUCK WITH CRANE R/Km (ESTIMATE)
TRANSPORT LDV R/Km (ESTIMATE)
LABOUR ARTISAN R/Hour (ESTIMATE)
LABOUR UNSKILLED R/Hour (ESTIMATE)
ACCOMMODATION R/Night

1.4.1 Brochures of equipment must be submitted for Transnet Approved verification.

1.4.2 All material required not specified in table 1.4 will be supplied by Transnet.

1.5 MATERIAL TO BE REMOVED FROM SITE

1.5.1 Obsolete chargers and inverters shall be removed from sites and transported to Germiston stores to be scrapped.

1.5.2 All VLA batteries shall be removed and disposed of as per environmental law. (Proof of disposal process shall be submitted)

1.5.3 The existing power distribution cubicles shall be transported to Johannesburg and stripped for re-use by TFR.

1.6 SAFETY REQUIREMENTS (HEALTH, RISK AND SAFETY PLAN)

1.6.1 The Respondent shall submit a safety, health and environment plan incorporating the following elements:

1.6.1.1 Scope of work

1.6.1.2 Roles and responsibilities of Respondent personnel.

1.6.1.3 Hazard Management plan.

1.6.1.4 Contract induction and safety training.

1.6.1.5 Safe work practices and procedures.

1.6.1.6 Emergency procedures.

1.6.1.7 Incident recording and investigation.

1.6.1.8 Health and safety performance monitoring.

1.6.1.9 Dangerous goods/Hazardous substances.

1.6.1.10 Management of sub-Contractors (Where applicable)

1.7 COMPLETION OF WORK

Work shall be completed within 5 months from date of order.

1.8 COMPLIANCE TO SPECIFICATION

The tenderer shall submit a clause by clause statement of compliance to this specification.

CONTACT PERSON FOR TECHNICAL ENQUIRIES

Mr. Poppie Legodi / Mr Pieter Doorewaard

Telephone (012 842 5310) or 083 283 3885

2 GREEN ECONOMY / CARBON FOOTPRINT

Transnet wishes to have an understanding of your company's position with regard to environmental commitments, including key environmental characteristics such as waste disposal, recycling and energy conservation. *Please submit details of your entity's policies in this regard.*

3 GENERAL SERVICE PROVIDER OBLIGATIONS

3.1 The Service Provider(s) shall be fully responsible to Transnet for the acts and omissions of persons directly or indirectly employed by them.

3.2 The Service Provider(s) must comply with the requirements stated in this RFQ.

"PREVIEW COPY ONLY"

4 EVALUATION METHODOLOGY

Transnet will utilise the following methodology and criteria in selecting a preferred Service Provider, if so required:

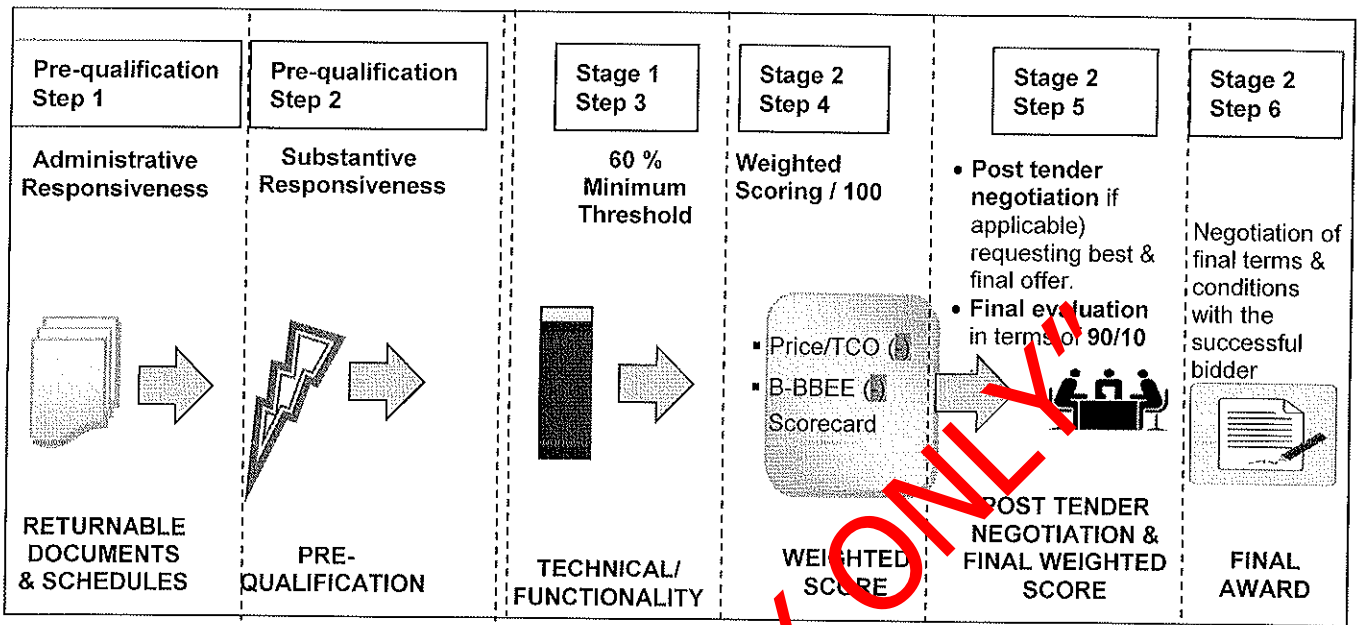

NB: Evaluation of the various stages will normally take place in a sequential manner. However, in order to expedite the process, Transnet reserves the right to conduct the different stages of the evaluation process in parallel. In such instances the evaluation of bidders at any given stage must therefore not be interpreted to mean that bidders have necessarily passed any previous stage(s).

4.1 PRE-QUALIFICATION STAGE ~ STEP ONE: Test for Administrative Responsiveness

The test for administrative responsiveness will include the following:

Administrative responsiveness check	RFQ Reference
<ul style="list-style-type: none"> Whether the Bid has been lodged on time 	<i>Section 1 paragraph 3</i>
<ul style="list-style-type: none"> Whether all mandatory returnable documents and/or schedules [where applicable] were completed and returned by the closing date and time Valid letter of good standing issued by department of labour (essential returnable document) 	<i>Section 4</i>
<ul style="list-style-type: none"> Verify the validity of all returnable documents 	<i>Section 4, page 24 and 25</i>

The test for administrative responsiveness must be passed for a Respondent's Quotation to progress to the next stage for further pre-qualification

4.2 PRE-QUALIFICATION STAGE ~ STEP TWO: Test for Substantive Responsiveness to RFQ

The test for substantive responsiveness to this RFQ will include the following:

Check for substantive responsiveness	RFQ Reference
<ul style="list-style-type: none"> Whether any general pre-qualification criteria set by Transnet, have been met 	<i>Section 4</i>
<ul style="list-style-type: none"> Whether the Bid contains a priced offer 	<i>Section 3</i>
<ul style="list-style-type: none"> Whether the Bid materially complies with the scope and/or specification given <p>~ A fully completed clause by clause statement of compliance to project specification (Please complete section 10 in full available on page (38 to 39))</p>	<i>All Sections</i>
<ul style="list-style-type: none"> Whether the compulsory information briefing session was attended 	<i>Section 1, paragraphs 2.1 & section 8</i>

The test for substantive responsiveness must be passed for a Respondent's Quotation to progress to the next stage for further evaluation

4.3 STAGE 1 ~ STEP 3: Minimum Threshold 60% for Technical Criteria

The test for the Technical and Functional threshold will include the following:

Technical Criteria	% Weightings	RFQ Reference
<ul style="list-style-type: none"> Experience 	30%	<i>Section 2 page 21</i>
<ul style="list-style-type: none"> Statement of compliance to project specification 	30%	<i>Section 2 page 9-11 & Section 10 page 38 & 39</i>
<ul style="list-style-type: none"> Health, risk and safety plan 	20%	<i>Section 2 page 11</i>
<ul style="list-style-type: none"> Delivery period (time frame of 5 months) 	20%	<i>Section 3 page 18</i>
Total Weighting:	100%	
Minimum qualifying score required:	60	

The following applicable values will be utilised when scoring each criterion mentioned above:

Points	Interpretation
0	Non Responsive
50	Good
100	Excellent

The minimum threshold for technical/functionality [Stage One] must be met or exceeded for a Respondent's Quotation to progress to Stage Two for final evaluation

4.4 STAGE TWO ~ STEP 4: Evaluation and Final Weighted Scoring

a) **Price Criteria** [Weighted score **90** points]:

Evaluation Criteria	RFQ Reference
• Commercial offer	Section 3

Transnet will utilise the following formula in its evaluation of Price:

$$PS = 90 \left(1 - \frac{Pt - Pmin}{Pmin} \right)$$

Where:

Ps = Score for the Bid under consideration

Pt = Price of Bid under consideration

$Pmin$ = Price of lowest acceptable Bid

b) **Black-Based Black Economic Empowerment criteria** [Weighted score **10** points]

B-BBEE - current scorecard / B-BBEE Preference Points Claims Form

- Preference points will be awarded to a bidder for attaining the B-BBEE status level of contribution in accordance with the table indicated in Section 4.1 of the B-BBEE Preference Points Claim Form.

4.5 SUMMARY: Applicable Thresholds and Final Evaluated Weightings

Thresholds	Minimum Percentage [%]
Technical / functionality	60

Evaluation Criteria	Final Weighted Scores
Price	90
B-BBEE - Scorecard	10
TOTAL SCORE:	100

5 STAGE TWO ~ STEP 5: Post Tender Negotiations (if applicable)

Transnet reserves the right to conduct post tender negotiations with a shortlist of Respondent(s). The shortlist could comprise of one or more Respondents. Should Transnet conduct post tender negotiations, Respondents will be requested to provide their best and final offers to Transnet based on such negotiations. A final evaluation will be conducted in terms of **90/10**.

6 STAGE TWO ~ STEP 6: Final Contract Award

Transnet will negotiate the final terms and condition the contract with the successful Respondent(s). This may include aspects such as Supplier Development, the B-BBEE Improvement Plan, price and delivery. Thereafter the final contract will be awarded to the successful Respondent(s)

IMPORTANT NOTICE TO RESPONDENTS

Transnet has appointed a Procurement Ombudsman to investigate any material complaint in respect of RFQs exceeding R5million [five million S.A. Rand] in value. Should a Respondent have any material concern regarding an RFQ process which meets this threshold, a complaint may be lodged with the Ombudsman for further investigation. The Ombudsman reserves the right to refer the complaint to an external service provider for investigation.

It is incumbent on the Respondent to familiarise himself/herself with the Terms of Reference OF the Ombudsman which are available for review at Transnet's website www.transnet.net.

An official complaint form may be downloaded from this website and submitted, together with any supporting documentation, within the prescribed period, to procurement.ombud@transnet.net.

For transactions below the abovementioned threshold, a complaint may be lodged with the Chief Procurement Officer of the relevant Transnet Operating Division/Specialist Unit.

Respondents are to note that a complaint must be made in good faith. If a complaint is made in bad faith, Transnet reserves the right to place such a Bidder on its List of Excluded Bidders.

"PREVIEW COPY ONLY"

RFQ FOR KOEDOESPOORT DEPOT (SIGNALS) REPLACE SIGNAL POWER EQUIPMENT**CLOSING VENUE:** As per Section 1, paragraph 4.1**CLOSING DATE:** 28 July 2015**CLOSING TIME:** 10h00**VALIDITY PERIOD:** 30 OCTOBER 2015**Section 3: PRICING AND DELIVERY SCHEDULE***Respondents are required to complete the table below:*

SCHEDULE OF WORK AND PRICES					
ITEM NO	DESCRIPTION	QUANTITY	UNIT	PRICE PER UNIT	TOTAL PRICE AMOUNT
1	POWER DISTRIBUTION CUBICLE AS PER DRAWING: KDS_PDC (TRANSNET APPROVED)	5	ea.		
2	MP3030 UPS 400/400 - TRANSNET APPROVED	4	ea.		
3	170 A/H 12V VRLA BATTERY "THIN PLATE PURE LEAD" FRONT TERMINAL 10 YEAR + DESIGN LIFE (FLOAT @ 25 DEG. C) - SET OF 32 WITH LINKS (31)TRANSNET APPROVED	4	ea.		
4	STANDS (SET OF 4) AS PER ATTACHED DRAWINGS TRANSNET APPROVED	4	ca.		
5	ELTEK FP2 POWER SHELVES WITH BRACKETS (268035 HC) 60VDC TRANSNET APPROVED	6	ea.		
6	ELTEK FP2 MODULAR 60VDC POWER SUPPLY (241115.705C)TRANSNET APPROVED	24	ea.		
7	ELTEK SIMPLIFIED CONTROLLER (820763) WITH DIN RAIL BRACKET TRANSNET APPROVED	6	ea.		
8	0-50vdc DATA LOGGER WITH SOFTWARE	5	ea.		
9	FLUKE 365 CLAMP	2	ea.		

Respondent's Signature

Date & Company Stamp

10	PULS QS10.121 RECTIFIER 12V 10A	14	ea.		
11	TRANSPORT 8 TON TRUCK WITH CRANE R/Km (ESTIMATE)	1500	Km		
12	TRANSPORT LDV R/Km (ESTIMATE)	1500	Km		
13	LABOUR ARTISAN R/Hour (ESTIMATE)	100	Rate per hour		
14	LABOUR UNSKILLED R/Hour (ESTIMATE)	150	Rate per hour		
15	ACCOMMODATION R/Night	5	Rate per night		
				SUB TOTAL	
				VAT @14%	
				GROSS TOTAL AMOUNT (INCLUSIVE)	

PLEASE INDICATE DELIVERY PERIOD (TIMEFRAME) BELOW:

LEAD TIME FROM THE DATE OF PURCHASE ORDER: _____
[months]

"PREVIEW COPY ONLY"

Respondent's Signature

Date & Company Stamp

Notes to Pricing:

- a) Prices must be quoted in South African Rand, exclusive of VAT
- b) To facilitate like-for-like comparison bidders must submit pricing strictly in accordance with this pricing schedule and not utilise a different format. Deviation from this pricing schedule could result in a bid being declared non-responsive.
- c) Please note that should you have offered a discounted price(s), Transnet will only consider such price discount(s) in the final evaluation stage if offered on an unconditional basis.
- d) Respondents, if awarded the contract, are required to indicate that their prices quoted would be kept firm and fixed for the contract duration. [Not to be confused with bid validity period Section 1, clause 1]

YES	
-----	--

1 DISCLOSURE OF PRICES TENDERED

1.1 Respondents must indicate below whether Transnet may disclose their tendered prices and conditions to other Respondents:

YES	
-----	--

NO	
----	--

2 SERVICE LEVELS

- 2.1 An experienced account representative(s) is required to work with Transnet's procurement department. [No sales representatives are needed for individual department or locations]. Additionally, there shall be a minimal number of people, fully informed and accountable for this agreement.
- 2.2 Transnet will have quarterly reviews with the Service provider's account representative on an ongoing basis.
- 2.3 Transnet reserves the right to request that any member of the Service provider's team involved on the Transnet account be replaced if deemed not to be adding value for Transnet.
- 2.4 The service provider guarantees that it will achieve a 95% [ninety-five per cent] service level on the following measures:
 - a) Random checks on compliance with quality/quantity/specifications
 - b) On-time delivery
- 2.5 The Service provider must provide a telephone number for customer service calls.
- 2.6 Failure of the Service provider to comply with stated service level requirements will give Transnet the right to cancel the contract in whole, without penalty to Transnet; giving 30 [thirty] calendar days' notice to the Service provider of its intention to do so.

Respondent's Signature

Date & Company Stamp

Acceptance of Service Levels:

YES	
------------	--

NO	
-----------	--

3 RISK

Respondents must elaborate on the control measures put in place by their entity, which would mitigate the risk to Transnet pertaining to potential non-performance by a Service provider, in relation to:

3.1 Quality and specification of Services delivered:

3.2 Continuity of supply:

3.3 Compliance with the Occupational Health and Safety Act, 85 of 1993:

"PREVIEW COPY ONLY"

Respondent's Signature

Date & Company Stamp

RFQ FOR KOEDOESPOORT DEPOT (SIGNALS) REPLACE SIGNAL POWER EQUIPMENT

Section 4: QUOTATION FORM AND LIST OF RETURNABLE DOCUMENTS

I/We _____
[name of entity, company, close corporation or partnership] of [full address]

_____ carrying on business trading/operating as _____

represented by _____

in my capacity as _____

being duly authorised thereto by a Resolution of the Board of Directors or Members or Certificate of Partners, dated _____ to enter into, sign execute and complete any documents relating to this Quotation and any subsequent Agreement. The following list of persons are hereby authorised to negotiate on behalf of the abovementioned entity, should Transnet decide to enter into Post Tender negotiations with shortlisted bidder(s).

FULL NAME(S)	CAPACITY	SIGNATURE
_____	_____	_____
_____	_____	_____
_____	_____	_____
_____	_____	_____

I/We hereby offer to supply the abovementioned Services at the prices quoted in the schedule of prices in accordance with the terms set forth in the documents listed in the accompanying schedule of RFQ documents.

I/We agree to be bound by those conditions in Transnet's:

- (i) Master Agreement;
- (ii) General Bid Conditions – Services; and
- (iii) any other standard or special conditions mentioned and/or embodied in this Request for Quotation.

I/We accept that unless Transnet should otherwise decide and so inform me/us in the letter of award/intent, this Quotation [and, if any, its covering letter and any subsequent exchange of correspondence], together with Transnet's acceptance thereof shall constitute a binding contract between Transnet and me/us.

Should Transnet decide that a formal contract should be signed and so inform me/us in a letter of intent [the **Letter of Intent**], this Quotation [and, if any, its covering letter and any subsequent exchange of

Respondent's Signature

Date & Company Stamp

correspondence] together with Transnet's Letter of Intent, shall constitute a binding contract between Transnet and me/us until the formal contract is signed.

I/We further agree that if, after I/we have been notified of the acceptance of my/our Quotation, I/we fail to enter into a formal contract if called upon to do so, or fail to commence the supply of Services within 4 [four] weeks thereafter, Transnet may, without prejudice to any other legal remedy which it may have, recover from me/us any expense to which it may have been put in calling for Quotations afresh and/or having to accept any less favourable Quotation.

I/We accept that any contract resulting from this offer will be for a period of **5 months only**.

Furthermore, I/we agree to a penalty clause/s to be negotiated with Transnet, which will allow Transnet to invoke a penalty against us for non-compliance with material terms of this RFQ including the delayed delivery of the Services due to non-performance by ourselves, failure to meet Supplier Development and/or B-BBEE Improvement Plan commitments. A penalty of up to 100% of the outstanding portion of the Supplier Development commitment will be applied and Transnet reserves the right to set this off against any payment due to the Respondent. In addition, I/we agree that non-compliance with any of the material terms of this RFQ, including those mentioned above, will constitute a material breach of contract and provide Transnet with cause for cancellation.

ADDRESS FOR NOTICES

The law of the Republic of South Africa shall govern any contract created by the acceptance of this RFQ. The *domicilium citandi et executandi* shall be a place in the Republic of South Africa to be specified by the Respondent hereunder, at which all legal documents may be served on the Respondent who shall agree to submit to the jurisdiction of the courts of the Republic of South Africa. Foreign Respondents shall, therefore, state hereunder the name of their authorised representative in the Republic of South Africa who has the power of attorney to sign any contract which may have to be entered into in the event of their Quotation being accepted and to act on their behalf in all matters relating to such contract.

Respondent to indicate the details of its *domicilium citandi et executandi* hereunder:

Name of Entity:

Facsimile

Address:

NOTIFICATION OF AWARD OF RFQ

As soon as possible after approval to award the contract(s), the successful Respondent [the Service provider] will be informed of the acceptance of its Quotation. Unsuccessful Respondents will be advised in writing of the name of the successful Service provider and the reason as to why their Quotations have been unsuccessful, for example, in the category of price, delivery period, quality, B-BBEE status or for any other reason.

VALIDITY PERIOD

Transnet requires a validity period up to **30 OCTOBER 2015** against this RFQ.

Respondent's Signature

Date & Company Stamp

NAME(S) AND ADDRESS / ADDRESSES OF DIRECTOR(S) OR MEMBER(S)

The Respondent must disclose hereunder the full name(s) and address(s) of the director(s) or members of the company or close corporation [C.C.] on whose behalf the RFQ is submitted.

(i) Registration number of company / C.C. _____

(ii) Registered name of company / C.C. _____

(iii) Full name(s) of director/member(s)	Address/Addresses	ID Number(s)

RETURNABLE DOCUMENTS

All Sections, as indicated in the footer of each page, must be signed, stamped and dated by the Respondent.

Returnable Documents means all the documents, Sections and Annexures, as listed in the tables below.

a) Mandatory Returnable Documents

Failure to provide all Mandatory Returnable Documents at the closing date and time of this tender will result in a Respondent's disqualification. Bidders are therefore urged to ensure that all these documents are returned with their Quotations.

Please confirm submission of the **mandatory Returnable Documents** detailed below by so indicating [Yes or No] in the table below:

MANDATORY RETURNABLE DOCUMENTS	SUBMITTED [Yes/No]
SECTION 3 : Pricing and Delivery Schedule	
SECTION 8 : Certificate of attendance of compulsory RFQ Briefing session	
SECTION 10: Clause by clause statement of compliance to project specification	

b) Essential Returnable Documents

In addition to the requirements of section (a) above, Respondents are further required to submit with their Quotations the following **essential Returnable Documents** as detailed below.

Failure to provide all essential Returnable Documents may result in a Respondent's disqualification at Transnet's sole discretion. Bidders are therefore urged to ensure that all these documents are returned with their Quotations.

Please confirm submission of these essential Returnable Documents by so indicating [Yes or No] in the table below:

Respondent's Signature

Date & Company Stamp

ESSENTIAL RETURNABLE DOCUMENTS & SCHEDULES	SUBMITTED [Yes or No]
SECTION 4 : Quotation Form and List of Returnable documents	
- Valid and original, or a certified copy, of your entity's B-BBEE Accreditation Certification as per the requirements stipulated in the B-BBEE Claims Form Section 7. Note: failure to provide these required documents at the closing date and time of the RFQ will result in an automatic score of zero being allocated for preference	
- In the case of Joint Ventures, a copy of the Joint Venture Agreement or written confirmation of the intention to enter into a Joint Venture Agreement	
- Latest Financial Statements signed by your Accounting Officer or latest Audited Financial Statements plus 2 previous years	
Original and valid Tax Clearance Certificate [Consortia / Joint Ventures must submit a separate Tax Clearance Certificate for each party]	
SECTION 5 : RFQ Declaration and Breach of Law Form	
SECTION 7 : B-BBEE Preference Claim Form	
SECTION 9 : Schedule of Plant and Equipment	
A valid letter of good standing with the Compensation Commissioner issued by the Department of Labour	

c) Additional Documents

In addition to the requirements of paragraphs (a) and (b) above, Respondents are further requested to submit with their Quotations the following **additional documents** as detailed below. Please confirm submission of these additional documents by so indicating [Yes or No] in the table below:

ADDITIONAL DOCUMENTS	SUBMITTED [Yes or No]
Brochures of equipment must be submitted for Transport Approved verification	

CONTINUED VALIDITY OF RETURNABLE DOCUMENTS

The successful Respondent will be required to ensure the validity of all returnable documents, including but not limited to its Tax Clearance Certificate and valid B-BBEE Verification Certificate, for the duration of any contract emanating from this RFQ. Should the Respondent be awarded the contract **[the Agreement]** and fail to present Transnet with such renewals as and when they become due, Transnet shall be entitled, in addition to any other rights and remedies that it may have in terms of the eventual Agreement, to terminate such Agreement forthwith without any liability and without prejudice to any claims which Transnet may have for damages against the Respondent.

By signing this certificate the Respondent is deemed to acknowledge that he/she has made himself/herself thoroughly familiar with, and agrees with all the conditions governing this RFQ, including those contained in any printed form stated to form part hereof, including but not limited to the documents stated below and Transnet SOC Ltd will recognise no claim for relief based on an allegation that the Respondent overlooked any such condition or failed properly to take it into account for the purpose of calculating tendered prices or otherwise.

Respondent's Signature

Date & Company Stamp

Bidders furthermore agree that Transnet SOC Ltd shall recognise no claim from them for relief based on an allegation that they have overlooked any RFQ/contract condition or failed to take it into account for the purpose of calculating their offered prices or otherwise.

Bidders accept that an obligation rests on them to clarify any uncertainties regarding any bid which they intend to respond on, before submitting the bid. The Bidder agrees that he/she will have no claim based on an allegation that any aspect of this RFQ was unclear but in respect of which he/she failed to obtain clarity.

The bidder understands that his/her Bid will be disqualified if the Certificate of Acquaintance with RFQ documents included in the RFQ as a returnable document, is found not to be true and complete in every respect.

- 1 General Bid Conditions*
- 2 Master Agreement*
- 3 Supplier Integrity Pact*
- 4 Non-disclosure Agreement*
- 5 Specifications and drawings included in this RFQ
- 6 Vendor Application Form* and all supporting documents (first time vendors only)
- 7 E4E – Safety arrangements and Procedural compliance (Act 85 of 1993) and applicable regulations*
- 8 BBD8210 version 1 – E/7 – Specification to general work and works on, over, under or adjacent to railway lines and near high voltage equipment*

Alternatively, for all existing vendors, please provide vendor number(s) here:

Transnet Operating Division	Unique Vendor Number	Yes / No
Transnet Group		
TFR, etc.		

In the Yes/No column above, please confirm that all the information e.g. company address and contact details, banking details etc are still correct as at the time of allocation of the vendor number(s).

*(available on Transnet's website or upon request)

SIGNED at _____ on this _____ day of _____ 20____

SIGNATURE OF WITNESSES

ADDRESS OF WITNESSES

1 _____
Name _____

2 _____
Name _____

SIGNATURE OF RESPONDENT'S AUTHORISED REPRESENTATIVE: _____

NAME: _____

TELEPHONE: _____

DESIGNATION: _____

CELL PHONE: _____

FACSIMILE: _____

Respondent's Signature

Date & Company Stamp

RFQ FOR KOEDOESPOORT DEPOT (SIGNALS) REPLACE SIGNAL POWER EQUIPMENT

Section 5: RFQ DECLARATION AND BREACH OF LAW FORM

NAME OF ENTITY: _____

We _____ do hereby certify that:

1. Transnet has supplied and we have received appropriate responses to any/all questions [as applicable] which were submitted by ourselves for RFQ Clarification purposes;
2. we have received all information we deemed necessary for the completion of this Request for Quotation [RFQ];
3. we have been provided with sufficient access to the existing Transnet facilities/sites and any and all relevant information relevant to the Services as well as Transnet information and Employees, and has had sufficient time in which to conduct and perform a thorough due diligence of Transnet's operations and business requirements and assets used by Transnet. Transnet will therefore not consider or permit any pre- or post-contract verification or any related adjustment to pricing, service levels or any other provision/conditions based on any incorrect assumptions made by the Respondent in arriving at his Bid Price.
4. at no stage have we received additional information relating to the subject matter of this RFQ from Transnet sources, other than information formally received from the designated Transnet contact(s) as nominated in the RFQ documents;
5. we are satisfied, insofar as our entity is concerned, that the processes and procedures adopted by Transnet in issuing this RFQ and the requirements requested from Bidders in responding to this RFQ have been conducted in a fair and transparent manner; and
6. furthermore, we declare that a family, business and/or social relationship **exists / does not exist** [delete as applicable] between an owner / member / director / partner / shareholder of our entity and an employee or board member of the Transnet Group including any person who may be involved in the evaluation and/or adjudication of this Bid.
7. In addition, we declare that an owner / member / director / partner / shareholder of our entity **is / is not** [delete as applicable] an employee or board member of the Transnet Group.
8. If such a relationship as indicated in paragraph 6 and/or 7 exists, the Respondent is to complete the following section:

FULL NAME OF OWNER/MEMBER/DIRECTOR/
PARTNER/SHAREHOLDER:

ADDRESS:

Indicate nature of relationship with Transnet:

[Failure to furnish complete and accurate information in this regard will lead to the disqualification of a response and may preclude a Respondent from doing future business with Transnet]

9. We declare, to the extent that we are aware or become aware of any relationship between ourselves and Transnet [other than any existing and appropriate business relationship with Transnet] which could unfairly advantage our entity in the forthcoming adjudication process, we shall notify Transnet immediately in writing of such circumstances.
10. We accept that any dispute pertaining to this Bid will be resolved through the Ombudsman process and will be subject to the Terms of Reference of the Ombudsman. The Ombudsman process must first be exhausted before judicial review of a decision is sought.
11. We further accept that Transnet reserves the right to reverse an award of business or decision based on the recommendations of the Ombudsman without having to follow a formal court process to have such award or decision set aside.

BREACH OF LAW

12. We further hereby certify that I/we (the bidding entity and/or any of its directors, members or partners) **have/have not been** [delete as applicable] found guilty during the preceding 5 [five] years of a serious breach of law, including but not limited to a breach of the Competition Act, 89 of 1998, by a court of law, tribunal or other administrative body. The type of breach that the Respondent is required to disclose excludes relatively minor offences or misdemeanours, e.g. traffic offences. This includes the imposition of an administrative fine or penalty.

Where found guilty of such a serious breach, please disclose:

NATURE OF BREACH:

DATE OF BREACH: _____

Furthermore, I/we acknowledge that Transnet SOC Ltd reserves the right to exclude any Respondent from the bidding process, should that person or entity have been found guilty of a serious breach of law, tribunal or regulatory obligation.

SIGNED at _____ on this _____ day of _____ 20____

For and on behalf of _____	AS WITNESS:
duly authorised hereto	
Name:	Name:
Position:	Position:
Signature:	Signature:
Date:	Registration No of Company/CC
Place:	Registration Name of Company/CC

RFQ FOR KOEDOESPOORT DEPOT (SIGNALS) REPLACE SIGNAL POWER EQUIPMENT

Section 6: RFQ CLARIFICATION REQUEST FORM

RFQ No: **ERACES3184-18329**

RFQ deadline for questions / RFQ Clarifications: Before 12:00, 3 days prior to closing date

TO: Transnet SOC Ltd
ATTENTION: Edwin Senne
EMAIL: edwin.senne@transnet.net
DATE: _____
FROM: _____

RFQ Clarification No **ERACES3184-18329**

REQUEST FOR RFQ CLARIFICATION

"PREVIEW COPY ONLY"

RFQ FOR KOEDOESPOORT DEPOT (SIGNALS) REPLACE SIGNAL POWER EQUIPMENT

Section 7: B-BBEE PREFERENCE POINTS CLAIM FORM

This preference form contains general information and serves as a claim for preference points for Broad-Based Black Economic Empowerment [B-BBEE] Status Level of Contribution.

1. INTRODUCTION

- 1.1 A total of **10** preference points shall be awarded for B-BBEE Status Level of Contribution.
- 1.2 Failure on the part of a Bidder to fill in and/or to sign this form and submit a B-BBEE Verification Certificate from a Verification Agency accredited by the South African Accreditation System [SANAS] or a Registered Auditor approved by the Independent Regulatory Board of Auditors [IRBA] or an Accounting Officer as contemplated in the Close Corporation Act [CCA] together with the bid will be interpreted to mean that preference points for B-BBEE Status Level of Contribution are not claimed.
- 1.3 Transnet reserves the right to require of a Bidder, either before a Bid is adjudicated or at any time subsequently, to substantiate any claim in regard to preferences, in any manner required by Transnet.

2. GENERAL DEFINITIONS

- 2.1 "**all applicable taxes**" include value added tax, pay as you earn, income tax, unemployment insurance fund contributions and skills development levies;
- 2.2 "**B-BBEE**" means broad-based black economic empowerment as defined in section 1 of the Broad-Based Black Economic Empowerment Act;
- 2.3 "**B-BBEE status of contributor**" means the B-BBEE status received by a measured entity based on its overall performance using the relevant scorecard contained in the Codes of Good Practice on Black Economic Empowerment, issued in terms of section 9(1) of the Broad-Based Black Economic Empowerment Act;
- 2.4 "**bid**" means a written offer in a prescribed or stipulated form in response to an invitation by Transnet for the provision of goods, works or services;
- 2.5 "**Broad-Based Black Economic Empowerment Act**" means the Broad-Based Black Economic Empowerment Act, 2003 [Act No. 53 of 2003];
- 2.6 "**comparative price**" means the price after the factors of a non-firm price and all unconditional discounts that can be utilised have been taken into consideration;
- 2.7 "**consortium or joint venture**" means an association of persons for the purpose of combining their expertise, property, capital, efforts, skills and knowledge in an activity for the execution of a contract;
- 2.8 "**contract**" means the agreement that results from the acceptance of a bid by Transnet;
- 2.9 "**EME**" means any enterprise with an annual total revenue of R5 [five] million or less as per the 2007 version of the B-BBEE Codes of Good Practice and means any enterprise with an annual total revenue of R10 [ten] million or less as per the Revised Codes of Good Practice issued on 11 October 2013 in terms of Government Gazette No. 36928;
- 2.10 "**firm price**" means the price that is only subject to adjustments in accordance with the actual

increase or decrease resulting from the change, imposition, or abolition of customs and excise duty and any other duty, levy, or tax, which, in terms of the law or regulation, is binding on the Respondent and demonstrably has an influence on the price of any supplies, or the rendering costs of any service, for the execution of the contract;

- 2.11 **"functionality"** means the measurement according to predetermined norms, as set out in the bid documents, of a service or commodity that is designed to be practical and useful, working or operating, taking into account, among other factors, the quality, reliability, viability and durability of a service and the technical capacity and ability of a bidder;
- 2.12 **"non-firm prices"** means all prices other than "firm" prices;
- 2.13 **"person"** includes reference to a juristic person;
- 2.14 **"QSE"** means any enterprise with an annual total revenue between R5 [five] million and R35 [thirty five] million as per the 2007 version of the B-BBEE Codes of Good Practice and means any enterprise with an annual total revenue of between R10 [ten] million and R50 [fifty] million as per the Revised Codes of Good Practice issued on 11 October 2013 in terms of Government Gazette No. 36928
- 2.15 **"rand value"** means the total estimated value of a contract in South African currency, calculated at the time of bid invitations, and includes all applicable taxes and excise duties;
- 2.16 **"subcontract"** means the primary Respondent's assigning or leasing or making out work to, or employing another person to support such primary Respondent in the execution of part of a project in terms of the contract;
- 2.17 **"total revenue"** bears the same meaning assigned to this expression in the Codes of Good Practice on Black Economic Empowerment, issued in terms of section 9(1) of the Broad-Based Black Empowerment Act and promulgated in the Government Gazette on 9 February 2007;
- 2.18 **"trust"** means the arrangement through which the property of one person is made over or bequeathed to a trustee to administer such property for the benefit of another person; and
- 2.19 **"trustee"** means any person, including the founder of a trust, to whom property is bequeathed in order for such property to be administered for the benefit of another person.

3. ADJUDICATION USING A POINT SYSTEM

- 3.1 The Bidder obtaining the highest number of total points for the evaluation criteria as enumerated in Section 2 of the RFQ will be awarded the contract, unless objective criteria justifies the award to another bidder.
- 3.2 Preference points shall be calculated after prices have been brought to a comparative basis taking into account all factors of non-firm prices and all unconditional discounts.
- 3.3 Points scored will be rounded off to 2 [two] decimal places.
- 3.4 In the event of equal points scored, the Bid will be awarded to the Bidder scoring the highest number of preference points for B-BBEE.
- 3.5 However, when functionality is part of the evaluation process and two or more Bids have scored equal points including equal preference points for B-BBEE, the successful Bid will be the one scoring the highest score for functionality.
- 3.6 Should two or more Bids be equal in all respect, the award shall be decided by the drawing of lots.

4. POINTS AWARDED FOR B-BBEE STATUS LEVEL OF CONTRIBUTION

- 4.1 In terms of the Preferential Procurement Regulations, 2011, preference points shall be awarded to

a Bidder for attaining the B-BBEE status level of contribution in accordance with the table below:

B-BBEE Status Level of Contributor	Number of Points [Maximum 10]
1	10
2	9
3	8
4	5
5	4
6	3
7	2
8	1
Non-compliant contributor	0

- 4.2 Bidders who qualify as EMEs in terms of the 2007 version of the Codes of Good Practice must submit a certificate issued by an Accounting Officer as contemplated in the CCA or a Verification Agency accredited by SANAS or a Registered Auditor. Registered auditors do not need to meet the prerequisite for IRBA's approval for the purpose of conducting verification and issuing EME's with B-BBEE Status Level Certificates.
- 4.3 Bidders who qualify as EMEs in terms of the Revised Codes of Good Practice issued on 11 October 2013 in terms of Government Gazette No. 36928 are only required to obtain a sworn affidavit on an annual basis confirming that the entity has an Annual Total Revenue of R10 million or less and the entity's Level of Black ownership.
- 4.4 In terms of the 2007 version of the Codes of Good Practice, Bidders other than EMEs must submit their original and valid B-BBEE status level verification certificate or a certified copy thereof, substantiating their B-BBEE rating issued by a Registered Auditor approved by IRBA or a Verification Agency accredited by SANAS.
- 4.5 The Department of Trade and Industry recently revised the Codes of Good Practice on 11 October 2013 [Government Gazette No. 36928]. The Revised Codes will replace the Black Economic Empowerment Codes of Good Practice issued on 9 February 2007. The Revised Codes provide for a transitional period ending 30 April 2015. During the transitional period, companies may elect to be measured in terms of the Revised Codes or the 2007 version of the Codes. Companies which are governed by Sector-specific Codes will be measured in terms of those Sector Codes.
- 4.6 **As such, Transnet will accept B-BBEE certificates issued based on the Revised Codes. Transnet will also continue to accept B-BBEE certificates issued in terms of the 2007 version of the Codes provided it was issued before 1 May 2015. Thereafter, Transnet will only accept B-BBEE certificates issued based on the Revised Codes.**
- 4.7 In terms of the Revised Codes of Good Practice, Bidders who qualify as QSEs must comply with all the elements of B-BBEE for the purposes of measurement. QSEs that are at least 51% or 100% Black owned are only required to obtain a sworn affidavit on an annual basis confirming that the entity has an Annual Total Revenue of R50 million or less and the entity's Level of Black ownership. Large enterprises must submit their original and valid B-BBEE status level verification certificate or a certified copy thereof, substantiating their B-BBEE rating issued by a Registered Auditor approved by IRBA or a Verification Agency accredited by SANAS.

- 4.8 A trust, consortium or joint venture will qualify for points for its B-BBEE status level as a legal entity, provided that the entity submits its B-BBEE status level certificate.
- 4.9 A trust, consortium or joint venture will qualify for points for their B-BBEE status level as an unincorporated entity, provided that the entity submits their consolidated B-BBEE scorecard as if they were a group structure and that such a consolidated B-BBEE scorecard is prepared for every separate bid.
- 4.10 Tertiary institutions and public entities will be required to submit their B-BBEE status level certificates in terms of the specialised scorecard contained in the B-BBEE Codes of Good Practice.
- 4.11 A person will not be awarded points for B-BBEE status level if it is indicated in the Bid documents that such a Bidder intends subcontracting more than 25% [twenty-five per cent] of the value of the contract to any other enterprise that does not qualify for at least the same number of points that such a Bidder qualifies for, unless the intended sub-Respondent is an EME that has the capability and ability to execute the subcontract.
- 4.12 A person awarded a contract may not subcontract more than 25% [twenty-five per cent] of the value of the contract to any other enterprise that does not have an equal or higher B-BBEE status level than the person concerned, unless the contract is subcontracted to an EME that has the capability and ability to execute the subcontract.
- 4.13 Bidders are to note that in terms of paragraph 2.1 of Statement 000 of the Revised Codes of Good Practice issued on 11 October 2013 in terms of Government Gazette No. 36928, any representation made by an entity about its B-BBEE compliance must be supported by suitable evidence or documentation. As such, Transnet reserves the right to request such evidence or documentation from Bidders in order to verify any B-BBEE recognition claimed.

5. B-BBEE STATUS AND SUBCONTRACTING

5.1 Bidders who claim points in respect of B-BBEE Status Level of Contribution must complete the following:

B-BBEE Status Level of Contributor _____ = _____ [maximum of **10** points]

Note: Points claimed in respect of this paragraph 5.1 must be in accordance with the table referenced in paragraph 4.1 above and must be substantiated by means of a B-BBEE certificate issued by a Verification Agency accredited by SANAS or a Registered Auditor approved by IRBA or a sworn affidavit in the case of an EME or QSE.

5.2 Subcontracting:

Will any portion of the contract be subcontracted? YES/NO [delete which is not applicable]

If YES, indicate:

- (i) What percentage of the contract will be subcontracted?
- (ii) The name of the sub-Respondent.....
- (iii) The B-BBEE status level of the sub-contract
- (iv) Is the sub-Respondent an EME? YES/NO

5.3 Declaration with regard to Company/Firm

- (i) Name of Company/Firm.....
- (ii) VAT registration number.....
- (iii) Company registration number.....
- (iv) Type of Company / Firm [TICK APPLICABLE BOX]

- Partnership/Joint Venture/Consortium
- One person business/sole propriety
- Close Corporations
- Company (Pty) Ltd

(v) Describe Principal Business Activities

.....

(vi) Company Classification [TICK APPLICABLE BOX]

- Manufacturer
 - Supplier
 - Professional Service Provider
 - Other Service Providers, e.g. Transporter, etc.
- (vii) Total number of years the company/firm has been in business.....

BID DECLARATION

I/we, the undersigned, who warrants that he/she is duly authorised to do so on behalf of the company/firm, certify that points claimed, based on the B-BBEE status level of contribution indicated in paragraph 4 above, qualifies the company/firm for the preference(s) shown and I / we acknowledge that:

- (i) The information furnished is true and correct.
- (ii) In the event of a contract being awarded as a result of points claimed as shown in paragraph 4 above, the Respondent may be required to furnish documentary proof to the satisfaction of Transnet that the claims are correct.
- (iii) If the B-BBEE status level of contribution has been claimed or obtained on a fraudulent basis or any of the conditions of contract have not been fulfilled, Transnet may, in addition to any other remedy it may have:
 - (a) disqualify the person from the bidding process;
 - (b) recover costs, losses or damages it has incurred or suffered as a result of that person's conduct;
 - (c) cancel the contract and claim any damages which it has suffered as a result of having to make less favourable arrangements due to such cancellation;
 - (d) restrict the Bidder or Respondent, its shareholders and directors, and/or associated entities, or only the shareholders and directors who acted in a fraudulent manner, from obtaining business from Transnet for a period not exceeding 10 years, after the *audi alteram partem* [hear the other side] rule has been applied; and/or
 - (e) forward the matter for criminal prosecution.

WITNESSES:

- 1.
- 2.

SIGNATURE OF BIDDER

DATE:.....

COMPANY NAME:

ADDRESS:.....

"PREVIEW COPY ONLY"

RFQ FOR KOEDOESPOORT DEPOT (SIGNALS) REPLACE SIGNAL POWER EQUIPMENT

Section 8: CERTIFICATE OF ATTENDANCE OF RFQ BRIEFING

It is hereby certified that –

1. _____

2. _____

Representative(s) of _____ [name of entity]
attended the RFQ briefing in respect of the proposed Services to be rendered in terms of this RFQ on
_____ 20____

TRANSNET'S REPRESENTATIVE

RESPONDENT'S REPRESENTATIVE

DATE _____

DATE _____

EMAIL _____

"PREVIEW COPY ONLY"

RFQ FOR KOEDOESPOORT DEPOT (SIGNALS) REPLACE SIGNAL POWER EQUIPMENT

Section 9: SCHEDULE OF PLANT AND EQUIPMENT

Schedule of plant and equipment to be used in the execution of this agreement in terms of the Master Agreement. The respondent must state which plant is immediately available and which will be ordered for.

(i) **Plant immediately available for work tendered for:**

(ii) **Plant on order and which will be available for work tendered for:**

(iii) **Plant to be acquired for the work tendered for:**

"PREVIEW COPY ONLY"

RFQ FOR KOEDOESPOORT DEPOT (SIGNALS) REPLACE SIGNAL POWER EQUIPMENT

Section 10: CLAUSE BY CLAUSE COMPLIANCE TO PROJECT SPECIFICATION

Clause Nr	Yes	No	Comments for non-compliance to project specification
1			
1.1			
1.1.2			
1.1.3			
1.1.4			
1.2			
1.2.1			
1.2.2			
1.3			
1.3.1			
1.4			
1.4.1			
1.4.2			
1.5			
1.5.1			
1.5.2			
1.5.3			
1.6.1			
1.6.1.1			
1.6.1.2			
1.6.1.3			
1.6.1.4			
1.6.1.5			
1.6.1.6			
1.6.1.7			
1.6.1.8			
1.6.1.9			
1.6.1.10			

"PREVIEW COPY ONLY"

Respondent's Signature

Date & Company Stamp

1.7			
1.8			

"PREVIEW COPY ONLY"

Respondent's Signature

Date & Company Stamp



TRANSNET
freight rail

A Division of Transnet SOC Limited

TECHNOLOGY MANAGEMENT

SPECIFICATION

POWER DISTRIBUTION CUBICLES FOR SIGNAL INSTALLATIONS

Author: Chief Engineering Technician
Infrastructure Technical P Doorewaard

Approved: Senior Engineer
Technology Management RA Langley

Authorised: Principal Engineer
Technology Management J Kannemeyer

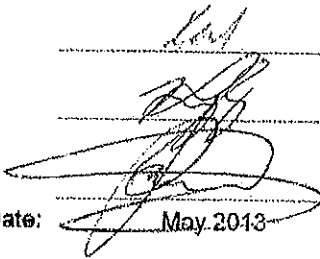
Date:  May 2013

Circulation Restricted To:

Transnet and Relevant Third Parties

© This document as a whole is protected by copyright. The information herein is the sole property of Transnet SOC Ltd. It may not be used, disclosed or reproduced in part or in whole in any manner whatsoever, except with the written permission of and in a manner permitted by the proprietors.

TABLE OF CONTENTS

1.	SCOPE	3
2.	APPLICABLE DOCUMENTS	3
3.	REQUIREMENTS	4
4.	DOCUMENTATION	5
5.	QUALITY ASSURANCE	5

"PREVIEW COPY ONLY"

1. SCOPE

This document serves as a specification for Power Distribution Cubicles used in Signal installations to establish performance and test requirements and as basis for the procurement thereof.

2. APPLICABLE DOCUMENTS

2.1 Transnet Documents

2.1.1

- | | |
|---------------------|---|
| 2.1 SANS 1973-1 | Low-voltage switchgear and control gear ASSEMBLIES
Part 1: Type-tested ASSEMBLIES with stated deviations and a rated short-circuit withstand strength above 10kA |
| 2.2 SANS 156 | Moulded-case circuit breakers |
| 2.3 SANS 10142-1 | The wiring of premises Part 1: Low voltage installations |
| 2.4 SANS 60439-1 | Low voltage switchgear and control gear assemblies.
Part 1: Type tested and partially type-tested assemblies |
| 2.5 SANS 60947-1 | Low voltage switchgear and control gear Part 1: General rules |
| 2.6 SANS 60947-2 | Low voltage switchgear and control gear Part 2: Circuit breakers |
| 2.7 SANS 60947-3 | Low voltage switchgear and control gear Part 3: Switches, disconnectors, switch-disconnectors and fuse-combination units |
| 2.8 SANS 60947-4-1 | Low voltage switchgear and control gear Part 4-1: Contactors and motor starters - electromechanical contactors and motor starters |
| 2.9 SANS 60947-5-1 | Low voltage switchgear and control gear Part 5-1: Control circuit devices and switching elements - Electromechanical control circuit devices |
| 2.10 SANS 60947-7-1 | Low voltage switchgear and control gear Part 7-1: Ancillary equipment – Terminal blocks for copper conductors |
| 2.11 SANS 60529 | Degrees of protection provided by enclosures (IP Code) |
| 2.12 SANS 1274 | Coatings applied by the powder-coating process |
| 2.13 IEC 60664-1 | Insulation coordination for equipment within low voltage systems – Part 1: Principles, requirements and tests. |
| 2.14 SANS 1195 | Busbars |
| 2.15 SANS 1574 | Electric flexible cores, cords and cables with solid extruded dielectric insulation |

3. REQUIREMENTS

3.1 Physical characteristics

- 3.1.1 The cubicle size shall be approved by Transnet Freight Rail.
- 3.1.2 The cubicle layout shall be approved by Transnet Freight Rail.
- 3.1.3 The enclosure shall be constructed of 2,0mm mild steel plate unless otherwise specified.
- 3.1.4 The cubicle shall be sufficiently strengthened to prevent deformation during transport, delivery and installation.
- 3.1.5 The layout of equipment inside the cubicle shall be of such a nature that it is easily accessible for fault finding and replacements.
- 3.1.6 All equipment shall be clearly labelled by means of durable markings to enable ease of identification.

3.2 Environmental conditions

- 3.2.1 Natural convection cooling is required.
- 3.2.2 The equipment must be capable of operation to specification under the following conditions:

Ambient temperatures between -5°C and $+50^{\circ}\text{C}$
Maximum relative humidity of 95% (non condensing);
Dusty and corrosive conditions;
Altitude from 0 – 1800m.

- 3.2.3 The protection degree shall be IP4X according to IEC 60529 – Protected against objects greater than 1mm.

3.3 Metal treatment

- 3.3.1 As per 2.12.

3.4 Final paint finish

- 3.4.1 As per 2.12. The final paint coat shall be applied to produce a uniform dry film thickness of not less than 90 microns.
- 3.4.2 The final paint coat shall be tested for uniform thickness.
- 3.4.3 The colour of the paint shall be structured "light grey" RAL 7032.

3.5 Plating specification

- 3.5.1 All steel metal parts, which are identified for plating, shall be zinc-plated to a minimum thickness of 8 microns.
- 3.5.2 All copper bus bars, which are identified for plating shall be tin-plated to a minimum thickness of 8 microns.

3.6 Bus bars

- 3.6.1 All bus bars, where specified, shall be insulated by means of heat shrink or air shrink sleeves. Connection points shall not be sleeved.

3.7 Access to cubicle

- 3.7.1 The cubicle shall be fitted with hinged doors at the front. The rear shall be closed off by a "lift out" type panel with approved vent size at the top.
- 3.7.2 The doors shall be adjusted to ensure an even gap between doors and between doors and side frames.

3.8 Electrical

- 3.8.1 Power conductors shall be single flex type 600/1000 volts (par 2.15) and sized to rated load plus 20%.
- 3.8.2 Control wiring shall be panel flex type 300/500 volts (par 2.15) with a minimum cross section area of 1,5mm².
- 3.8.3 Control wires shall be numbered at both ends in accordance with the relevant wiring diagram.
- 3.8.4 Power conductors shall be numbered at both ends in accordance with the relevant wiring diagram.
- 3.8.5 Terminal blocks shall be of sufficient size to accommodate wiring and shall be DIN rail mounted.
- 3.8.6 Not more than one wire may be crimped or soldered into any terminal. A maximum of three wires may be connected to a bolt type terminal.
- 3.8.7 The wiring shall be neatly treed in a total access U channel with drop-on cover.
- 3.8.8 Terminal blocks shall be suitably numbered.

3.9 Ergonomics

- 3.9.1 Analogue meters shall be flush mounted on the front door for displaying voltage and current.
- 3.9.2 In case of three phase cubicles, switches for displaying voltage and current per phase shall be mounted on the front door.
- 3.9.3 The on/off main supply switch shall be mounted on the front door.
- 3.9.4 All circuit breakers and related switching equipment shall be mounted inside the cubicle.

4. DOCUMENTATION

- 4.1 Drawings shall show the following:
- Front view of cubicle with equipment mounted and numbered for reference purposes.
 - Equipment layout inside cubicle and numbered for reference purposes.
 - Detailed wiring diagram numbered for purpose of reference and fault finding.
 - Parts list referencing the quantity, description, rating and manufacturer part number.

5. QUALITY ASSURANCE

- 5.1 Manufacturers shall have a quality management program in place. (ISO standards)
- 5.2 A final test certificate shall be provided and signed off by the responsible person/s of each test as required below:
- Dimensional inspection
 - Identification inspection
 - Paint thickness inspection
 - Component inspection
 - Mechanical assembly inspection
 - Insulation tests
 - Electrical and functional test

END OF SPECIFICATION



TRANSNET
freight rail

A Division of Transnet SOC Limited

TECHNOLOGY MANAGEMENT

SPECIFICATION

VALVE REGULATED LEAD ACID BATTERIES FOR USE IN SIGNAL INSTALLATIONS

Author: Chief Engineering Technologist
Rail Network P Doorewaard

Approved: Senior Engineer
Technology Management RA Langley

Authorised: Principal Engineer
Technology Management J kannemeyer

Date: September 2013

Circulation Restricted To:

Transnet and Relevant Third Parties

© This document as a whole is protected by copyright. The information herein is the sole property of Transnet SOC Ltd. It may not be used, disclosed or reproduced in part or in whole in any manner whatsoever, except with the written permission of and in a manner permitted by the proprietors.

1. SCOPE

1.1 Identification.

12V Valve regulated lead acid (AGM) front terminal 10 year + design life batteries.

1.2 Item overview.

The valve regulated lead acid (VRLA) batteries are required to provide standby power to Signal relay rooms for a minimum of 10 hours. Size of battery shall be specified by Transnet Freight Rail.

1.3 Document overview.

The VRLA batteries within Transnet Freight Rail (Train Authorisation Systems) shall comply with the requirements as set out in this document. This document may therefore be used for item purchasing and approval.

2. REQUIREMENTS

The requirements as set out below must be complied with. It is required that a statement be issued stating compliance per clause as well as the actual guaranteed technical data of the equipment offered. Failure to submit a statement of compliance shall automatically disqualify the tenderer.

Offers which include deviations of a minor nature from the terms of this specification will be considered at the discretion of Transnet Freight Rail (Train Authorisation systems).

3. BATTERY FEATURES

3.1 The battery shall be of the Absorbent Glass Mat (AGM) type technology for efficient gas recombination and freedom from electrolyte maintenance or water adding.

3.2 The battery shall be of the front terminal type.

3.3 Minimum 10 year design life guaranteed under float conditions at a constant 25 deg. Celsius.

3.4 The battery must be suitable for long discharge periods, typically 10 hours and recharge of C/8.

3.5 Batteries shall have internationally recognised certification.

3.6 The battery shall have a UL 94 V0 rated flame retardant casing.

3.7 The battery manufacturer shall be registered to ISO9001 and ISO14001.

3.8 The battery must be compliant with SANS 60896.

4. DOCUMENTATION

4.1 Complete documentation including detailed Material safety data sheet shall be submitted

4.2 Documents to record regular test measurements shall be provided.

5. PRE DELIVERY PREPARATION

5.1 Batteries shall undergo a refresher charge upon arrival at the premises of the distributor. Thereafter the batteries shall be discharged to 1.8vpc over a period of 2 - 3 hours to eliminate any potential bad battery. Regular voltage measurements per block shall be taken when discharging.

5.2 Batteries shall be recharged at 10% of AH rating at voltage 2.4vpc. The batteries shall be connected in parallel (Battery string of 32 blocks may be split into 2 x 16 blocks) to ensure proper equalisation.

5.3 Pallets shall be marked to ensure that battery strings as charged are not mixed.

5.4 Transnet Freight Rail reserves the right to witness the preparation process.

6. Warranty

6.1 Transnet Freight Rail requires a 3 year warranty period against faulty workmanship.

END OF SPECIFICATION

"PREVIEW COPY ONLY"

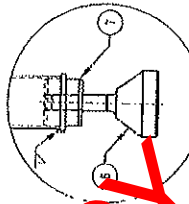
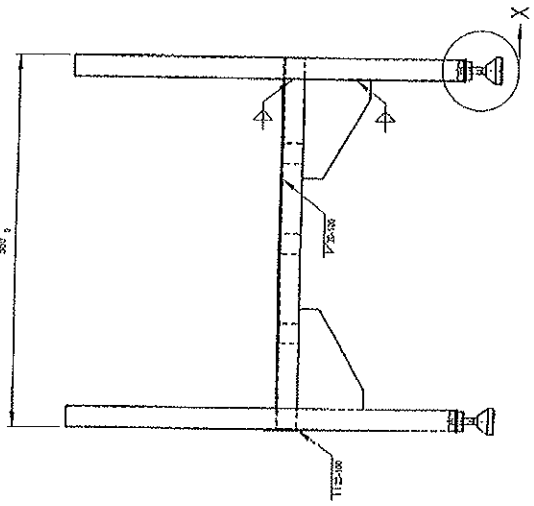
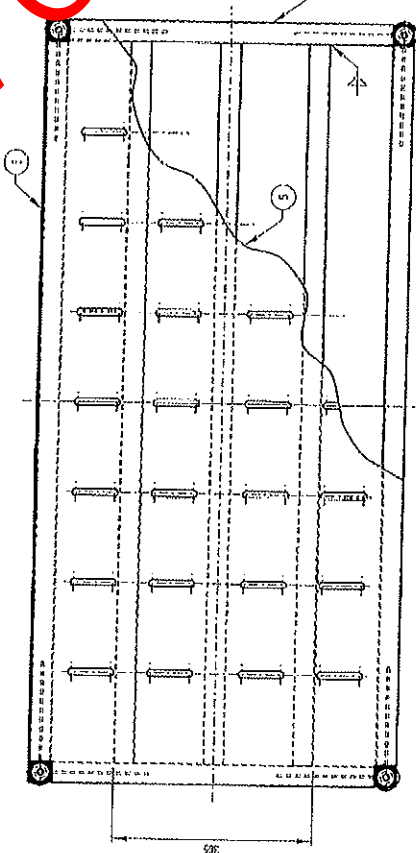

FINISH:
 1. POWDER COAT TO SANS 192 AFTER WELDING
 2. FIT 32mm SQ PLASTIC FERRULES ON ALL OPEN ENDS

ITEM NO	DESCRIPTION	QTY	STORES ITEM NO	DRAWING NO
1	FLAT STRIP STEEL 1.56 x 50 x 2 THICK	1	-	-
2	BATTERY STAND FOOT BUSH	4	-	BBG1500
3	BATTERY STAND FOOT	4	-	BBG1499
4	BATTERY SURFACE	1	-	BBG1502
5	BUSH	8	-	BBG1501
6	STEEL SQUARE TUBING 32 x 32 x 1.6 x 566 LONG	2	-	-
7	STEEL SQUARE TUBING 32 x 32 x 1.6 x 1081 LONG	2	-	-
8	STEEL SQUARE TUBING 32 x 32 x 1.6 x 895 LONG	4	-	-

© COPYRIGHT PROTECTED, PREPARED BY CENTRAL DRAWING OFFICE
 DIMENSIONS : mm SCALE : 1:5
 TOLERANCE : UN ±0.5 ANG ±1° ITEM NO :
 MATERIAL :
 VERSION INFO :
 DO REC : GOC/ 8203
 ECP REF :
 DRAWN : CJ Mares
 DESIGNED :
 CHECKED : J. A. Vanden

STEEL BATTERY STAND FOR VRLA BATTERIES
 IN RELAY ROOMS
 8 x FRONT TERMINAL

APPROVED
 AUTHORIZED

TRANSNET
 freightroll
 BBG1023
 VERSION 1

"PREVIEW COPY ONLY"

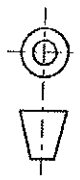

© COPYRIGHT PROTECTED. PREPARED BY CENTRAL DRAWING OFFICE

DIMENSIONS : mm SCALE : 1 : 1
 TOLERANCE : LINE 0.5 ANG 2° ITEM NO : -
 MATERIAL : ROUND BAR STEEL 240 x 65 LONG
 VERSION INFO : -

DO REF: C007/8023 ECP REF: -
 DRAWN: CJ Marais

APPROVED
 AUTHOR SEE DESIGNER:

FOOT FOR STEEL BATTERY
 STAND IN RELAY ROOMS
 (8 x FRONT AND TOP TERMINAL)

TRANSNET
Freight rail

BBG1499
 VERSION 1

A4

CHECKED: H v Vautren

"PREVIEW COPY ONLY"

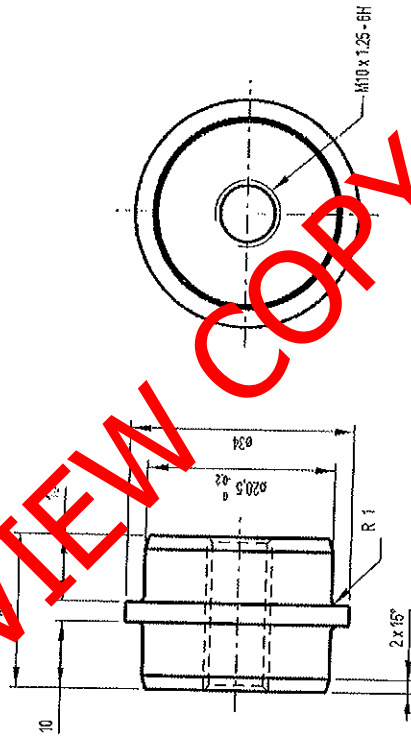

© COPYRIGHT PROTECTED. PREPARED BY CENTRAL DRAWING OFFICE

DIMENSIONS : mm
TOLERANCE : LINES 0.5 ANG ± 2° ITEM 40 : -
MATERIAL : ROUND BAR. STEEL ø34 x 23 LONG
VERSION INFO : -

+

DO REF: C007/8023
ECP REF: -

DRAWN: CJ Marais

APPROVED

AUTHORISED

DESIGNED:

CHECKED: H v Vuuren

A4

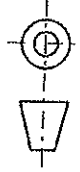

TRANSNET
Freight rail

BBG1500
VERSION 1

FOOT BUSH FOR STEEL BATTERY
STAND IN RELAY ROOMS
(8 x FRONT AND TOP TERMINAL)

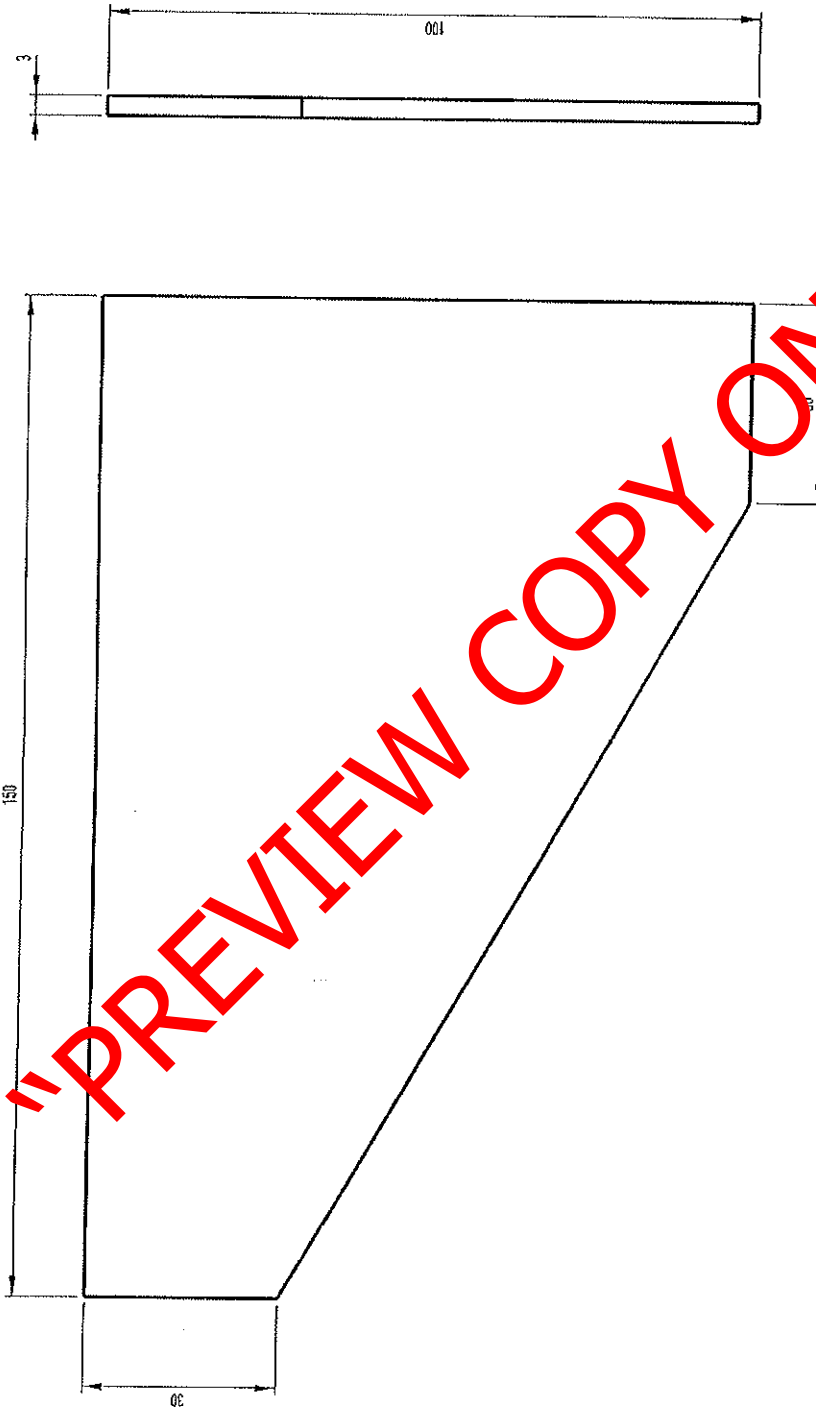

"PREVIEW COPY ONLY"

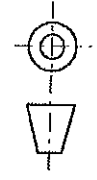

© COPYRIGHT PROTECTED. PREPARED BY CENTRAL DRAWING OFFICE

DIMENSIONS : mm SCALE : 1 : 1
 TOLERANCE : LINE 1 ANGE - ITEM 100 : -
 MATERIAL : STEEL SHEET 150 x 100 x 3 THICK
 VERSION INFO : -

APPROVED
 +
 AUTHORIZED

GUSSET FOR STEEL BATTERY
 STAND IN RELAY ROOMS
 (8 X FRONT TERMINAL)

TRANSNET
 freight rail
 BBC1501
 VERSION 1

DO REF: CDD/8023 ECP REF: - DRAWN: CJ Marais DESIGNED: - CHECKED: H v Vauren A4

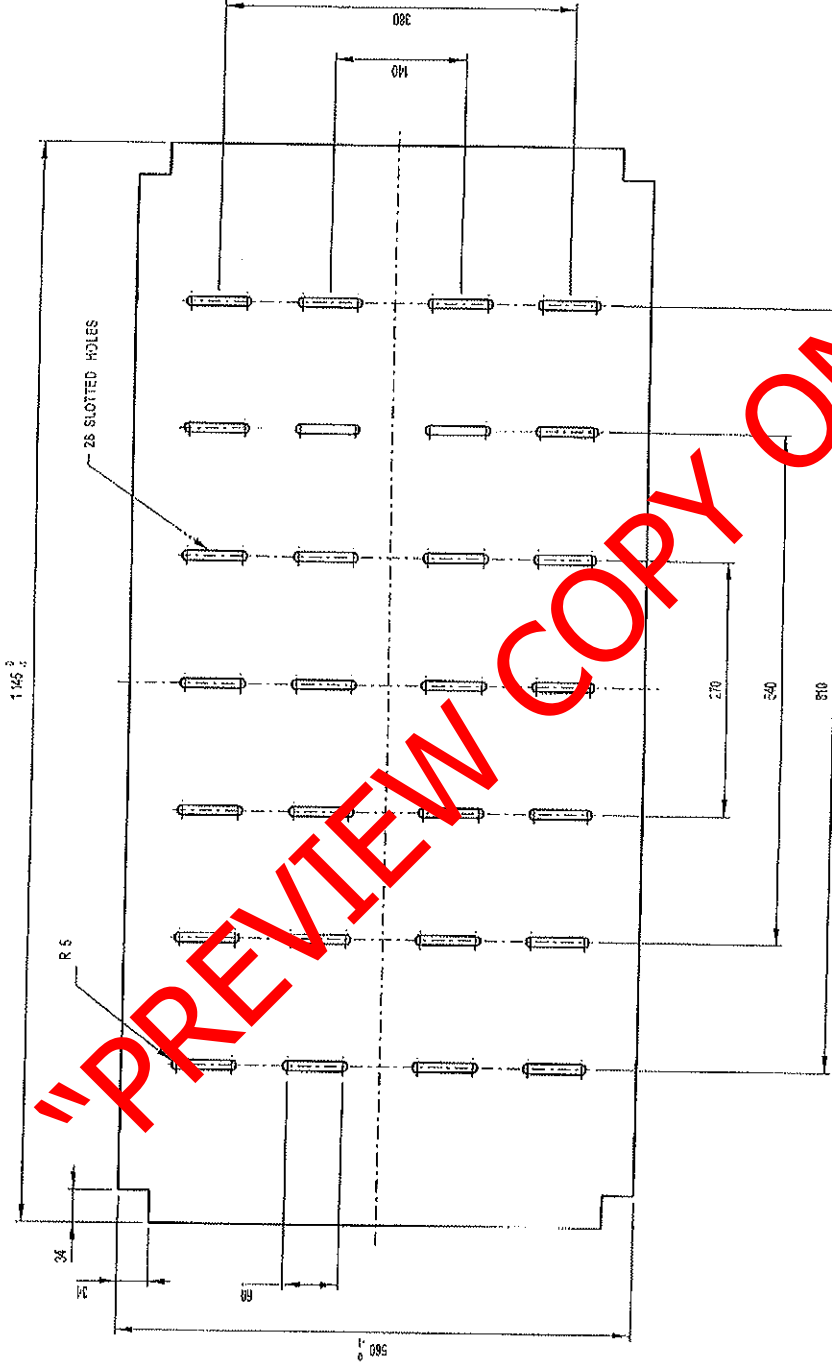

"PREVIEW COPY ONLY"

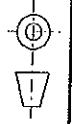

© COPYRIGHT PROTECTED. PREPARED BY CENTRAL DRAWING OFFICE
 DIMENSIONS : mm SCALE : 1:1.5
 TOLERANCE : LINE 0.5 ANG. 0.125
 MATERIAL : STEEL SHEET 1445 x 550 x 1.6 THICK
 VERSION INFO :

TRANSTNET
 freight rail
 BBG1502
 VERSION 1

BATTERY SURFACE FOR STEEL BATTERY STAND
 IN RELAY ROOMS
 (8 X FRONT TERMINAL)

DESIGNED: +
 APPROVED: +
 AUTHORIZED: +
 CHECKED: H v Vukren

DO REF: 5001/0023
 ECP REF: +
 DRAWN: CJ Naras
 A3

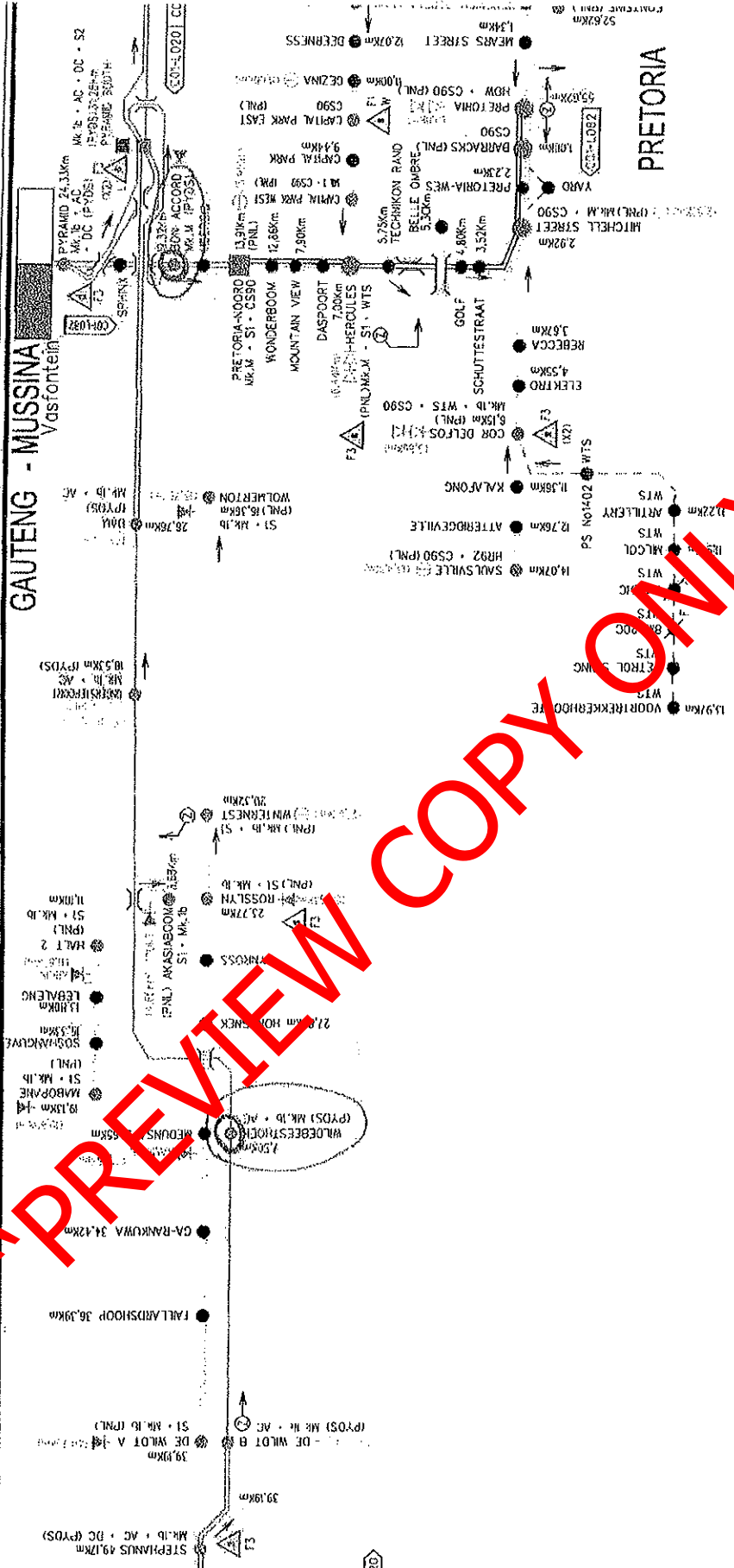

PRETORIA

GAUTENG - MUSSINA
Vastfontein

PREVIEW COPY ONLY

I ANCI AAGTE

"PREVIEW COPY ONLY"

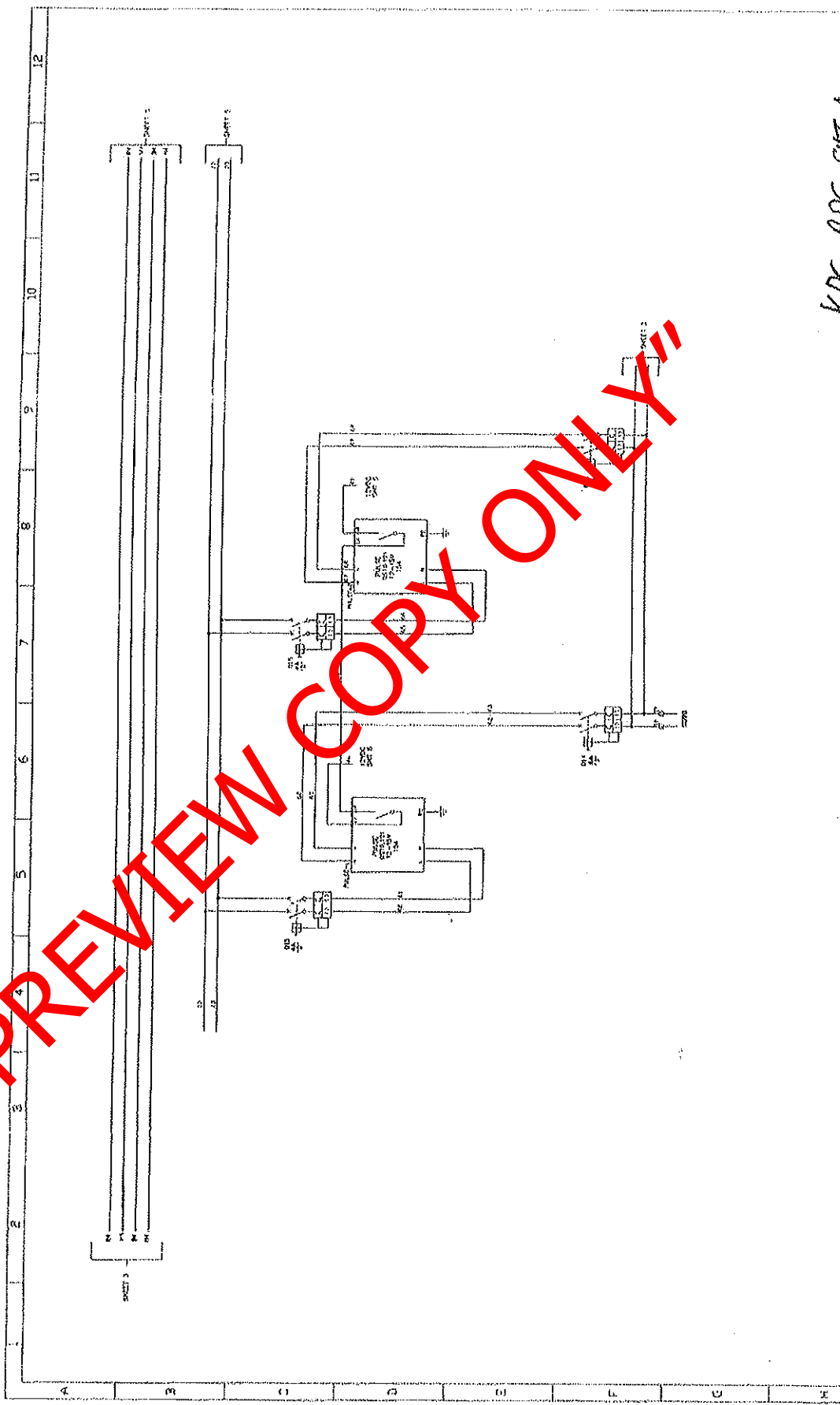

KDC-PDC SAT A

"PREVIEW COPY ONLY"

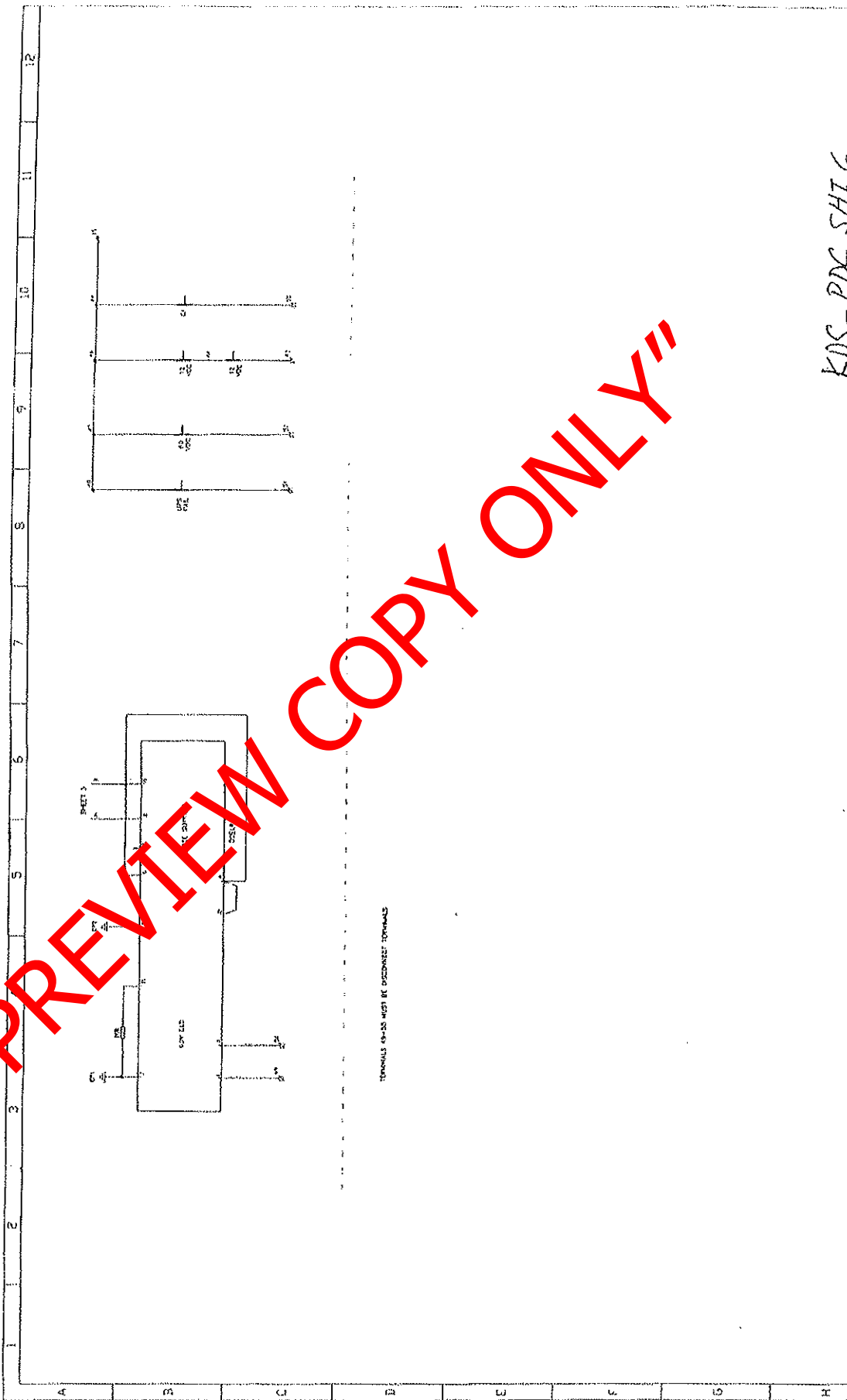

KDS - PDC SHI 6