



Transnet SOC Limited  
Transnet RME

REQUEST FOR QUOTATION

BOARD LIST TFR RME  
TRANSNET FREIGHT RAIL - RME  
PROCUREMENT DEPARTMENT  
2000

Registration Number: 1990/000900/30  
Vat Number : 4720103177

**Attention:**  
TFR Tender Board.  
Telephone Number :  
Fax Number :  
Vendor Number :2004815

**Quotation Deadline Date : 14.01.2016**  
**Quotation Deadline Time : 12:00**

**REQUEST for QUOTATION**  
Transnet RME  
**RFQ Number / Date**  
6000240856 / 05.01.2016  
**Contact Person / Telephone**  
Eddie Quinn / 035 906 7347  
**Return to FAX Number/EMAIL**  
0865 15997 / TCPtendersRichardsBay@Transnet.net

PREVIEW COPY ONLY

Item	Material	Description	RFQ Qty	UoM	Required Del date	Confirm Del date	Unit Price Excl	Total Price Excl
00010		Dropper Clip Catenary 1	200	ea	08.02.2016			
Supply & Deliver, 200 x Dropper Clips, for Catenary Wire: 60mm Square, as per the attached Drawing No: CEE-TND-5. (Req: 10503458) Deliver To: 1 Morris Rd - Empangeni Rail - Old Goods Shed. Contact: Mr Pierre Crocker Tel: 035-905 3638 / 083 279 0437.								
00020		Dropper Clip Catenary 1	1,500	ea	08.02.2016			
Supply & Deliver, 1500 x Dropper Clips, for Catenary Wire: 80mm Square, as per the attached Drawing No: CEE-TND-5. (Req: 10503459) Deliver To: 1 Morris Rd - Empangeni Rail - Old Goods Shed. Contact: Mr Pierre Crocker Tel: 035-905 3638 / 083 279 0437.								
00030		Dropper Clip Contact 16	500	ea	08.02.2016			
Supply & Deliver, 500 x Dropper Clips, for Contact Wire: 161mm square, as per the attached Drawing No: CEE-TND-22 or BBB8332. (Req: 10503460)								



REQUEST FOR QUOTATION

Transnet SOC Limited  
 Transnet RME  
 BOARD LIST TFR RME  
 TRANSNET FREIGHT RAIL - RME  
 PROCUREMENT DEPARTMENT  
 2000  
 YOUR VAT NUMBER WITH US: NOT

Registration Number: 1990/000900/30  
 Vat Number : 4720103177

**Attention:**  
 TFR Tender Board.  
 Telephone Number :  
 Fax Number :  
 Vendor Number :2004815

**Quotation Deadline Date : 14.01.2016**  
**Quotation Deadline Time : 12:00**

**REQUEST for QUOTATION**  
 Transnet RME  
**RFQ Number / Date**  
 6000240856 / 05.01.2016  
**Contact Person / Telephone**  
 Eddie Quinn / 035 906 7347  
**Return to V / X Number/EMAIL**  
 0865 15997 / TCPtendersRichardsBay@Transnet.net

Item	Material	Description	RFQ Qty	UoM	Required Del date	Confirm Del date	Unit Price Excl	Total Price Excl
------	----------	-------------	---------	-----	-------------------	------------------	-----------------	------------------

Deliver To: 1 Morris Rd - Empangeni Rail - Old Goods Shed.  
 Contact: Mr Pierre Crocker Tel: 035-905 3638 / 083 279 0437.

00040		Dropper Sleeve/ferrules	3,000	ea	08.02.2016			
-------	--	-------------------------	-------	----	------------	--	--	--

Supply & Deliver, 3000 x Dropper Sleeve/Ferrules, as per the attached Drawing No: CEE-TX-79. (Req: 10503461)  
 Deliver To: 1 Morris Rd - Empangeni Rail - Old Goods Shed.  
 Contact: Mr Pierre Crocker Tel: 035-905 3638 / 083 279 0437.

00050		Sealing Cap Struts	200	ea	08.02.2016			
-------	--	--------------------	-----	----	------------	--	--	--

Supply & Deliver, 200 x Sealing Caps, for Cantilever Struts, as per the attached Drawing No: TNA-1. (Req: 10503462)  
 Deliver To: 1 Morris Rd - Empangeni Rail - Old Goods Shed.  
 Contact: Mr Pierre Crocker Tel: 035-905 3638 / 083 279 0437.

Transnet Limited t/a Transnet Freight Rail (R.M.E.) # Richards Bay, hereby invite your company to submit a detailed quotation for:

The Supply & Delivery of Various O.H.T.E. Equipment, (As requested above.)



**Transnet SOC Limited**  
**Transnet RME**  
 BOARD LIST TFR RME  
 TRANSNET FREIGHT RAIL - RME  
 PROCUREMENT DEPARTMENT  
 2000  
 YOUR VAT NUMBER WITH US: NOT

**REQUEST FOR QUOTATION**

**Registration Number: 1990/000900/30**  
**Vat Number : 4720103177**

**Attention:**  
 TFR Tender Board,  
 Telephone Number :  
 Fax Number :  
 Vendor Number :2004815

**Quotation Deadline Date : 14.01.2016**  
**Quotation Deadline Time : 12:00**

**REQUEST for QUOTATION**  
 Transnet RME  
**RFQ Number / Date**  
 6000240856 / 15.01.2016  
**Contact Person / Telephone**  
 Eddie Quinn / 035 906 7347  
**Return to FAX Number/EMAIL**  
 0865159978 / TCPtendersRichardsBay@Transnet.net

Item	Material	Description	RFQ Qty	UoM	Require Del date	Confirm Del date	Unit Price Excl	Total Price Excl
------	----------	-------------	---------	-----	------------------	------------------	-----------------	------------------

All technical queries relating to this invitation may be addressed to;  
 Mr. Pierre Crocker Tel: 083 279 0437 / 035-905 3638.

All tender related queries pertaining to this invitation may be addressed to;  
 Mr. Eddie Quinn, Tel: 035 # 906 7347.

The closing time for receipt of your official quotations is 12:00 hours on ~~Monday~~ **THURSDAY**, 14 January 2016.

Transnet desires a validity period of 90 (Ninety) days from the closing date of this RFQ.

Telephonic, Hand delivered and Late quotes will not be accepted.  
 All quotations should be clearly marked, and may be faxed or e-mailed to:  
 Miss Yogeshnie Gengan, Tender & Fax Assistant,  
 Fax No: 086 515 9978 and / or  
 e-mailed to: TCPtendersRichardsBay@transnet.net

The contractor's address and identification details have to be shown on each quotation submitted.

*N.B.*

- Please submit the following documents with your quotation;
- \* Valid Tax Clearance certificate.
  - \* Copy of your latest B.B.B.E.E. Certificate.

**Failing to submit a valid Tax Clearance Certificate could result in your quotation to be disqualified / not accepted but, not submitting or submitting an expired BBEE Certificate, will result in scoring zero (0) points for evaluation purposes.**



**Transnet SOC Limited**  
**Transnet RME**  
 BOARD LIST TFR RME  
 TRANSNET FREIGHT RAIL - RME  
 PROCUREMENT DEPARTMENT  
 2000  
 YOUR VAT NUMBER WITH US: NOT

**REQUEST FOR QUOTATION**

**Registration Number: 1990/000900/30**  
**Vat Number : 4720103177**

**Attention:**  
 TFR Tender Board.  
 Telephone Number :  
 Fax Number :  
 Vendor Number :2004815

**Quotation Deadline Date : 14.01.2016**  
**Quotation Deadline Time : 12:00**

**REQUEST for QUOTATION**  
 Transnet RME  
**RFQ Number / Date**  
 6000240856 / 05.01.2016  
**Contact Person / Telephone**  
 Eddie Quinn / 085 906 7347  
**Return to V / X Number/EMAIL**  
 0865 15997 / TCPtendersRichardsBay@Transnet.net

Item	Material	Description	RFQ Qty	UoM	Require Del date	Confirm Del date	Unit Price Excl	Total Price Excl
------	----------	-------------	---------	-----	------------------	------------------	-----------------	------------------

Note: #Transnet may not necessarily accept the lowest or any other offer and reserves the right to select in its favor any or, a portion of any offer made"  
 If you have been contacted directly by the Supply Chain Office (Via a RFQ.), and you are unable to quote for these items, please submit a NO QUOTE.  
 Otherwise we look forward to receive your detailed quote by the date and time stated.

Yours faithfully,

"PREVIEW COPY ONLY"



**Transnet SOC Limited**  
**Transnet RME**  
 BOARD LIST TFR RME  
 TRANSNET FREIGHT RAIL - RME  
 PROCUREMENT DEPARTMENT  
 2000  
 YOUR VAT NUMBER WITH US: NOT

## REQUEST FOR QUOTATION

**Registration Number: 1990/000900/30**  
**Vat Number : 4720103177**

**Attention:**

TFR Tender Board.  
 Telephone Number :  
 Fax Number :  
 Vendor Number : 2004815

**Quotation Deadline Date : 14.01.2016**  
**Quotation Deadline Time : 12:00**

**REQUEST for QUOTATION**

Transnet RME

**RFQ Number / Date**

6000240856 / 15.01.2016

**Contact Person / Telephone**

Eddie Quinn / 055 906 7347

**Return to FAX Number/EMAIL**

0865 15997 / TCPTendersRichardsBay@Transnet.net

**Delivery Address**

TFR RME Richards Bay  
 Old Naval Base, Commodores Clo  
 Meerensee, Richards Bay  
 3900

This RFQ is subject to the following conditions:

1. Price/s : The price/s quoted in SA currency and is excluding of VAT
2. Delivery : The price/s quoted should include delivery cost to the delivery address stated on the RFQ
3. Returnables : A valid tax clearance certificate and BBBEE certificate from a SANAS accredited verification agency attached to quotation for all quotes above R30 000.  
Please note that only the official Transnet RFQ will be accepted and all other correspondence to be attached to the original
4. Safety : To confirm to Transnet Freight Rail RME Health & Safety plan and specification; HAS-std-0001, copy available on request.
5. Confirmation: To confirm your participation in this tender process please sign and return this document as immediate effect prior to the quotation deadline.
6. Negotiations: The Employer may elect to negotiate the final terms of the contract/order with the preferred tenderer in accordance with Clauses F.2.17 and F.3.13 of the CIDB Standard Conditions of Tender. A copy of which is available upon request.
7. Quotes will not be acceptable if not sending to the given fax or e-mail (please do not CC any buyer)
8. Should your company not receive any response from Transnet within 30 days of closing of a RFQ, please accept that your quotation was unsuccessful.

\_\_\_\_\_  
 Signature

\_\_\_\_\_  
 Date

PR 10503458 + PR 10503459.

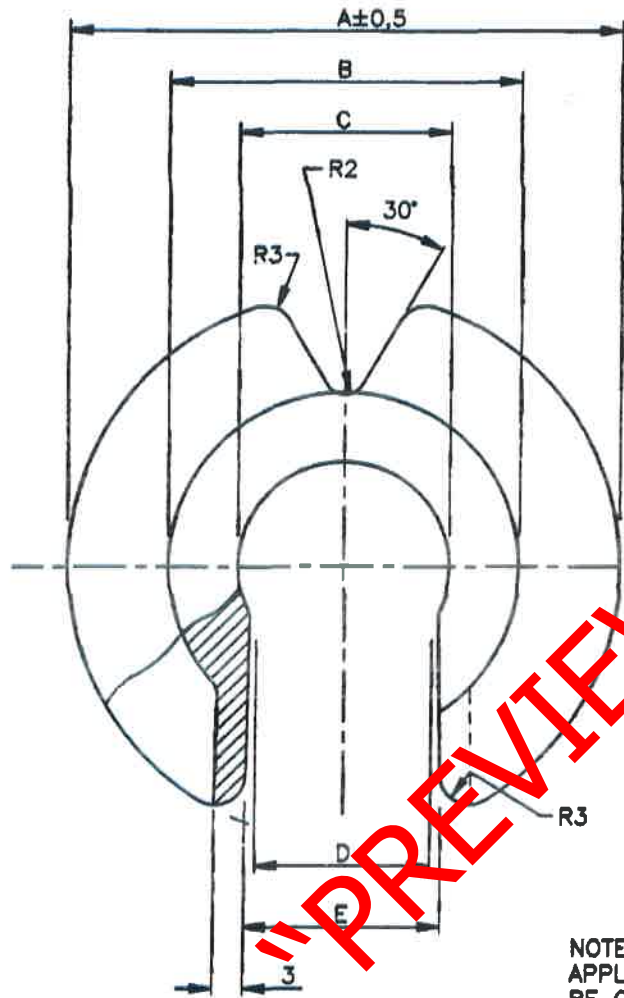

CATENARY	A	B	C	D	E	ITEM NO
80mm <sup>2</sup>	∅38	∅18	∅10,8	9,6	9 <sup>+1</sup> <sub>0</sub>	54/6840
100mm <sup>2</sup>	∅40	∅20,1	∅12,1	10,1	10 <sup>+1</sup> <sub>0</sub>	54/16861
* 180mm <sup>2</sup>	∅46,5	∅26,4	∅15,9	14,1	13 <sup>+2</sup> <sub>0</sub>	54/16836
250mm <sup>2</sup>	∅54	∅33,9	∅20,5	18,3	16 <sup>+3</sup> <sub>0</sub>	54/16848
** 530mm <sup>2</sup>	∅68	∅48,1	∅27,4	26	25 <sup>+4</sup> <sub>0</sub>	54/31701

\* ALSO FOR CONDUCTOR (ACSR) CODE NAME "TIGER"  
 \*\* FOR CONDUCTOR (ACSR) CODE NAME "DEER"

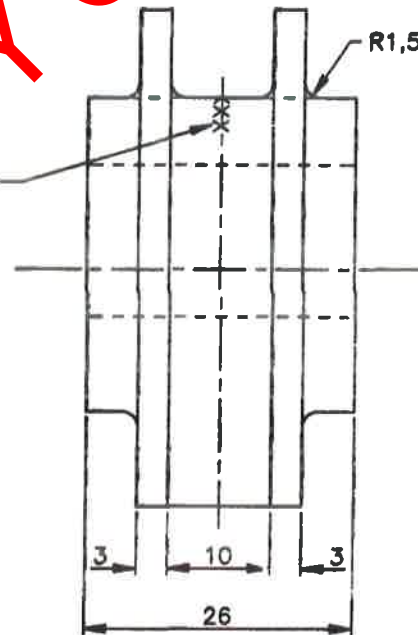

NOTE  
 APPLICABLE CONDUCTOR SIZE 80-, 100-, 160-, 250- OR 530mm<sup>2</sup> TO BE CAST OR PUNCHED IN POSITION SHOWN (3mm CHARACTER HEIGHT).

AMENDMENTS		
NO	NAME	DATE
1	I DE VILLIERS	90-02-14
REDRAWN, INFORMATION ADDED. DO REF: T90/009		
2	I DE VILLIERS	91-03-04
INDICATION OF CONDUCTOR SIZE MOVED. DO REF: T91/010		
3	W BRIGHT	92-06-22
DIMENSION "E" WAS 10,1 ; 11,3 ; 14,8 AND 19. DO REF: T92/027		
4	H A SLIER	98-06-04
DRAWING REVISED AND INFORMATION ADDED. DO REF: T98/024		

"PREVIEW COPY ONLY"

MATERIAL: NYLON 66, PIGMENT: BLACK		
DO REF T90/001	GEN TOL: LIN ± 0,2	ANG ± 0°30'
DRN J VON ABO	CKD J H SWIEGERS	DATE 90-01-29
ENG A VERSTEEG	A VERSTEEG	for CHIEF ENG

**DROPPER CLIP**  
 CLIP-ON TYPE

80-, 100-, 160-, 250- & 530mm<sup>2</sup> CATENARIES

INFRASTRUCTURE  
 (ELECTRICAL)



DIMENSIONS:mm	A3
SCALE 2:1	
DRAWING NC CEE-	
TND-5	
SHEET - OF -	



PR 10503460.

ITEM	DESCRIPTION	QTY	STORES ITEM NO	DRG NO CEE-	AMENDMENTS		
					NO	NAME	DATE
1	CLAMP, ELECTRICAL, HALF DROPPER CLIP WITH THREAD AND SPACER PIN	1		TND-0022 SHT 2	NO		
2	CLAMP, ELECTRICAL, HALF DROPPER CLIP WITHOUT THREAD	1		TND-0022 SHT 3	5		13/02/07
3	SCREW, STAINLESS STEEL, HEX. HEAD, M8 x 30L TO SPECIFICATION AISI GRADE 316	1			ITEM 3 AND 4 WAS M10		
4	WASHER, LOCKING, INTERNAL TOOTH, STAINLESS STEEL, M8 TO SPECIFICATION AISI GRADE 316	1			ECP REF: BBC5700 DO REF: CDO/5261		

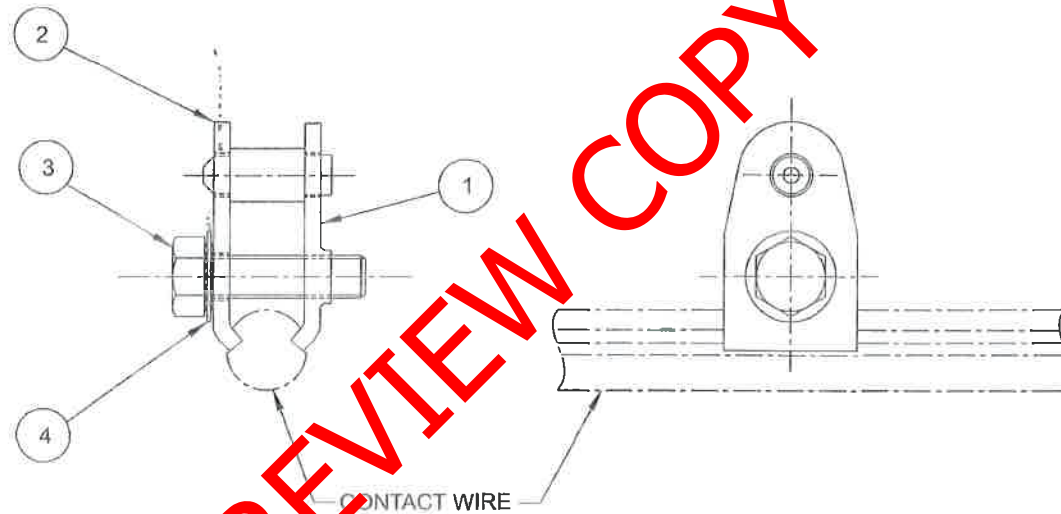

"PREVIEW COPY ONLY"

TABLE (SEE SHEET 5)	
CONTACT WIRE	STORES NO
161mm <sup>2</sup> Cu	54/017312
107mm <sup>2</sup> Cu	54/006787

STORES ITEM NO  
SEE TABLE

DIMENSIONS: mm  
SCALE: 1:1

A3

© COPYRIGHT PROTECTED. PREPARED BY CENTRAL DRAWING OFFICE.

DO REF: N41 / 70	GEN TOL: LIN± - ANG± -
DRN: H F	CKD: H NIEHAUS DATE: 70-05-04
ENG: PIENAAR	PHILLIPS for CHIEF ENG

## CLAMP, ELECTRICAL

DROPPER CLIP, COMPLETE, 161mm<sup>2</sup> / 107mm<sup>2</sup> Cu CONTACT WIRE  
KARL PHISTERER / ARTHUR FLURY SECTION INSULATOR

DRAWING NO CEE-  
**TND - 0022**  
SHEET 1 OF 5

CENTRAL DRAWING OFFICE SPOORNET

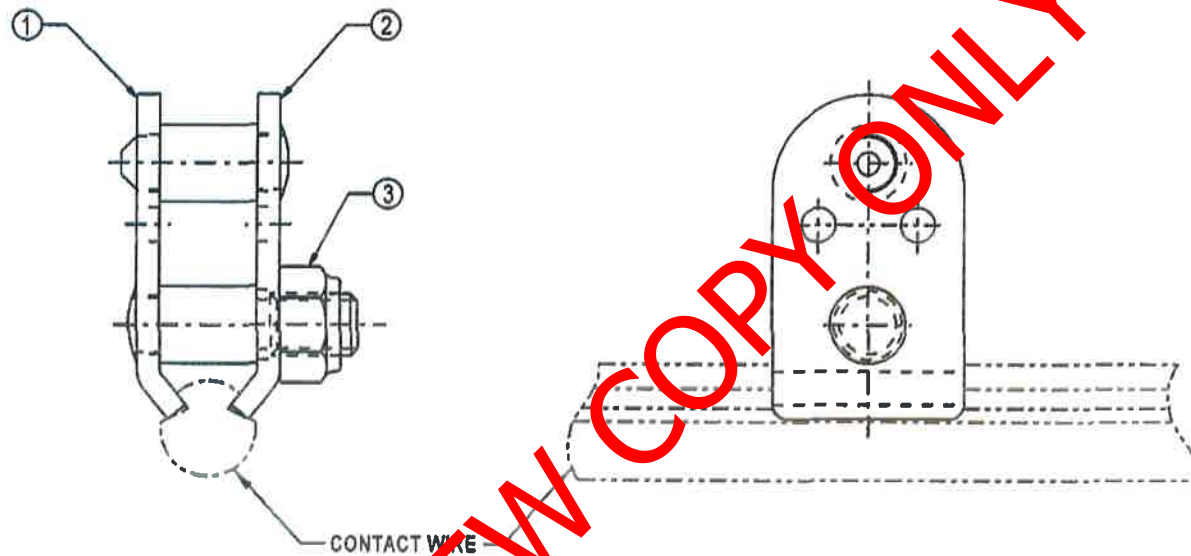

TABLE	
CONTACT WIRE	STORES NO
161mm <sup>2</sup> Cu.	54/17312
107mm <sup>2</sup> Cu.	54/6787

© COPYRIGHT PROTECTED. PREPARED BY CENTRAL DRAWING OFFICE

ITEM NO	DESCRIPTION	QTY	STORES ITEM NO	DRAWING NO
3	NYLOCK NUT, STEEL, HEX. HEAD, M8 TO SPECIFICATION AISI GRADE 316.	1	-	-
2	HALF DROPPER CLIP SUB- ASSEMBLY WITH SPACER PIN	1	-	BBB8334
1	HALF DROPPER CLIP SUB- ASSEMBLY WITH THREADED STUD.	1	-	BBB8333

DIMENSIONS : mm  
 TOLERANCE : LIN ± . ANG ± .  
 MATERIAL :-  
 VERSION INFO :-  
 SCALE : 1 : 1  
 ITEM NO :-

DO REF : CDO/3909  
 ECP REF :-  
 DRAWN : J.R. Anthony  
 DESIGNED :-  
 CHECKED : J.D. van Dyk

DATE: 14/02/2005  
  
 APPROVED  
  
 AUTHORISED

**DROPPER CLIP ASSEMBLY  
 WITH PIN & THREADED STUD**  
 161mm<sup>2</sup> / 107mm<sup>2</sup> Cu.  
**CONTACT WIRE**

**BBB8332**  
 VERSION 1



PR 10503461.

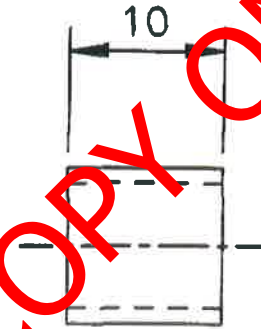
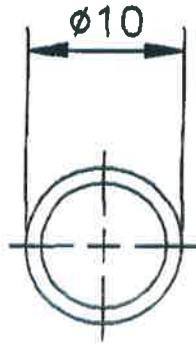

**"PREVIEW COPY ONLY"**

AMENDMENTS

NO	NAME	DATE
6	<del>          </del>	99-10-25

DRG. REINSTATED  
 O.D. WAS  $\phi 13$ .  
 D.O. REF. CDO/298

STORES ITEM NO.  
 54/2790

DIMENSIONS: mm  
 SCALE: 2:1

MATERIAL: COPPER TUBE  $\phi 10$  OD X 10L, 1mm WALL THICKNESS TO SABS 460 TABLE 2 CLASS 3.

DO REF: M26/64 GEN TOL: LIN $\pm$  0.5 ANG $\pm$  —

DRN: F.HEYL CKD: E.JURGENSON DATE: 63-03-27

ENG: D.McCARTHY W.PHILLIPS for CHIEF ENG

ELECTRIFICATION TYPE: GENERAL

**SLEEVE, DROPPER SECURING**

CENTRAL DRAWING  
 OFFICE



DRG NO CEE-  
 TX-79

SHT — OF —

PR 10503462

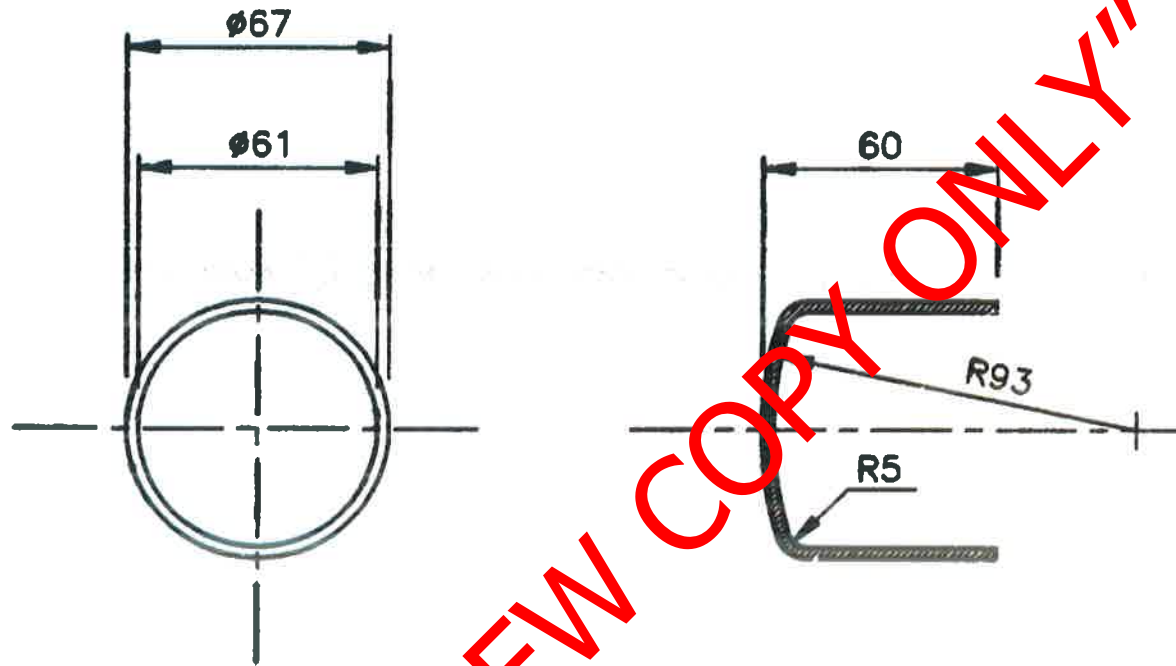

AMENDMENTS		
NO	NAME	DATE
1	JVT	97-04-07

REVISED, DRG NO WAS CEE-TN-186.  
DO REF: T96/001

STORES ITEM NO. \_\_\_\_\_

DIMENSIONS: mm  
SCALE: 1:2

MATERIAL: ITEM NO \_\_\_\_\_, POLYVINYL CHLORIDE (PVC), TYPE TM1(HARD), BLACK, TO BS 6746 TABLE 1

DO REF: T80/65	GEN TOL: LIN± 0,5	ANG± 1°
DRN: T HUMAN	CKD:R McMILLAN	DATE: 80-02-13
ENG: _____	GA WILLIAMS	for CHIEF ENG

**SEALING CAP**  
CANTILEVER STRUT

INFRASTRUCTURE  
(ELECTRICAL)



DRG NO **CEE-TNA-1**  
SHT — OF —

T0001023