



T F R, a division of

TRANSNET SOC LTD

Registration Number 1990/000900/30

[hereinafter referred to as **Transnet**]

**REQUEST FOR QUOTATION [RFQ] No SAZ53257
CUTTING OF OVERGROWN VEGETATION FROM LOOP 10 TO ERTS**

**FOR THE SUPPLY/PROVISION OF CUTTING OF OVERGROWN VEGETATION
FROM LOOP 10 TO ERTS**

FOR DELIVERY TO: T F R Infrastructure Saldanha

ISSUE DATE: 15 October 2014

CLOSING DATE: 28 October 2014

CLOSING TIME: 10:00



RFQ SAZ53257

SCHEDULE OF DOCUMENTS

CUTTING OF OVERGROWN VEGETATION FROM LOOP 10 TO ERTS

Section

1. Notice to Bidders
2. Quotation Form
3. Standard Term and Conditions for the supply of Goods or services to Transnet
4. Vendor Application form
5. Certificate of attendance of RFQ briefing

Part A - Project specifications

Part B - Previous related reference with experience

Part C - Health and safety plan

Part D - Risk and environmental plan

Part E - Working program

General Bid Conditions – Appendix (i)

Standard term and conditions of contract (services) Appendix (ii)

E4E - safety arrangements and procedural compliance with the occupational health and safety act

E7/1 - specification for general work and works on, over, under or adjacent to railway lines



Section 1
NOTICE TO BIDDERS

Quotations which must be completed as indicated in Section 2 of this RFQ are to be submitted as follows:

METHOD: [post and/or courier]
CLOSING VENUE: [see below for closing venue]

Proposals must reach the Secretariat, Acquisition Council before the closing hour on the date shown below, and must be enclosed in a sealed envelope which must have inscribed on the outside:

RFQ No: **SAZ53257**
Description: **CUTTING OF OVERGROWN VEGETATION FROM LOOP 10 TO ERTS**
Closing date and time: **28 October 2014 AT 10:00 Sharp**
Closing address: [Refer to options in Delivery Instructions for RFQ below]

All envelopes must reflect the return address of the respondent on the reverse side.

A. DELIVERY INSTRUCTIONS FOR RFQ

Delivery by hand

If delivered by hand, the envelope is to be deposited in the Transnet tender box which is located at the main entrance of Transnet Park, ROBERT SOBUKWE Road, Bellville, and should be addressed as follows:

THE SECRETARIAT
ACQUISITION COUNCIL
TRANSNET PARK BUILDING
TENDER BOX
ROBERT SOBUKWE ROAD
BELLVILLE 7535

- a) The measurements of the "tender slot" are 400mm wide x 100mm high, and Respondents must please ensure that response documents or files are no larger than the above dimensions. Responses which are too bulky [i.e. more than 100mm thick] must be split into two or more files, and placed in separate envelopes, each such envelope to be addressed as above.

Dispatch by courier

If dispatched by courier, the envelope must be addressed as follows and delivered to the Office of The Secretariat, Acquisition Council and a signature obtained from that Office:

THE SECRETARIAT
TRANSNET ACQUISITION COUNCIL
6TH FLOOR
TRANSNET PARK BUILDING
ROBERT SOBUKWE ROAD
BELLVILLE

Please note that this RFQ closes punctually at **10:00 on 28 October 2014**.



1. If responses are not delivered as stipulated herein, such responses will not be considered and will be treated as "NON-RESPONSIVE" and will be disqualified.
2. No email or facsimile responses will be considered, unless otherwise stated herein.
3. The responses to this RFQ will be opened as soon as practicable after the expiry of the time advertised for receiving them.
4. Transnet shall not, at the opening of responses, disclose to any other company any confidential details pertaining to the Proposals / information received, i.e. pricing, delivery, etc. The names and locations of the Respondents will be divulged to other Respondents upon request.
5. Envelopes must not contain documents relating to any RFQ other than that shown on the envelope.

B. FORMAL RFQ BRIEFING

- i. A compulsory RFQ briefing and Site Meeting will be conducted at the Salkor Building, Saldanha on the **23 October 2014** at **11:00** for a period of \pm 30 minutes. [Respondents to provide own transportation]. Only one of the sites will be visited. Also bring your safety shoes and reflective vest for the site meeting.
- ii. **Respondents failing to attend the compulsory RFQ briefing will be disqualified.**
- iii. The briefing session will start punctually at **11:00** and information will not be repeated for the benefit of Respondents arriving late.

"PREVIEW COPY ONLY"

1 Responses to RFQ

Responses to this RFQ [**Quotations**] must not include documents or reference relating to any other quotation or proposal. Any additional conditions must be embodied in an accompanying letter.

2 Broad-Based Black Economic Empowerment [B-BBEE]

Transnet fully endorses and supports the Government's Broad-Based Black Economic Empowerment Programme and it would therefore prefer to do business with local business enterprises who share these same values. Transnet will accordingly allow a "preference" to companies who provide a valid B-BBEE Verification Certificate. All procurement transactions will be evaluated accordingly.

2.1 B-BBEE Scorecard and Rating

As prescribed in terms of the Preferential Procurement Policy Framework Act (PPPFA), Act 5 of 2000 and its Regulations, Respondents are to note that the following preference point systems are applicable to all bids:

- the 80/20 system for requirements with a Rand value of up to R1 000 000 (all applicable taxes included); and
- the 90/10 system for requirements with a Rand value above R1 000 000 (all applicable taxes included).
- Bidders are to note that if the 80/20 preference point system is stipulated in this RFP and all Bids received exceed R1 000 000.00, the RFP must be cancelled. Similarly, if the 90/10 preference point system is stipulated in this RFP and all Bids received are equal to or below R1 000 000.00, the RFP must be cancelled.

The value of this bid is estimated to exceed R1 000 000 (all applicable taxes included); and therefore the 90/10 system shall be applicable.

When Transnet invites prospective suppliers to submit Proposals for its various expenditure programmes, it requires Respondents to have their B-BBEE status verified in compliance with the Codes of Good Practice issued in terms of the Broad Based Black Economic Empowerment Act No. 53 of 2003.

The Department of Trade and Industry recently revised the Codes of Good Practice on 11 October 2013 [Government Gazette No. 36928]. The Revised Codes will replace the Black Economic Empowerment Codes of Good Practice issued on 9 February 2007. The Revised Codes provide for a one year transitional period starting 11 October 2013. During the transitional period, companies may elect to be measured in terms of the Revised Codes or the 2007 version of the Codes. After the first year of the implementation of the Revised Codes, B-BBEE compliance will be measured in

terms of the Revised Codes without any discretion. Companies which are governed by Sector-specific Codes will be measured in terms of those Sector Codes.

As such, Transnet will accept B-BBEE certificates issued based on the Revised Codes. Transnet will also continue to accept B-BBEE certificates issued in terms of the 2007 version of the Codes provided it was issued before 10 October 2014. Thereafter, Transnet will only accept B-BBEE certificates issued based on the Revised Codes.

Respondents are required to complete Annexure A [the B-BBEE Preference Point Claim Form] and submit it together with proof of their B-BBEE Status as stipulated in the Claim Form in order to obtain preference points for their B-BBEE status.

Note: Failure to submit a valid and original B-BBEE certificate or a certified copy thereof at the Closing Date of this RFQ will result in a score of zero being allocated for B-BBEE.

[Refer clause 18 below for Returnable Documents required]

2.2 COMMUNICATION

Respondents are warned that a response will be liable for disqualification should any attempt be made by a Respondent either directly or indirectly to canvass any officer or employee of Transnet in respect of this RFQ between the closing date and the date of the award of the business.

A Respondent may, however, before the closing date and time, direct any written enquiries relating to the RFQ to the following Transnet employee:

Name: Cobus Carstens Email: cobus.carstens@transnet.net

Respondents may also, at any time after the closing date of the RFQ, communicate with the Secretariat of the Transnet Acquisition Council on any matter relating to its RFQ response:

Telephone 021 940 3816 Email: carol.swan@transnet.net

3 Tax Clearance

The Respondent's original and valid Tax Clearance Certificate must accompany the Quotation. Note that no business shall be awarded to any Respondent whose tax matters have not been declared by SARS to be in order.

4 VAT Registration

The valid VAT registration number must be stated here: _____ *[if applicable]*.

5 Legal Compliance

The successful Respondent shall be in full and complete compliance with any and all applicable national and local laws and regulations.

6 Changes to Quotations

Changes by the Respondent to its submission will not be considered after the closing date and time.

7 Pricing

All prices must be quoted in South African Rand on a fixed price basis, excluding VAT.

8 Prices Subject to Confirmation

Prices quoted which are subject to confirmation will not be considered.

9 Negotiations

Transnet reserves the right to undertake post-tender negotiations with selected Respondents or any number of shortlisted Respondents.

10 Binding Offer

Any Quotation furnished pursuant to this Request shall be deemed to be an offer. Any exceptions to this statement must be clearly and specifically indicated.

11 Disclaimers

Transnet is not committed to any course of action as a result of its issuance of this RFQ and/or its receipt of a Quotation in response to it. Please note that Transnet reserves the right to:

- modify the RFQ's goods / service(s) and request Respondents to respond on any changes;
- reject any Quotation which does not conform to instructions and specifications which are detailed herein;
- disqualify Quotations submitted after the stated submission deadline;
- not necessarily accept the lowest priced Quotation;
- reject all Quotations, if it so decides;
- place an order in connection with this Quotation at any time after the RFQ's closing date;
- award only a portion of the proposed goods / service/s which are reflected in the scope of this RFQ;
- split the award of the order/s between more than one Supplier/Service Provider; or
- make no award at all.

Transnet reserves the right to award business to the highest scoring bidder/s unless objective criteria justify the award to another bidder.

12 Transnet's supplier integrity pact

Transnet's Integrity Pact requires a commitment from suppliers and Transnet that they will not engage in any corrupt and fraudulent practices, anti-competitive practices; and act in bad faith towards each other. The Integrity Pact also serves to communicate Transnet's Gift Policy as well as the remedies available to Transnet where a Respondent contravenes any provision of the Integrity Pact.

Respondents are required to familiarise themselves with the contents of the Integrity Pact which is available on the Transnet Internet site [www.transnet.net/Tenders/Pages/default.aspx] or on request. Furthermore, Respondents are required to certify that they have acquainted themselves with all the documentation comprising the Transnet Integrity Pact and that they fully comply with all the terms and conditions stipulated in the Transnet Supplier Integrity Pact as follows:

YES	
------------	--

NO	
-----------	--

Should a Respondent need to declare previous transgressions or a serious breach of law in the preceding 5 years as required by Annexure A to the Integrity Pact, such declaration must accompany the Respondent's bid submission.

13 Evaluation Criteria

Transnet will utilise the following criteria [not necessarily in this order] in choosing a Supplier/Service Provider, if so required:

Criterion/Criteria	Explanation
Administrative responsiveness	Completeness of response and returnable documents
Substantive responsiveness	Prequalification criteria, if any, must be met and whether the Bid materially complies with the scope and/or specification given. Pest control certificate.
Functionality Threshold	As prescribed in terms of the Preferential Procurement Policy Framework Act (PPPFA), Act 5 of 2000 and its Regulations, Respondents are to note that functionality is included as threshold with a prescribed percentage threshold of 60%. The minimum threshold of 60% must be met or exceeded for a Bidder's proposal to progress to the next stage of evaluation.
Final weighted evaluation based on 90/10 preference point system as indicated in paragraph 2	<ul style="list-style-type: none"> Pricing and price basis [10m] - whilst not the sole factor for consideration, competitive pricing and overall level of unconditional discounts¹ will be critical B-BBEE status of company - Preference points will be awarded to a bidder for attaining the B-BBEE status level of contribution in accordance with the table indicated below.

Preference points will be awarded to a bidder for attaining the B-BBEE status level of contribution in accordance with the table below:

B-BBEE Status Level of Contributor	Number of points (90/10 system)
1	10
2	9
3	8
4	5
5	4
6	3
7	2
8	1
Non-compliant contributor	0

¹ Only unconditional discounts will be taken into account during evaluation. A discount which has been offered conditionally will, despite not being taken into account for evaluation purposes, be implemented when payment is effected.

Technical Evaluation Criteria

The Technical criteria and maximum score in respect of each of the criteria are as follows:

Technical criteria	Sub-criteria Maximum number of Points	Checklist for submission Yes / No
Health and Safety Plan	25%	
Risk and Environment Plan	25%	
Previous Related Experience with references	30%	
Working Programme	20%	
Maximum possible score for quality (Ms)	100	

The minimum Threshold for technical criteria is 60%.

The minimum threshold of 60% must be met or exceeded for a Bidder's proposal to progress to the next stage of evaluation.

NB: Kindly ensure that you submit with your proposal all the required documentation for the technical criteria mentioned above.

14 Validity Period

Transnet desires a validity period of 60 [sixty] days from the closing date of this RFQ.

This RFQ is valid until _____.

15 Banking Details

BANK: _____

BRANCH NAME / CODE: _____

ACCOUNT HOLDER: _____

ACCOUNT NUMBER: _____

16 Company Registration

Registration number of company / C.C. _____

Registered name of company / C.C. _____

17 Disclosure of Prices Quoted

Respondents must indicate here whether Transnet may disclose their quoted prices and conditions to other Respondents:

YES NO

18 Returnable Documents

Returnable Documents means all the documents, Sections and Annexures, as listed in the tables below.

- a) Respondents are required to submit with their Quotations the **mandatory Returnable Documents**, as detailed below.

Failure to provide all these Returnable Documents at the Closing Date and time of this RFQ will result in a Respondent's disqualification. Respondents are therefore urged to ensure that all these Documents are returned with their Quotations.

All sections, as indicated in the footer of each page, must be signed, stamped and dated by the Respondent. Please confirm submission of these mandatory Returnable Documents by so indicating [Yes or No] in the table below:

Mandatory Returnable Documents	Submitted [Yes or No]
SECTION 2 : Quotation Form	
Pest Control Certificate	
Part B : Previous related experience with references	
Part C : Health and safety plan	
Part D : Risk and Safety plan	
Part E : Working programme	

- b) In addition to the requirements of section (a) above, Respondents are further required to submit with their Quotations the following **essential Returnable Documents** as detailed below.

Failure to provide all these Returnable Documents may result in a Respondent's disqualification. Respondents are therefore urged to ensure that all these documents are returned with their Quotations.

All Sections, as indicated in the footer of each page, must be signed, stamped and dated by the Respondent. Please confirm submission of these essential Returnable Documents by so indicating [Yes or No] in the table below:

Essential Returnable Documents	Submitted [Yes or No]
SECTION 1 : Notice to Bidders	
<ul style="list-style-type: none"> - Valid and original B-BBEE Verification Certificate or certified copy thereof [Large Enterprises and QSEs] <p>Note: failure to provide a valid B-BBEE Verification Certificate at the closing date and time of the RFQ will result in an automatic score of zero for preference</p>	
<ul style="list-style-type: none"> - Valid and original B-BBEE certificate/sworn affidavit or certified copy thereof from auditor, accounting officer or SANAS accredited Verification Agency [EMEs] <p>Note: failure to provide a valid B-BBEE Verification Certificate at the closing date and time of the RFQ will result in an automatic score of zero being allocated for preference</p>	
<ul style="list-style-type: none"> - In the case of Joint Ventures, a copy of the Joint Venture Agreement or written confirmation of the intention to enter into a Joint Venture Agreement 	
<ul style="list-style-type: none"> - Original valid Tax Clearance Certificate [Consortia / Joint Ventures must submit a separate Tax Clearance Certificate for each party] 	
<ul style="list-style-type: none"> - SECTION 3 : Standard Terms and Conditions of Contract for the Supply of Goods or Services to Transnet 	
SECTION 4 : Vendor Application Form	
<ul style="list-style-type: none"> - Original cancelled cheque or bank verification of banking details 	
<ul style="list-style-type: none"> - Certified copies of IDs of shareholder/directors/members [as applicable] 	
<ul style="list-style-type: none"> - Certified copies of the relevant company registration documents from Companies and Intellectual Property Commission (CIPC) 	
<ul style="list-style-type: none"> - Certified copies of the company's shareholding/director's portfolio 	
<ul style="list-style-type: none"> - Entity's letterhead 	
<ul style="list-style-type: none"> - Certified copy of VAT Registration Certificate [RSA entities only] 	
<ul style="list-style-type: none"> - Certified copy of valid Company Registration Certificate [if applicable] 	
<ul style="list-style-type: none"> - A signed letter from Respondent's auditor or accountant confirming most recent annual turnover figures 	
<ul style="list-style-type: none"> - Financial Statements signed by your Accounting Officer or Audited Financial Statements for previous 3 years 	
<ul style="list-style-type: none"> - Letter of Good Standing 	

**Section 2
QUOTATION FORM**

I/We _____
hereby offer to supply the goods/services at the prices quoted in the Price Schedule below, in accordance with the conditions related thereto.

I/We agree to be bound by those terms and conditions in:

- the Standard Terms and Conditions for the Supply of Goods or Services to Transnet [Section 3 hereof]; and
- any other standard or special conditions mentioned and/or embodied in this Request for Quotation.

I/We accept that unless Transnet should otherwise decide and so inform me/us, this Quotation [and, if any, its covering letter and any subsequent exchange of correspondence], together with Transnet's acceptance thereof shall constitute a binding contract between Transnet and me/us.

I/We further agree that if, after I/we have been notified of the acceptance of my/our Quotation, I/we fail to deliver the said goods/service/s within the delivery lead-time quoted, Transnet may, without prejudice to any other legal remedy which it may have, cancel the order and recover from me/us any expenses incurred by Transnet in calling for Quotations afresh and/or having to accept any less favourable offer.

Price Schedule

I/We quote as follows for the goods required, on a "delivered nominated destination" basis, excluding VAT:

Work lots	Kilometre Distance (Km)	Rate / Work lot (1Km x 4m width)
430	430	
Cut, Spray and remove woody vegetation		
TOTAL (excluding VAT)		

A work lot is a subdivision of any area on which the Contractor shall cut out vegetation. The work lots are calculated from the required width of 4 meters, times the distance.

Tenders must provide rate per kilometer on the price schedule below

1 work lot = 4 m x kilometer distance

Delivery Lead-Time from date of purchase order : _____ [days/weeks]

Respondent's Signature

Date & Company Stamp

Notes to pricing :

- a) All Prices must be quoted in South African Rand, exclusive of VAT
- b) To facilitate like-for-like comparison bidders must submit pricing strictly in accordance with this price schedule and not utilise a different format. Deviation from this pricing schedule could result in a bid being disqualified.
- c) Please note that should you have offered a discounted price(s), Transnet will only consider such price discount(s) in the final evaluation stage if offered on an unconditional basis.

"PREVIEW COPY ONLY"

Respondent's Signature

Date & Company Stamp

Section 3

STANDARD TERMS AND CONDITIONS FOR THE SUPPLY OF GOODS OR SERVICES TO TRANSNET

A Supplier/Service Provider shall be obliged to adhere to the Standard Terms and Conditions for the Supply of Goods and Services to Transnet as expressed hereunder. Should the Respondent find any condition(s) unacceptable, it should indicate which condition(s) is/are unacceptable and offer an alternative(s). A Quotation submitted by a Respondent will be subjected to review and acceptance or rejection of its proposed contractual terms and conditions by Transnet's Legal Counsel, prior to consideration for an award of business.

1 SOLE AGREEMENT

Unless otherwise agreed in writing, these terms [Terms and each Term] and Transnet's purchase order(s) [Order or Orders] represent the only conditions upon which Transnet SOC Ltd [Transnet] procures goods [the Goods] or services [the Services] specified in the Order from the person to whom the Order is addressed [the Supplier/Service Provider]. Transnet does not accept any other conditions which the Supplier/Service Provider may specify, unless otherwise agreed to by Transnet in writing. In the event of any inconsistency between these Terms and any Order, these Terms shall take precedence.

2 CONFORMITY WITH ORDER

Goods/Services shall conform strictly with the Order. The Supplier/Service Provider shall not vary the quantities specified and/or the specification, if any, stipulated in the Order, without the prior written consent of Transnet. The Supplier/Service Provider warrants that the Goods/Services shall be fit for their purpose and of satisfactory quality.

3 DELIVERY AND TITLE

3.1 The delivery dates and addresses are those in the Order. Time shall be of the essence in respect of the Supplier's/Service Provider's obligations under the Order.

3.2 The Supplier/Service Provider will not be excused for delay in delivery or performance except due to circumstances outside its control and then only subject to the Supplier/Service Provider having notified Transnet in writing on becoming aware of such circumstances. Transnet may terminate an Order, in whole or in part, without incurring any liability to the Supplier/Service Provider if such a delay becomes, in Transnet's absolute opinion, significant.

3.3 If on delivery, the Goods/Services do not conform to the Order, Transnet may reject the Goods/Services and the Supplier/Service Provider shall promptly rectify any defects or in Transnet's opinion, supply appropriate replacement Goods/Services at the Supplier's/Service Provider's expense within the specified delivery times, without any liability due by Transnet.

4 PRICE AND PAYMENT

4.1 Prices specified in an Order cannot be increased. Payment for the Goods/Services shall be made by Transnet against an original undisputed invoice(s) [a Tax Invoice], supporting documentation and month-end statement from the Supplier/Service Provider. Tax Invoices plus supporting documentation shall be posted to the address shown in the Order.

4.2 Payment of the Supplier's/Service Provider's valid Tax Invoice(s) will be made by Transnet in the South African currency and on the terms stated in the Order, the standard payment terms being 30 [thirty] days from date of receipt by Transnet of a month-end statement, unless otherwise agreed to in writing. Transnet shall arrange for payment of such Tax Invoices and any pre-authorised additional expenses incurred, provided that the authorised expenses are supported by acceptable documentary proof of expenditure incurred [where this is available]. Any amounts due in terms of these Terms shall be paid to the Supplier/Service Provider, taking into account any deduction or set-off and bank charges.

5 PROPRIETARY RIGHTS LIABILITY

If any allegations should be made or any claim asserted against Transnet that ownership of, or any act or omission by Transnet in relation to Goods/Services or any written material provided to Transnet relating to any Goods/Services or pursuant to an Order being a violation or infringement of any third party's contractual, industrial, commercial or intellectual property rights including but not limited to any patent, registered design, design right, trade mark, copyright or service mark or any application thereof, the Supplier/Service Provider hereby indemnifies Transnet against and holds it harmless from any and all losses, liabilities, costs, claims, damages and expenses [including any legal fees] arising directly or indirectly from such allegation or claim provided that this indemnity shall not apply where the allegation or claim arises solely as a result of the Supplier/Service Provider following a design or process originated and furnished by Transnet. The Supplier/Service Provider shall either

- a) procure for Transnet the right to continue using the infringing Goods; or
- b) modify or replace the Goods/Services so that they become non-infringing,

provided that in both cases the Goods/Services shall continue to meet Transnet's requirements and any specifications stipulated in the Order. Should neither option be possible, the Supplier/Service Provider may remove, with Transnet's prior written consent, such Goods/Services and will pay to Transnet a sum equivalent to the purchase price. If Transnet refuses to give such consent, the Supplier/Service Provider shall have no liability in respect of any continued use of the infringing Goods/Services after Supplier's/Service Provider's prior written request to remove the same.

6 PROPRIETARY INFORMATION

All information which Transnet has divulged or may divulge to the Supplier/Service Provider and any information relating to Transnet's business which may have come into the Supplier's/Service Provider's possession whilst carrying out an Order, and the existence of the Order, shall be treated by the Supplier/Service Provider as confidential information and shall not, without Transnet's prior written consent, be disclosed to any third party, or be used or copied for any purposes other than to perform the Order. This clause does not apply to information which is public knowledge or available from other sources other than by breach of this Term. Upon request by Transnet, the Supplier/Service Provider shall return all materials issued pursuant to the Order and, pending this, shall protect Transnet's rights in any such materials. Such confidential information shall at all material times be the property of Transnet.

7 PUBLICITY

The Supplier/Service Provider shall not name Transnet or use its trademarks, service marks [whether registered or not] or Goods in connection with any publicity without Transnet's prior written consent.

8 TERMINATION OF ORDER

- 8.1 Transnet may cancel an Order in whole or in part at any time upon at least 7 [seven] days' written notice to the Supplier/Service Provider, or when there is a change in control of the Supplier/Service Provider or the Supplier/Service Provider commits any serious breach or any repeated or continued material breach of its obligations under these Terms and/or Order or shall have been guilty of conduct tending to bring itself into disrepute, on written notice to the Supplier/Service Provider when such work on the Order shall stop.
- 8.2 Transnet shall pay the Supplier/Service Provider a fair and reasonable price for justified work in progress, where such price reflects only those costs not otherwise recoverable by the Supplier/Service Provider, at the time of termination, and the Supplier/Service Provider shall give Transnet full assistance to check the extent of such work in progress. Payment of such price shall be in full and final satisfaction of any claims arising out of such termination and upon such payment the Supplier/Service Provider shall deliver to Transnet all work, including any materials, completed or in progress. The sum payable to the Supplier/Service Provider under this clause will not in any event exceed the total amount that would have been payable to the Supplier/Service Provider had the Order not been terminated.
- 8.3 In the event of termination the Supplier/Service Provider must submit all claims within 2 [two] months of termination after which time claims will only be met in what Transnet considers exceptional circumstances.
- 8.4 If the Goods or Services are not provided in accordance with an Order, the Order shall be deemed terminated and the Supplier/Service Provider shall compensate Transnet for any costs incurred in obtaining substitute Goods or any damage caused due to the failure or delay in the delivery.

9 ACCESS

The Supplier/Service Provider shall be liable for the acts, omissions and defaults of its personnel or agents who, for the purposes of the Order, shall be treated as if they are the Supplier's/Service Provider's employees. The Supplier/Service Provider shall ensure that any such personnel or agents, whilst on Transnet's premises, shall comply with Transnet's health and safety, security and system security rules and procedures as and where required.

10 WARRANTY

The Supplier/Service Provider warrants that it is competent to supply the Goods/Services in accordance with these Terms to the reasonable satisfaction of Transnet and that all Goods/Services delivered under the Order: (a) conform and comply in all relevant legislation, standards, directives and orders related to [inter alia] the Goods/Services in force at the time of delivery, and to any specifications referred to in the Order; (b) will not cause any deterioration in the functionality of any Transnet equipment; and (c) do not infringe any third party rights of any kind. The Supplier/Service Provider hereby indemnifies Transnet against all losses, liabilities, costs, claims, damages, expenses and awards of any kinds incurred or made against Transnet in connection with any breach of this warranty.

11 INSOLVENCY

If the Supplier/Service Provider shall have a receiver, manager, administrator, liquidator or like person appointed over all or any part of its assets or if the Supplier/Service Provider compounds with its creditors or passes a resolution for the winding up or administration of the Supplier/Service Provider, Transnet is at liberty to terminate the Order or Orders forthwith, or at its option, to seek performance by any such appointed person.

12 ASSIGNMENT

The Supplier/Service Provider shall not assign its obligations under an Order without Transnet's prior written consent, which consent shall not be unreasonably withheld or delayed.

13 NOTICES

Notices under these Terms shall be delivered by hand to the relevant addresses of the parties in the Order or may be served by facsimile or by email, in which event notices shall be deemed served on acknowledgement of receipt by the recipient.

14 LAW

Orders shall be governed by and interpreted in accordance with South African law and any disputes arising herein shall be subject to South African arbitration under the rules of the Arbitration Foundation of South Africa, which rules are deemed incorporated by reference in this clause. The reference to arbitration shall not prevent Transnet referring the matter to any South African courts, having jurisdiction, to which the Supplier/Service Provider hereby irrevocably submits but without prejudice to Transnet's right to take proceedings against the Supplier/Service Provider in other jurisdictions and/or obtaining interim relief on an urgent basis from a court of competent jurisdiction pending the decision in other courts or from instituting in any court of competent jurisdiction any proceedings for an interdict or any other injunctive relief. If the Supplier/Service Provider does not have a registered office in the South Africa it will at all times maintain an agent for service of process in South Africa and shall give Transnet the name and address of such agent as such may be amended in writing, from time to time.

15 GENERAL

Completion or termination of an Order shall be without prejudice to any Term herein which by its nature would be deemed to continue after completion or termination. Headings are included herein for convenience only. If any Term herein be held illegal or unenforceable, the validity or enforceability of the remaining Terms shall not be affected. No failure or delay by Transnet to enforce any rights under these Terms will operate as a waiver thereof by Transnet. All rights and remedies available to either party under these Terms shall be in addition to, not to the exclusion of, rights otherwise available at law.

16 COUNTERPARTS

These Terms and conditions may be signed in any number of counterparts, all of which taken together shall constitute one and the same instrument. Any party may enter into this agreement by signing any such counterpart.

By signing this RFQ document, the Respondent is deemed to acknowledge that he/she has made himself/herself thoroughly familiar with all the conditions governing this RFQ, including those contained in any printed form stated to form part hereof and Transnet SOC Ltd will recognise no claim for relief based on an allegation that the Respondent overlooked any such condition or failed to properly take it into account for the purpose of calculating quoted prices or otherwise.

SIGNED at _____ on this ____ day of _____ 20__

.....
SIGNATURE OF RESPONDENT'S AUTHORISED REPRESENTATIVE

NAME: _____

DESIGNATION: _____

REGISTERED NAME OF COMPANY: _____

PHYSICAL ADDRESS:

Respondent's contact person: *[Please complete]*

Name	:	
Designation	:	
Telephone	:	
Cell Phone	:	
Facsimile	:	
Email	:	
Website	:	



**Transnet urges its clients, suppliers and the general public
to report any fraud or corruption to
TIP-OFFS ANONYMOUS : 0800 003 056**

Section 4
VENDOR APPLICATION FORM

Respondents are to furnish the following documentation and complete the Vendor Application Form below:

1. **Original** cancelled cheque **OR** letter from the Respondent's bank verifying banking details **[with bank stamp]**
2. **Certified** copy of Identity Document(s) of Shareholders/Directors/Members [where applicable]
3. **Certified copies** of the relevant company registration documents from Companies and Intellectual Property Commission (CIPC)
4. **Certified copies** of the company's shareholding/director's portfolio
5. A letter on the company's letterhead confirm physical and postal addresses
6. **Original** valid SARS Tax Clearance Certificate
7. **Certified copy** of VAT Registration Certificate
8. **A valid and original** B-BBEE Verification Certificate / sworn affidavit **or certified copy** thereof meeting the requirements for B-BBEE compliance as per the B-BBEE Codes of Good Practice
9. **Certified copy** of valid Company Registration Certificate [if applicable]

Vendor Application Form

Company trading name						
Company registered name						
Company Registration Number or ID Number if a Sole Proprietor						
Form of entity [✓]	CC	Trust	Pty Ltd	Limited	Partnership	Sole Proprietor
VAT number [if registered]						
Company telephone number						
Company fax number						
Company email address						
Company website address						
Bank name			Branch & Branch code			
Account holder			Bank account number			

Respondent's Signature

Date & Company Stamp

Postal address Code

Physical Address Code

Contact person

Designation

Telephone

Email

Annual turnover range [last financial year] < R5 m R5 - 35 m > R35 m

Does your company provide Products Services Both

Area of delivery National Provincial Local

Is your company a public or private entity Public Private

Does your company have a Tax Directive or IRP30 Certificate Yes No

Main product or services [e.g. Stationery/Consulting]

Complete B-BBEE Ownership Details:

% Black ownership % Black women ownership % Disabled Black ownership % Youth ownership

Does your entity have a B-BBEE certificate Yes No

What is your B-BBEE status [Level 1 to 9 / Unknown]

How many personnel does the entity employ Permanent Part time

If you are an existing vendor with Transnet please complete the following:

Transnet contact person

Contact number

Transnet Operating Division

Duly authorised to sign for and on behalf of Company / Organisation:

Name	<input type="text"/>	Designation	<input type="text"/>
Signature	<input type="text"/>	Date	<input type="text"/>

Section 5

CERTIFICATE OF ATTENDANCE OF RFQ BRIEFING – RFQ SAZ53257

It is hereby certified that –

1. _____

2. _____

Representative(s) of _____ [name of entity]

attended the RFQ briefing in respect of the proposed Services to be rendered in terms of this RFQ on

_____ 20____

TRANSNET'S REPRESENTATIVE

RESPONDENT'S REPRESENTATIVE

DATE _____

DATE _____

EMAIL _____

"PREVIEW COPY ONLY"

TRANSNET



Part A

PROJECT SPECIFICATION

SAZ53257

**CUTTING OF VEGETATION FROM LOOP 10 TO ERTS FROM KM 443 to KM 861
[Total distance = 430km] ON TRANSNET PROPERTY CONTROLLED BY THE
DEPOT ENGINEER: SALDANHA = (172 Hectare)**

PART A : GENERAL

PART B : TECHNICAL SPECIFICATION

Spec.SAZ53257b

Cutting of overgrown Vegetation
Version 1: 2014

CONTENTS

PART A: GENERAL3

A.1. SCOPE OF WORK.....3

A.2. INTERPRETATIONS3

 A.2.1. SUPPORTING SPECIFICATIONS3

 A.2.2. GENERIC SPECIFICATIONS:3

A.3. SUFFICIENCY OF TENDER.....3

A.4. DURATION OF CONTRACT4

A. 5. TO BE PROVIDED BY TRANSNET FREIGHT RAIL.....4

A.6. TO BE PROVIDED BY CONTRACTOR.....4

A.7. CONTRACT ADJUSTMENT FORMULA4

A.8. MANAGEMENT OF WORKS4

 A.8.1 SITE MEETINGS.....4

 A.8.2 PROGRAM OF WORK4

 A.8.3 PERFORMANCE MONITORING AND EVALUATION / INSPECTIONS.....5

A.9. MEASUREMENT AND PAYMENT5

A.10. HEALTH AND SAFETY5

PART B: TECHNICAL SPECIFICATION7

B.1 SCOPE7

B.2 HEIGHT OF VEGETATION7

B.3 CLEARING OF VEGETATION STRIP7

"PREVIEW COPY ONLY"

PART A: GENERAL

A.1. SCOPE OF WORK

This contract covers the **cutting** of woody vegetation in the rail reserve of Transnet Freight Rail, in the geographical area controlled by the Depot Engineer of the Saldanha Iron Ore line.

Provision should be made for a maintenance period after completion of the initial phase of the project, after which the final payment of 20 % of the tendered rate will be released, in accordance with the achieved results and schedule

The contractor shall obtain his/her own information regarding species occurrence and extent of vegetation in the area and topography where clearing of vegetation is to be provided in order to comply with the required standards

A.2. INTERPRETATIONS

A.2.1. SUPPORTING SPECIFICATIONS

Where this specification is required for a project, the following specifications shall, inter alia, form part of the Contract Document:

A.2.2. GENERIC SPECIFICATIONS:

The following Transnet Generic Specifications will be applicable to this contract:

- The latest E4E. Safety arrangements and procedural compliance with the Occupational Health and Safety Act, Act 85 of 1993 and regulations.
- The latest E7/1 (July 1998); Specifications for works on, over, under or adjacent to railway lines and near high voltage equipment.

A.2.3 DEFINITION

Project Manager: The person appointed by Transnet from time to time to administer the Contract according to the powers and rights held by and obligations placed upon him in terms of the contract.

Project Manager's Deputy / Technical Officer / Supervisor: Any person appointed by Transnet from time to time to administer the contractor's performance and execution of the Works according to the powers and rights held by and obligations placed upon him in terms of the contract.

A.3. SUFFICIENCY OF TENDER

The awarded tenderer should adhere and meet the requirements of the Agriculture Remedies and Stocks Remedies Act, 1047 (Act no.36 of 1947) as set by the Department of Agriculture and Fisheries.

A.4. DURATION OF CONTRACT

The contract provides for the work (phase1) to be completed within three months. Retention period will be allowed for as per schedule, in addition to the above.

A. 5. TO BE PROVIDED BY TRANSNET FREIGHT RAIL

Inspection of the areas of work by rail road inspection trolley may be arranged with the Technical Officer, but will have to coincide with normal track inspection carried out by the inspection/technical staff of the Depot. The Technical officer shall be given timeous notice (4 calendar weeks) of the Contractor's intention to inspect.

A.6. TO BE PROVIDED BY CONTRACTOR

In addition to all labour, material, plant, equipment and incidental needs to complete the work, the contractor shall provide all accommodation and toilet facilities for his/her employees

The contractor shall provide at his/her own cost security measures he/she may deem necessary for safe and effective execution of the work within the contract area

The contractor shall appoint at each work site a person whose sole task shall be to be on the lookout (**protection Flagman**) for approaching rail traffic. This employee shall operate an audible warning device to continuously warn all people on the work site of approaching rail traffic. The personnel of the contractor shall at all times while on Transnet Freight Rail property and during vegetation cutting operation, wear applicable PPE. Reflective safety vest must be yellow in color. The personnel must be trained and certified by Transnet Freight Rail

The contractor or his permanent employee must be a registered Pest Control Officer P.C.O. Proof of registration shall be required. Invoices should be accompanied by report from P.C.O to confirm which species was controlled and name of herbicide used per specie and dosage applied.

A.7. CONTRACT ADJUSTMENT FORMULA

This contract will not be subjected to Price adjustment and /or Escalation

A.8. MANAGEMENT OF WORKS

A.8.1 SITE MEETINGS

The Contractor shall attend site meetings when required. These meetings will be held under the chairmanship of the Project Manager. These meetings will be conducted to monitor progress and discuss contractual issues when required. A register will be kept of attendance and a minute of the proceedings will be recorded and distributed afterwards. When sub-contractors are required to attend, the Contractor shall ensure their attendance.

A.8.2 PROGRAM OF WORK

- The Contractor shall undertake the planning and programming of the entire work operation with the Project Manager for approval.

- The programme shall be based on the quantities and numbers of sections shown in the Price Schedule, at Section 2.
- The programme should allow any prioritization of work schedule that may be requested by Project Manager.

A.8.3 PERFORMANCE MONITORING AND EVALUATION / INSPECTIONS

The Contractor shall at all times be responsible for supervision of the work and for follow-up inspections to monitor the successful cutting out of vegetation over areas of completed application. He/she shall immediately take appropriate remedial action in areas where the specified standards of cutting out are not achieved.

The Project Manager or Technical officer shall at any time during the project, conduct inspections of the Contractor's performance methods and procedure.

A.9. MEASUREMENT AND PAYMENT

Payment will only commence during the execution phase of the Works and will be based on the number of work-lots successfully completed

No payment will be made for rejected work-lots where control achieved does not meet the standards of control specified.

After completion of phase one of the project, the Technical officer or his deputy and the Contractor will measure the work performed. The Contractor will thereafter receive payment of the rates tendered for all of the completed work.

Second and final payment (20%) will be made for work lots approved after three months growing season has lapsed. The months of May, June and July will be considered as "non-growing" season.

A.10. HEALTH AND SAFETY

The Contractor shall at all-time comply with safety rules, regulations and legislation, as well as Transport for London (TfL) Safety Guidelines for Infrastructure (Latest Edition).

The Contractor shall at all times comply with the Basic Conditions of Employment Act as well as any other relevant labour legislation.

The Contractor must conduct his own formal risk assessment to identify all risks. The Contractor is to clearly indicate in his tender submission the processes and procedures he intends implementing to mitigate the total of all these risks: e.g.

- Working with equipment
- live OHTE
- Executing work on one line while a normal train Project is running on adjacent line/s
- Sanitation and refuse disposal as a threat to the environment.

The Contractor shall be responsible to ensure the use of only technically competent trained staff on all types of work.

The Contractor shall ensure that all workers are fit for duty and are appropriately equipped and wearing Personal Protective Equipment (PPE) and that Safety Talks are conducted and noted in the Site Diary before the start of every shift.

The Contractor shall be responsible to ensure that his/her staff go through the **Transnet Freight Rail Safety Induction** and ensure that they are always competently trained with regards to Electrical Awareness Training.

The Contractor shall also be responsible to ensure that contract managers in charge of sites are always competently trained (knowledgeable) with regards to working near or adjacent to railway line in accordance to the Transnet Freight rail regulation in clause **A.2.2**

Non-compliance with safety requirements will result in an immediate suspension of work without payment.

The following training shall be arranged for the following Contractor's staff:

Course	Objective	Duration & trainer	Grade to attend
Awareness (Safety Induction)	To inform all Contractors staff working near a machine and on the line on electrified sections of the dangerous situations of high voltage OLE	Two hour on-the-job lecture and training. Accredited Electrical trainer / Depot's Electrical Supervisor	<ul style="list-style-type: none"> All workers and staff working on the contract

A.11. ENVIRONMENTAL

The contractor shall ensure due regard to indigenous vegetation in accordance to all Environmental legislation, The National Environmental Management Act, 107/1998, The Environmental Conservation Act, 73/1989, the National Water Act 36/1998 and all other applicable legislations

The contractor shall institute and maintain procedures for the safe disposal of all substances and residual materials originating from the execution of the works.

The Contractor shall ensure that his/her employees at all times exercise care and consideration for the fauna and flora.

Private property around the allocated sites must be respected. Dumping or polluting of any kind will not be permitted.

PART B: TECHNICAL SPECIFICATION

B.1 SCOPE

The scope of the work consists of vegetation maintenance on both sides of the railway line;

1. Two meters (2m) **either side of the track formation**, longitudinally along the railway line. Track formation (= a six meter swath) is calculated three meters either side of the center of the track.

A minimum clearance of **2m longitudinal along the end of the track formation** should be **free of woody vegetation**.

2. No fences will be damaged during the process of work

B.2 VEGETATION CUTTING

Minimum height allowed after cutting is **20 mm**.

No vegetation will be pruned in order to reach the required two meter cleared area.

Woody species extending into the cleared area will be felled, and cut stumps treated with an applicable herbicide and dye mixture,

All cut stumps will be treated with an applicable herbicide and dye mixture, to permanently extinguish the plants.

B.3 CLEARING OF VEGETATION STRIP

For the purpose of reduction of the fuel load, all felled vegetation will be removed from the area where it originated from, immediately after being cut.

No felled material will be left within the track formation, cut-off drains, culverts, service roads or any other place where it may cause an obstruction to TFR operations and or maintenance activities.

Spec.SAZ53257b

Part B

SAZ53257

CUTTING OF OVER GROWN VEGETATION CONTRACT

PREVIOUS RELATED EXPERIENCE WITH REFERENCES :

Note to tenderers:

Tenderers are required to demonstrate their experience in the provision of similar service and to this end shall supply a sufficient detailed reference list (minimum 5) with contact details of existing customers. Currently performed services by the Tenderer in the recent past in order to illustrate his potential to full fill the requirements of this tender.

LIST OF REFERENCES :			
Name of company	Contract Person	Description of service	Project size in value and or area

"PREVIEW COPY ONLY"

Signed : _____ Date: _____

Company name : _____

Part C

SAZ53257

CUTTING OF OVERGROWN VEGETATION CONTRACT

HEALTH & SAFETY PLAN:

Due consideration must be given to the deliverables required to execute and complete the contract as per the Quality Management Standard stated in the overview of service and should include compliance with the Occupational Health and Safety Act (OHSA) 85 of 1993 as amended and Construction Regulations but not be limited to:

- 1. The Contractor's Quality Policy.
- 2. Index of procedures to be used during the contract.
- 3. Training – record of staff training.
- 4. Staff Medicals

Attached submissions to this schedule :

.....

.....

.....

.....

.....

.....

.....

.....

.....

.....

.....

.....

.....

.....

.....

.....

"PREVIEW COPY ONLY"

Signed : _____ Date: _____

Company name : _____

Part D

SAZ53257

CUTTING OF OVER GROWN VEGETATION CONTRACT

RISK AND ENVIRONMENTAL PLAN:

Due consideration must be given to the deliverables required to execute and complete the contract as per the Quality Management Standard stated in the overview of service and should include compliance with the Occupational Health and Safety Act (OHSA) 85 of 1993 as amended and Construction Regulations but not be limited to:

1. The Risk Register.
2. Risk analysis methodology.
3. Environmental indicators.

Attached submissions to this schedule :

PREVIEW COPY ONLY

.....

.....

.....

.....

.....

.....

.....

.....

.....

.....

.....

.....

.....

.....

.....

.....

.....

.....

.....

.....

.....

.....

Signed : _____ Date: _____

Company name : _____

Part E

SAZ53257

CUTTING OF OVER GROWN VEGETATION CONTRACT

WORKING PROGRAM:

The tenderer is required to demonstrate to TFR that he/ she has the sufficient current and future capacity to carry out the work as detailed in the Project Specification/ Special conditions/ Price List, and that he has the capacity and plans in place to meet the required delivery schedule as required.

The following must be provided with the RFQ

1. Number of teams and team size.
2. Work rate of teams in Hectors.
3. List of Herbicides, including MSDS (material safety data sheet).
4. List of equipment to be utilised.
5. Method of vegetation control.
6. Indication if sub- contractor will be utilised

Index of documentation attached to this schedule :

.....

.....

.....

.....

.....

.....

.....

.....

.....

.....

.....

.....

.....

.....

.....

.....

.....

.....

.....

.....

.....

.....

Signed : _____ Date: _____

Company name : _____



Appendix (i)

GENERAL BID CONDITIONS - SERVICES

[January 2014]

"PREVIEW COPY ONLY"

TABLE OF CONTENTS

1	DEFINITIONS	3
2	GENERAL.....	3
3	SUBMISSION OF BID DOCUMENTS	3
4	USE OF BID FORMS.....	3
5	BID FEES.....	4
6	VALIDITY PERIOD	4
7	SITE VISIT / BRIEFING SESSION	4
8	CLARIFICATION BEFORE THE CLOSING DATE	4
9	COMMUNICATION AFTER THE CLOSING DATE	4
10	UNAUTHORISED COMMUNICATION ABOUT BIDS.....	4
11	RETURNABLE DOCUMENTS	5
12	DEFAULTS BY RESPONDENTS.....	5
13	CURRENCY.....	6
14	PRICES SUBJECT TO CONFIRMATION	6
15	ALTERATIONS MADE BY THE RESPONDENT TO BID PRICES	6
16	EXCHANGE AND REMITTANCE.....	6
17	ACCEPTANCE OF BID.....	7
18	NOTICE TO UNSUCCESSFUL RESPONDENTS.....	7
19	TERMS AND CONDITIONS OF CONTRACT.....	7
20	CONTRACT DOCUMENTS	7
21	LAW GOVERNING CONTRACT.....	8
22	IDENTIFICATION.....	8
23	CONTRACTUAL SECURITIES.....	8
24	DELETION OF ITEMS TO BE EXCLUDED FROM BID	8
25	VALUE-ADDED TAX.....	8
26	IMPORTANT NOTICE TO RESPONDENTS REGARDING PAYMENT	9
27	DELIVERY REQUIREMENTS	9
28	SPECIFICATIONS AND COPYRIGHT	10
29	BIDS BY OR ON BEHALF OF FOREIGN RESPONDENTS	10
30	CONFLICT WITH BID DOCUMENT	11

"PREVIEW COPY ONLY"

1 DEFINITIONS

Where the following words or phrases are used in this Agreement, such words or phrases shall have the meaning assigned thereto in this clause, except where the context clearly requires otherwise:

- 1.1 **Bid** shall mean a Respondent's tendered response / proposal to a Transnet RFP or RFQ;
- 1.2 **Bid Document(s)** shall mean a reference to a Request for Proposal or Request for Quotation;
- 1.3 **Day** shall mean any day other than a Saturday, Sunday or public holiday;
- 1.4 **Respondent(s)** shall mean a respondent/bidder to a Bid Document;
- 1.5 **RFP** shall mean Request for Proposal;
- 1.6 **RFQ** shall mean Request for Quotation;
- 1.7 **RFX** shall mean RFP or RFQ, as the case may be;
- 1.8 **Services** shall mean the services required by Transnet as specified in the Bid Document;
- 1.9 **Service Provider** shall mean the successful Respondent;
- 1.10 **Tax Invoice** shall mean the document as required by Section 20 of the Value-Added Tax Act, 89 of 1991, as may be amended from time to time;
- 1.11 **Transnet** shall mean Transnet SOC Ltd, a State Owned Company; and
- 1.12 **VAT** shall mean Value-Added Tax in terms of the Value-Added Tax Act, 89 of 1991, as may be amended from time to time.

2 GENERAL

All Bid Documents and subsequent contracts and orders shall be subject to the following general conditions as laid down by Transnet and are to be strictly adhered to by any Respondent to this RFX.

3 SUBMISSION OF BID DOCUMENTS

- 3.1 A Bid which shall hereinafter include reference to an RFP or RFQ, shall be submitted to Transnet no later than the closing date and time specified in accordance with the directions issued in the Bid Documents. Late Bids will not be considered.
- 3.2 Bids shall be delivered in a sealed envelope in accordance with the instructions indicated in the Bid Documents with the Bid number and subject marked on the front of the envelope.
- 3.3 The Respondent's return address must be stated on the reverse side of the sealed envelope.

4 USE OF BID FORMS

- 4.1 Where special forms are issued by Transnet for the submission of Bids, Respondents are required to submit their Bids by completion of the appropriate sections on such official forms and not in other forms or documents bearing their own terms and conditions of contract. Non-compliance with this condition may result in the rejection of a Bid.
- 4.2 Respondents must note that the original Bid forms must be completed for submission and not a reprocessed copy thereof.

- 4.3 Only if insufficient space has been allocated for a particular response may a Respondent submit additional information under separate cover using its company's letterhead. This must be duly cross-referenced in the RFX.

5 BID FEES

- 5.1 A non-refundable fee may be charged for Bid Documents, depending on the administrative cost of preparing and issuing such Bid Documents.
- 5.2 Only Respondents that have paid the Bid fee and provided proof of payment when submitting their Bid will be considered.

6 VALIDITY PERIOD

- 6.1 Respondents must hold their Bid valid for acceptance by Transnet at any time within the requested validity period after the closing date of the RFX.
- 6.2 Respondents may be requested to extend their validity period for a specified additional period. In such instances, Respondents will not be allowed to change any aspect of their Bid, unless they are able to demonstrate that the proposed change(s) is as a direct and unavoidable consequence of Transnet's extension of the validity period.

7 SITE VISIT / BRIEFING SESSION

Respondents may be requested to attend (i) a site visit where it is considered necessary to view the site prior to the preparation of Bids, or (ii) an RFX briefing session when Transnet deems it necessary to provide Respondents with additional information relevant to the compilation of their Bids. When such visits or sessions are indicated as compulsory in the Bid Document, Respondents are obliged to attend these meetings as failure to do so will result in their disqualification.

8 CLARIFICATION BEFORE THE CLOSING DATE

Should clarification be required on any aspect of the RFX before the closing date, the Respondent must direct such queries to the contact person identified in the Bid Document.

9 COMMUNICATION AFTER THE CLOSING DATE

After the closing date of a Bid [i.e. during the evaluation period] the Respondent may only communicate with the Secretary of the relevant Acquisition Council.

10 UNAUTHORISED COMMUNICATION ABOUT BIDS

Where Bids are submitted to the Secretary of an Acquisition Council, Respondents may at any time communicate with the Secretary on any matter relating to its Bid but, in the absence of written authority from the Secretary, no communication on a question affecting the subject of a Bid shall take place between Respondents or other potential service providers or any member of the Acquisition Council or official of Transnet during the period between the closing date for the receipt of the Bid and the date of the notification of the successful Respondent(s). A Bid, in respect of which any such unauthorised communication has occurred, could be disqualified.

11 RETURNABLE DOCUMENTS

All returnable documents listed in the RFX Documents must be submitted with Respondent's Bid. Failure to submit mandatory returnable schedules / documents will result in disqualification. Failure to submit other schedules / documents may result in disqualification.

12 DEFAULTS BY RESPONDENTS

12.1 If the Respondent, after it has been notified of the acceptance of its Bid fails to:

- a) enter into a formal contract when called upon to do so within such period as Transnet may specify; or
- b) accept an order in terms of the Bid;
- c) furnish satisfactory security when called upon to do so for the fulfilment of the contract; or
- d) comply with any condition imposed by Transnet,

Transnet may, in any such case, without prejudice to any other legal remedy which it may have, proceed to accept any other Bid or, if it is necessary to do so, call for Bids afresh, and may recover from the defaulting Respondent any additional expense incurred by Transnet in calling for new offers or in accepting a less favourable offer.

12.2 If any Respondent, who has submitted a Bid and/or concluded a contract with Transnet [hereinafter referred to as the **Service Provider**], or in the capacity of agent or subcontractor who has been associated with such Bid or contract:

- a) has withdrawn such Bid after the advertised date and hour for the receipt of Bids; or
- b) has, after having been notified of the acceptance of its Bid, failed or refused to sign a contract when called upon to do so in terms of any condition forming part of the Bid Documents; or
- c) has carried out any contract resulting from such Bid in an unsatisfactory manner or has breached any condition of such contract; or
- d) has offered, promised or given a bribe in relation to the obtaining or the execution of such contract; or
- e) has acted in a fraudulent or improper manner or in bad faith towards Transnet or any government department or towards any public body, company or person; or
- f) has made any misleading or incorrect statement either
 - (i) in the affidavit or certificate referred to in clause 18 [*Notice to Unsuccessful Respondents*]; or
 - (ii) in any other document submitted as part of its Bid submissionand is unable to prove to the satisfaction of Transnet that
 - it made the statement in good faith honestly believing it to be correct; and
 - before making such statement, it took all reasonable steps to satisfy itself of its correctness; or
- g) caused Transnet damage, or to incur costs in order to meet the Service Provider's requirements which could not be recovered from the Service Provider;
- h) has litigated against Transnet in bad faith;

- i) has been found guilty by a court of law, tribunal or other administrative body of a serious breach of any law, during the preceding 5 [five] years;
- j) has been included as a company or person prohibited from doing business with the public sector on National Treasury's database of Restricted Suppliers or Register of Bid Defaulters;

then a Bid from any such Respondent shall be disqualified and the person, enterprise or company [including any directors] shall, subject to clause 12.3 below, be disqualified from bidding for any Transnet business through its "blacklisting" process.

12.3 Any person or enterprise or company against whom a decision to blacklist has been taken, may make representations to the Chief Financial Officer of Transnet SOC Ltd, whose decision shall be final.

12.4 Any disqualification [**Blacklisting**] imposed upon any person or enterprise or company, may also apply to any other enterprise under the same or different names of disqualified persons or enterprise or company [or associates thereof] and may also be applied to any agent or employee of the person or enterprise or company concerned.

13 CURRENCY

All monetary amounts referred to in a Bid response must be in Rand, the currency of the Republic of South Africa [**ZAR**], save to the extent specifically permitted in the RFX.

14 PRICES SUBJECT TO CONFIRMATION

14.1 Prices which are quoted subject to confirmation will not be considered.

14.2 Firm prices quoted for the duration of any resulting order and/or contract will receive precedence over prices which are subject to fluctuation if this is in Transnet's best interests.

15 ALTERATIONS MADE BY THE RESPONDENT TO BID PRICES

All alterations made by the Respondent to its Bid price(s) prior to the submission of its Bid Documents must be done by deleting the incorrect figures and words where required and by inserting the correct figures and words against the items concerned. All such alterations must be initialled by the person who signs the Bid Documents. Failure to observe this requirement may result in the particular item(s) concerned being excluded in the matter of the award of the business.

16 EXCHANGE AND REMITTANCE

16.1 The Respondent should note that where the whole or a portion of the contract or order value is to be remitted overseas, Transnet shall, if requested to do so by the Service Provider, effect payment overseas directly to the foreign principal of such percentage of the contract or order value as may be stipulated by the Respondent in its Bid Documents.

16.2 It is Transnet's preference to enter into Rand-based agreements. Transnet would request, therefore, that the Respondent give favourable consideration to obtaining forward exchange cover on the foreign currency portion of the Agreement at a cost that is acceptable to Transnet to protect itself against any currency rate fluctuation risks for the duration of any resulting contract or order.

16.3 The Respondent who desires to avail itself of the aforementioned facility must at the time of bidding furnish the information called for in the *Exchange and Remittance* section of the Bid Documents and also furnish full details of the principals to whom payment is to be made.

- 16.4 The South African Reserve Bank's approval is required before any foreign currency payments can be made to or on behalf of Respondents.
- 16.5 Transnet will not recognise any claim for adjustment of the order and/or contract price if the increase in price arises after the date on which agreement on an overall Rand contract has been reached.
- 16.6 Transnet reserves the right to request a pro-forma invoice/tax invoice in order to ensure compliance with the contract and Value-Added Tax Act no. 89 of 1991 [**VAT Act**].

17 ACCEPTANCE OF BID

- 17.1 Transnet does not bind itself to accept the lowest priced or any Bid.
- 17.2 Transnet reserves the right to accept any Bid in whole or in part.
- 17.3 Upon the acceptance of a Bid by Transnet, the parties shall be bound by these General Bid Conditions and any contractual terms and/or any schedule of "Special Conditions" or otherwise which form part of the Bid Documents.
- 17.4 Where the Respondent has been informed by Transnet per fax message or email of the acceptance of its Bid, the acknowledgement of receipt transmitted shall be regarded as proof of delivery to the Respondent.

18 NOTICE TO UNSUCCESSFUL RESPONDENTS

Unsuccessful Respondents shall be advised in writing that their Bids have not been accepted as soon as possible after the closing date of the Bid. On award of business to the successful Respondent all unsuccessful Respondents shall be informed of the name of the successful Respondent and of the reason as to why their Bids have not been successful.

19 TERMS AND CONDITIONS OF CONTRACT

- 19.1 The Service Provider shall adhere to the Terms and Conditions of Contract issued with the Bid Documents, together with any schedule of "Special Conditions" or otherwise which form part of the Bid Documents.
- 19.2 Should the Respondent find any conditions unacceptable, it should indicate which conditions are unacceptable and offer amendments/ alternatives by written submission on its company letterhead. Any such submission shall be subject to review by Transnet's Legal Counsel who shall determine whether the proposed amendments/ alternative(s) are acceptable or otherwise, as the case may be.

20 CONTRACT DOCUMENTS

- 20.1 The contract documents will comprise these General Bid Conditions, the Terms and Conditions of Contract and any schedule of "Special Conditions" which form part of the Bid Documents.
- 20.2 The abovementioned documents together with the Respondent's Bid response will constitute the contract between the parties upon receipt by the Respondent of Transnet's letter of award / intent, subject to all additional amendments and/or special conditions thereto as agreed to by the parties.
- 20.3 Should Transnet inform the Respondent that a formal contract will be signed, the abovementioned documents together with the Respondent's Bid response [and, if any, its covering letter and any subsequent exchange of correspondence] as well as Transnet's Letter of Acceptance/Intent, shall constitute a binding contract until the final contract is signed.

21 LAW GOVERNING CONTRACT

The law of the Republic of South Africa shall govern the contract created by the acceptance of a Bid. The *domicilium citandi et executandi* shall be a place in the Republic of South Africa to be specified by the Respondent in its Bid at which all legal documents may be served on the Respondent who shall agree to submit to the jurisdiction of the courts of the Republic of South Africa. A foreign Respondent shall, therefore, state in its Bid the name of its authorised representative in the Republic of South Africa who is empowered to sign any contract which may be entered into in the event of its Bid being accepted and to act on its behalf in all matters relating to the contract.

22 IDENTIFICATION

If the Respondent is a company, the full names of the directors shall be stated in the Bid. If the Respondent is a close corporation, the full names of the members shall be stated in the Bid. If the Respondent is a partnership or an individual trading under a trade name, the full names of the partners or of such individual, as the case may be, shall be furnished.

23 CONTRACTUAL SECURITIES

23.1 The successful Respondent, when called upon to do so, shall provide security to the satisfaction of Transnet for the due fulfilment of a contract or order. Such security shall be in the form of an advanced payment guarantee [APG] and/or a performance bond [Performance Bond], as the case may be, to be furnished by an approved bank, building society, insurance or guarantee corporation carrying on business in South Africa.

23.2 The security may be applied in whole or part at the discretion of Transnet to make good any loss or damage which Transnet may incur in consequence of a breach of the contract or any part thereof.

23.3 Such security, if required, shall be an amount which will be stipulated in the Bid Documents.

23.4 The successful Respondent shall be required to submit to Transnet or Transnet's designated official the specified security document(s) within 30 [thirty] Days from the date of signature of the contract. Failure to return the securities within the prescribed time shall, save where prior extension has been granted, entitle Transnet without notice to the Service Provider to cancel the contract with immediate effect.

23.5 Additional costs incurred by Transnet necessitated by reason of default on the part of the Service Provider in relation to the conditions of this clause 23 will be for the account of the Service Provider.

24 DELETION OF ITEMS TO BE EXCLUDED FROM BID

The Respondent must delete items for which it does not wish to tender.

25 VALUE-ADDED TAX

25.1 In respect of local Services, i.e. Services to be rendered in the Republic of South Africa, the prices quoted by the Respondent are to be exclusive of VAT which must be shown separately at the standard rate on the Tax Invoice.

25.2 In respect of foreign Services rendered:

- a) the invoicing by a South African Service Provider on behalf of its foreign principal rendering such Service represents a Service rendered by the principal; and

- b) the Service Provider's Tax Invoice(s) for the local portion only [i.e. the "commission" for the Services rendered locally] must show the VAT separately.

26 IMPORTANT NOTICE TO RESPONDENTS REGARDING PAYMENT

26.1 Method of Payment

- a) The attention of the Respondent is directed to the Terms and Conditions of Contract which set out the conditions of payment on which Bid price(s) shall be based.
- b) However, in addition to the foregoing the Respondent is invited to submit offers based on alternative methods of payment and/or financing proposals.
- c) The Respondent is required to give full particulars of the terms that will be applicable to its alternative offer(s) and the financial merits thereof will be evaluated and taken into consideration when the Bid is adjudicated.
- d) The Respondent must, therefore, in the first instance, tender strictly in accordance with clause 26.1a) above. Failure to comply with clause 26.1a) above may preclude a Bid from further consideration.

NOTE: The successful Respondent [the **Service Provider**], where applicable, shall be required to furnish a guarantee covering any advance payments, as set out in clause 23 above [*Contractual Securities*].

26.2 Conditional Discount

Respondents offering prices which are subject to a conditional discount applicable for payment within a specific period are to note that the conditional period will be calculated from the date of receipt by Transnet of the Service Provider's month-end statement reflecting the relevant Tax Invoice(s) for payment purposes, provided the conditions of the order or contract have been fulfilled and the Tax Invoice is correct in all respects in terms of the contract or order. Incomplete and/or incorrect Tax Invoices shall be returned and the conditional discount period will be recalculated from the date of receipt of the correct documentation.

27 DELIVERY REQUIREMENTS

27.1 Period Contracts

It will be a condition of any resulting contract/order that the delivery period embodied therein will be governed by the provisions of the Terms and Conditions of Contract.

27.2 Progress Reports

The Service Provider may be required to submit periodical progress reports with regard to the delivery of the Services.

27.3 Emergency Demands as and when required

If, due to unforeseen circumstances, the rendering of the Services covered by the Bid are required at short notice for immediate delivery, the Service Provider will be given first right of refusal for such business. If it is unable to meet the desired critical delivery period, Transnet reserves the right to purchase such services as may be required to meet the emergency outside the contract if immediate delivery can be offered from any other source. The "*Total or Partial Failure to Perform the Scope of*

Services” section in the Terms and Conditions of Contract will not be applicable in these circumstances.

28 SPECIFICATIONS AND COPYRIGHT

28.1 Specifications

The Respondent should note that, unless notified to the contrary by Transnet or a designated official by means of an official amendment to the Bid Documents, it is required to tender for the Services strictly in accordance with the specifications supplied by Transnet.

28.2 Copyright

Copyright in plans, drawings, diagrams, specifications and documents compiled by the Service Provider for the purpose of contract work shall be governed by the *Intellectual Property Rights* section in the Terms and Conditions of Contract.

29 BIDS BY OR ON BEHALF OF FOREIGN RESPONDENTS

- 29.1 Bids submitted by foreign principals may be forwarded directly by the principals or by its South African representative or agent to the Secretary of the Acquisition Council or to a designated official of Transnet according to whichever officer is specified in the Bid Documents.
- 29.2 In the case of a representative or agent, written proof must be submitted to the effect that such representative or agent has been duly authorised to act in that capacity by the principal. Failure to submit such authorisation by the representative or agent shall disqualify the Bid.
- 29.3 When legally authorised to prepare and submit Bids on behalf of their principals not domiciled in the Republic of South Africa, representatives or agents must compile the Bids in the names of such principals and sign them on behalf of the latter.
- 29.4 South African representatives or agents of a successful foreign Respondent must when so required enter into a formal contract in the name of their principals and must sign such contract on behalf of the latter. In every such case a legal Power of Attorney from their principals must be furnished to Transnet by the South African representative or agents authorising them to enter into and sign such contract.
- a) Such Power of Attorney must comply with Rule 63 [Authentication of documents executed outside the Republic for use within the Republic] of the Uniform Rules of Court: Rules regulating the conduct of the proceedings of the several provincial and local divisions of the Supreme Court of South Africa.
 - b) The Power of Attorney must be signed by the principal under the same title as used in the Bid Documents.
 - c) If a Power of Attorney held by the South African representative or agent includes matters of a general nature besides provision for the entering into and signing of a contract with Transnet, a certified copy thereof should be furnished.
 - d) The Power of Attorney must authorise the South African representative or agent to choose the *domicilium citandi et executandi* as provided for in the Terms and Conditions of Contract.

29.5 If payment is to be made in South Africa, the foreign Service Provider [i.e. the principal, or its South African agent or representative], must notify Transnet in writing whether, for payment by electronic funds transfer [**EFT**]:

- a) funds are to be transferred to the credit of the foreign Service Provider's account at a bank in South Africa, in which case the name and branch of such bank shall be furnished; or
- b) funds are to be transferred to the credit of its South African agent or representative, in which case the name and branch of such bank shall be furnished.

30 CONFLICT WITH BID DOCUMENT

Should a conflict arise between these General Bid Conditions and the Bid Document issued, the conditions stated in the Bid Document shall prevail.

oooo0000oooo

"PREVIEW COPY ONLY"



Appendix (ii)

**STANDARD TERMS AND CONDITIONS OF CONTRACT
FOR THE PROVISION OF SERVICES TO TRANSNET
[January 2014]**

"PREVIEW COPY ONLY"

TABLE OF CONTENTS

1	INTRODUCTION.....	3
2	DEFINITIONS.....	3
3	INTERPRETATION.....	6
4	NATURE AND SCOPE.....	6
5	AUTHORITY OF PARTIES.....	7
6	WARRANTIES.....	7
7	TRANSNET'S OBLIGATIONS.....	9
8	GENERAL OBLIGATIONS OF THE SERVICE PROVIDER.....	9
9	B-BBEE AND SOCIO-ECONOMIC OBLIGATIONS.....	10
10	FEES AND EXPENSES.....	15
11	INVOICING AND PAYMENT.....	15
12	FEE ADJUSTMENTS.....	16
13	INTELLECTUAL PROPERTY RIGHTS.....	16
14	SERVICE PROVIDER'S PERSONNEL.....	18
15	LIMITATION OF LIABILITY.....	19
16	INSURANCES.....	19
17	CONFIDENTIALITY.....	20
18	TOTAL OR PARTIAL FAILURE TO PERFORM THE SCOPE OF SERVICES.....	21
19	TERM AND TERMINATION.....	22
20	CONSEQUENCE OF TERMINATION.....	22
21	ASSIGNMENT.....	23
22	FORCE MAJEURE.....	23
23	EQUALITY AND DIVERSITY.....	24
24	NON-WAIVER.....	24
25	PARTIAL INVALIDITY.....	24
26	DISPUTE RESOLUTION.....	24
27	ADDRESSES FOR NOTICES.....	25
28	WHOLE AND ONLY AGREEMENT.....	26
29	AMENDMENT AND CHANGE CONTROL.....	26
30	GOVERNING LAW.....	26
31	COUNTERPARTS.....	26

"PREVIEW COPY ONLY"

1 INTRODUCTION

When an Agreement is entered into between Transnet SOC Ltd [**Transnet**] and the appointed supplier of Services to Transnet [**the Service Provider**], these Standard Terms and Conditions of Contract, the technical specifications for the Services, a Work Order including such special conditions as may be applicable, and any terms in the associated Bid Documents, exclusively govern the provision of Services by the Service Provider to Transnet.

2 DEFINITIONS

Where the following words or phrases are used in the Agreement, such words or phrases shall have the meaning assigned thereto in this clause, except where the context clearly requires otherwise:

- 2.1 **AFSA** means the Arbitration Foundation of South Africa;
- 2.2 **Agreement** means the Agreement and its associated schedules and/or annexures and/or appendices, including the Work Order(s), specifications for the Services and such special conditions as shall apply to the Agreement, together with the General Tender Conditions and any additional provisions in the associated bid documents tendered by the Service Provider [as agreed in writing between the Parties], which collectively and exclusively govern the provision of Services by the Service Provider to Transnet;
- 2.3 **Background Intellectual Property** means all Intellectual Property introduced and required by either Party to give effect to their obligations under the Agreement owned in whole or in part by or licensed to either Party or their affiliates prior to the Commencement Date or developed after the Commencement Date otherwise pursuant to the Agreement;
- 2.4 **Business Day(s)** means Mondays to Fridays between 07:30 and 16:00, excluding public holidays as proclaimed in South Africa;
- 2.5 **Commencement Date** means [●], notwithstanding the signature date of the Agreement;
- 2.6 **Confidential Information** means any information or other data, whether in written, oral, graphic or in any other form such as in documents, papers, memoranda, correspondence, notebooks, reports, drawings, diagrams, discs, articles, samples, test results, prototypes, designs, plans, formulae, patents, or inventor's certificates, which a Party discloses or provides to the other Party [intentionally or unintentionally, or as a result of one Party permitting the representative of the other Party to visit any of its premises], or which otherwise becomes known to a Party, and which is not in the public domain and includes, without limiting the generality of the term:
- information relating to methods of operation, data and plans of the disclosing Party;
 - the contents of the Agreement;
 - private and personal details of employees or clients of the disclosing Party or any other person where an onus rests on the disclosing Party to maintain the confidentiality of such information;
 - any information disclosed by either Party and which is clearly marked as being confidential or secret;
 - information relating to the strategic objectives and planning of the disclosing Party relating to its existing and planned future business activities;

- f) information relating to the past, present and future research and development of the disclosing Party;
 - g) information relating to the business activities, business relationships, products, services, customers, clients and Subcontractors of the disclosing Party where an onus rests on the disclosing Party to maintain the confidentiality of such information;
 - h) information contained in the software and associated material and documentation belonging to the disclosing Party;
 - i) technical and scientific information, Know-How and trade secrets of a disclosing Party including inventions, applications and processes;
 - j) Copyright works;
 - k) commercial, financial and marketing information;
 - l) data concerning architecture, demonstrations, tools and techniques, processes, machinery and equipment of the disclosing Party;
 - m) plans, designs, concepts, drawings, functional and technical requirements and specifications of the disclosing Party;
 - n) information concerning faults or defects in goods, equipment, hardware or software or the incidence of such faults or defects; and
 - o) information concerning the charges, fees and / or costs of the disclosing Party or its authorised Subcontractors, or their methods, practices or service performance levels actually achieved;
- 2.7 **Copyright** means the right in expressions, procedures, methods of operations or mathematical concepts, computer program codes, compilations of data or other material, literary works, musical works, artistic works, sound recordings, broadcasts, program carrying signals, published editions, photographic works or cinematographic works of the copyright owner to do or to authorise the doing of certain acts specified in respect of the different categories of works;
- 2.8 **Default** means any breach of the obligations of either Party [including but not limited to a fundamental breach or breach of a fundamental term] or any Default, act, omission, negligence or statement of either Party, its employees, agents or Subcontractors in connection with or in relation to the subject of the Agreement and in respect of which such Party is liable to the other;
- 2.9 **Deliverable(s)** means any and all works of authorship, products and materials developed, written, prepared, assembled, integrated, modified or provided by the Service Provider in relation to the Services;
- 2.10 **Designs** mean registered Designs and/or Design applications and will include the monopoly right granted for the protection of an independently created industrial design including designs dictated essentially by technical or functional considerations as well as topographies of integrated circuits and integrated circuits;
- 2.11 **Fee(s)** shall mean the agreed Fees for the Services to be purchased from the Service Provider by Transnet, as detailed in the Work Order(s), issued in accordance with the Agreement, as amended by mutual agreement between the Parties and in accordance with the provisions of the Agreement from time to time;
- 2.12 **Foreground Intellectual Property** means all Intellectual Property developed by either Party pursuant to the Agreement;

- 2.13 **Intellectual Property** means Patents, Designs, Know-How, Copyright and Trade Marks and all rights having equivalent or similar effect which may exist anywhere in the world and includes all future additions and improvements to the Intellectual Property;
- 2.14 **Know-How** means all Confidential Information of whatever nature relating to the Intellectual Property and its exploitation as well as all other Confidential Information generally relating to Transnet's field of technology, including technical information, processing or manufacturing techniques, Designs, specifications, formulae, systems, processes, information concerning materials and marketing and business information in general;
- 2.15 **Materials** means the Deliverables, the Service Provider Materials and the Third Party Materials;
- 2.16 **Parties** mean the Parties to the Agreement together with their subsidiaries, divisions, business units, successors-in-title and their assigns;
- 2.17 **Party** means either one of these Parties;
- 2.18 Patents mean registered Patents and Patent applications, or the latter have proceeded to grant, and includes a right granted for any inventions, products or processes in all fields of technology;
- 2.19 **Permitted Purpose** means any activity or process to be undertaken or supervised by Personnel or employees of one Party during the term of the Agreement, for which purpose authorised disclosure of the other Party's Confidential Information or Intellectual Property is a prerequisite in order to enable such activity or process to be accomplished;
- 2.20 **Personnel** means any partner, employee, agent, consultant, independent associate or supplier, Subcontractor and the staff of such Subcontractor, or other authorised representative of either Party;
- 2.21 **Purchase Order(s)** means official orders issued by an operating division of Transnet to the Service Provider for the provision of Services;
- 2.22 **Service(s)** means [], the Service(s) provided to Transnet by the Service Provider, pursuant to the Work Order(s) in terms of the Agreement;
- 2.23 **Service Level Agreement** or **SLA** means the processes, deliverables, key performance indicators and performance standards relating to the Services to be provided by the Service Provider;
- 2.24 **Subcontract** means any contract or agreement or proposed contract or agreement between the Service Provider and any third party whereby that third party agrees to provide to the Service Provider the Services or any part thereof;
- 2.25 **Subcontractor** means the third party with whom the Service Provider enters into a Subcontract;
- 2.26 **Service Provider Materials** means all works of authorship, products and materials [including, but not limited to, data, diagrams, charts, reports, specifications, studies, inventions, software, software development tools, methodologies, ideas, methods, processes, concepts and techniques] owned by, or licensed to, the Service Provider prior to the Commencement Date or independently developed by the Service Provider outside the scope of the Agreement at no expense to Transnet, and used by the Service Provider in the performance of the Services;
- 2.27 **Tax Invoice** means the document as required by Section 20 of the Value-Added Tax Act, 89 of 1991, as may be amended from time to time;

- 2.28 **Third Party Material** means software, software development tools, methodologies, ideas, methods, processes, concepts and techniques owned by, or licensed to a third party and used by the Service Provider in the performance of the Services;
- 2.29 **Trade Marks** mean registered Trade Marks and trade mark applications and includes any sign or logo, or combination of signs and/or logos capable of distinguishing the goods or services of one undertaking from those of another undertaking;
- 2.30 **VAT** means Value-Added Tax chargeable in terms of the Value-Added Tax Act, 89 of 1991, as may be amended from time to time; and
- 2.31 **Work Order(s)** means a detailed scope of work for a Service required by Transnet, including timeframes, Deliverable, Fees and costs for the supply of the Service to Transnet, which may be appended to the Agreement from time to time.

3 INTERPRETATION

- 3.1 Clause headings in the Agreement are included for ease of reference only and do not form part of the Agreement for the purposes of interpretation or for any other purpose. No provision shall be construed against or interpreted to the disadvantage of either Party hereto by reason of such Party having or being deemed to have structured or drafted such provision.
- 3.2 Any term, word, acronym or phrase used in the Agreement, other than those defined under the clause heading "Definitions" shall be given its plain English meaning, and those terms, words, acronyms, and phrases used in the Agreement will be interpreted in accordance with the generally accepted meanings accorded thereto.
- 3.3 A reference to the singular incorporates a reference to the plural and *vice versa*.
- 3.4 A reference to natural persons incorporates a reference to legal persons and *vice versa*.
- 3.5 A reference to a particular gender incorporates a reference to the other gender.

4 NATURE AND SCOPE

- 4.1 The Agreement is an agreement under the terms and conditions of which the Service Provider will arrange for the provision to Transnet of the Services which meet the requirements of Transnet, the delivery of which Services is controlled by means of Purchase Orders to be issued by Transnet and executed by the Service Provider, in accordance with the Agreement.
- 4.2 Such Purchase Orders shall be agreed between the Parties from time to time, subject to the terms of the relevant Work Order(s).
- 4.3 Each properly executed Purchase Order forms an inseparable part of the Agreement as if it were fully incorporated into the body of the Agreement.
- 4.4 During the period of the Agreement, both Parties can make written suggestions for amendments to the Work Order(s), in accordance with procedures set out in clause 29 [Amendment and Change Control] below. A Party will advise the other Party within 14 [fourteen] Business Days, or such other period as mutually agreed, whether the amendment is acceptable.
- 4.5 Insofar as any term, provision or condition in the Work Order(s) conflicts with a like term, provision or condition in the Agreement and/or a Purchase Order, or where the Agreement is silent on the matter, the term, provision or condition in this Master Agreement shall prevail, unless such term or provision or condition in this Master Agreement has been specifically revoked or amended by mutual written agreement between the Parties.

- 4.6 Time will be of the essence and the Service Provider will perform its obligations under the Agreement in accordance with the timeframe(s) [if any] set out in the relevant schedule, save that the Service Provider will not be liable under this clause if it is unable to meet such obligation within the time required as a direct result of any act or omission by Transnet and it has used its best endeavours to advise Transnet of such act or omission. In the event of such delay, any time deadlines detailed in the relevant schedule shall be extended by a period equal to the period of that delay.

5 AUTHORITY OF PARTIES

- 5.1 Nothing in the Agreement will constitute or be deemed to constitute a partnership between the Parties, or constitute or be deemed to constitute the Parties as agents or employees of one another for any purpose or in any form whatsoever.
- 5.2 Neither Party shall be entitled to, or have the power or authority to enter into an agreement in the name of the other; or give any warranty, representation or undertaking on the other's behalf; or create any liability against the other or bind the other's credit in any way or for any purpose whatsoever.

6 WARRANTIES

- 6.1 The Service Provider warrants to Transnet that:
- it has full capacity and authority to enter into and to perform the Agreement and that the Agreement is executed by a duly authorised representatives of the Service Provider;
 - it will discharge its obligations under the Agreement and any annexure, appendix or schedule hereto with all due skill, care and diligence;
 - it will be solely responsible for the payment of remuneration and associated benefits, if any, of its Personnel and for withholding and remitting income tax for its Personnel in conformance with any applicable laws and regulations;
 - it will procure licences for Transnet in respect of all Third Party Material detailed in the Work Order(s), and will procure the right for Transnet to take such copies [in whole or in part] of such Third Party Materials as it may reasonably require for the purposes of back-up for archiving and disaster recovery; and
 - the use or possession by Transnet of any Materials will not subject Transnet to any claim for infringement of any Intellectual Property Rights of any third party.
- 6.2 The Service Provider warrants that it will perform its obligations under the Agreement in accordance with the Service Levels as defined in the relevant schedule. Transnet may at its discretion audit compliance with the Service Levels, provided that any such audit is carried out with reasonable prior notice and in a reasonable way so as not to have an adverse effect on the performance of the Services. Without prejudice to clause 6.3 below, in the event that the Service Provider fails to meet the Service Levels, Transnet may claim appropriate service credits or invoke a retention of Fees as detailed in the relevant schedule and/or Work Order.
- 6.3 The Service Provider warrants that for a period of 90 [ninety] days from Acceptance of the Deliverables they will, if properly used, conform in all material respects with the requirements set out in the relevant schedule. The Service Provider will at its expense remedy any such non-conformance as soon as possible but in any event within 30 [thirty] days of notification by

Transnet. In the event that the Service Provider fails or is unable to remedy such non-conformance within such time-scale, Transnet will be entitled to employ a third party to do so in place of the Service Provider and any excess charges or costs incurred by Transnet as a result shall be paid by the Service Provider.

6.4 The Service Provider will remedy any defect within 30 [thirty] days of being notified of that defect by Transnet in writing.

6.5 The Service Provider will not be liable to remedy any problem arising from or caused by any modification made by Transnet to the Deliverables, or any part thereof, without the prior approval of the Service Provider.

6.6 The Service Provider shall advise Transnet of the effects of any steps proposed by Transnet pursuant to clause 6.5 above, including but not limited to any cost implications or any disruption or delay in the performance of the Services. The Parties agree that any changes to the Services, including the charges for the Services or any timetables for delivery of the Services, will be agreed in accordance with the change control procedure, as set out in clause 29 [Amendment and Change Control].

6.7 The Service Provider warrants that:

- a) it has, using the most up-to-date software available, tested for [and deleted] all commonly known viruses in the Materials and for all viruses known by the Service Provider at the date of the relevant Work Order; and
- b) at the time of delivery to Transnet, the Materials do not contain any trojan horse, worm, logic bomb, time bomb, back door, trap door, keys or other harmful components.

The Service Provider agrees that, in the event that a virus is found, it will at its own expense use its best endeavours to assist Transnet in reducing the effect of the virus and, particularly in the event that a virus causes loss of operational efficiency or loss of data, to assist Transnet to the same extent to mitigate such losses and to restore Transnet to its original operating efficiency.

6.8 The Service Provider undertakes to comply with South Africa's general privacy protection in terms of Section 14 of the Bill of Rights in connection with the Agreement and shall procure that its Personnel shall observe the provisions of Section 14 [as applicable] or any amendments and enactments thereof and any regulations made pursuant thereto.

6.9 The Service Provider warrants that it has taken all reasonable precautions to ensure that, in the event of a disaster, the impact of such disaster on the ability of the Service Provider to comply with its obligations under the Agreement will be reduced to the greatest extent possible, and that the Service Provider shall ensure that it has appropriate, tested and documented recovery arrangements in place.

6.10 In compliance with the National Railway Safety Regulator Act, 16 of 2002, the Service Provider shall ensure that the Services, to be supplied to Transnet under the terms and conditions of the Agreement, comply fully with the specifications as set forth in Schedule 1 hereto, and shall thereby adhere [as applicable] to railway safety requirements and/or regulations. Permission for the engagement of a Subcontractor by the Service Provider [as applicable] shall be subject to a review of the capability of the proposed Subcontractor to comply with the specified railway safety requirements and/or regulations. The Service Provider and/or its Subcontractor shall grant Transnet access, during the term of the Agreement, to review any safety-related activities, including the coordination of such activities across all parts of its organisation.

7 TRANSNET'S OBLIGATIONS

- 7.1 Transnet undertakes to promptly comply with any reasonable request by the Service Provider for information, including information concerning Transnet's operations and activities, that relates to the Services as may be necessary for the Service Provider to perform the Services, but for no other purpose. However, Transnet's compliance with any request for information is subject to any internal security rules and requirements and subject to the observance by the Service Provider of its confidentiality obligations under the Agreement.
- 7.2 The Service Provider shall give Transnet reasonable notice of any information it requires in accordance with clause 7.1 above.
- 7.3 Subject to clause 14 [*Service Provider's Personnel*], Transnet agrees to provide the Service Provider or its Personnel such access to and use of its facilities as is necessary to allow the Service Provider to perform its obligations under the Agreement.

8 GENERAL OBLIGATIONS OF THE SERVICE PROVIDER

- 8.1 The Service Provider shall:
- a) respond promptly to all complaints and enquiries from Transnet;
 - b) inform Transnet immediately of any dispute or complaint arising in relation to the provision of the Services;
 - c) conduct its business in a professional manner that will reflect positively upon the Service Provider and the Service Provider's Services;
 - d) keep full records clearly indicating all transactions concluded by the Service Provider relating to the performance of the Services and keep such records for at least 5 [five] years from the date of each such transaction;
 - e) obtain, and at all times maintain in full force and effect, any and all licences, permits and the like required under applicable laws for the provision of the Services and the conduct of the business and activities of the Service Provider;
 - f) observe and ensure compliance with all requirements and obligations as set out in the labour and related legislation of South Africa, including the Occupational Health and Safety Act, 85 of 1993;
 - g) comply with all applicable environmental legislation and regulations, and demonstrate sound environmental policies, management and performance; and
 - h) ensure the validity of all renewable certifications, including but not limited to its Tax Clearance Certificate and B-BBEE Verification Certificate, for the duration of the Agreement. Should the Service Provider fail to present Transnet with such renewals as they become due, Transnet shall be entitled, in addition to any other rights and remedies that it may have in terms of the Agreement, to terminate the Agreement forthwith without any liability and without prejudice to any claims which Transnet may have for damages against the Service Provider.
- 8.2 The Service Provider acknowledges and agrees that it shall at all times:
- a) render the Services and perform all its duties with honesty and integrity;
 - b) communicate openly and honestly with Transnet and demonstrate a commitment to performing the Services timeously, efficiently and to the required standards;

- c) endeavour to provide the highest possible standards of service and professionalism, with a reasonable degree of care and diligence;
- d) use its best endeavours and make every diligent effort to meet agreed deadlines;
- e) treat its own Personnel, as well as all Transnet's officers, employees, agents and consultants, with fairness and courtesy and respect for their human rights;
- f) practice and promote its own internal policies aimed at prohibiting and preventing unfair discrimination [as further referred to in clause 23 – *Equality and Diversity*];
- g) treat all enquiries from Transnet in connection with the Services with courtesy and respond to all enquiries promptly and efficiently. Where the Service Provider is unable to comply with the provisions of this clause, the Service Provider will advise Transnet of the delay and the reasons therefor and will keep Transnet informed of progress made regarding the enquiry;
- h) when requested by Transnet, provide clear and accurate information regarding the Service Provider's own policies and procedures, excluding Know-How and other Confidential Information, except where a non-disclosure undertaking has been entered into between the Parties;
- i) not allow a conflict of interest to develop between its own interests [or the interests of any of its other customers] and the interests of Transnet;
- j) not accept or offer, nor allow, induce or promote the acceptance or offering of any gratuity, enticement, incentive or gift that could reasonably be regarded as bribery or an attempt to otherwise exert undue influence over the recipient;
- k) not mislead Transnet or its officers, employees and stakeholders, whether by act or omission;
- l) not otherwise act in an unethical manner or do anything which could reasonably be expected to damage or tarnish Transnet's reputation or business image; and
- m) immediately report to Transnet any unethical, fraudulent or otherwise unlawful conduct of which it becomes aware in connection with Transnet or the provision of Services.

9 B-BBEE AND SOCIO-ECONOMIC OBLIGATIONS

9.1 B-BBEE Scorecard

- a) Transnet fully endorses and supports the Broad-Based Black Economic Empowerment Programme and is strongly of the opinion that all South African business enterprises have an equal obligation to redress the imbalances of the past. It is also a fundamental requirement of the RFP that the Service Provider/Supplier also contributes to the Supplier Development Programme, as applied by Transnet.
- b) In response to this requirement, the Service Provider shall submit to Transnet's Contract Manager or such other designated person details of its B-BBEE status in terms of the latest Codes of Good Practice issued in terms of the B-BBEE Act and proof thereof at the beginning of March each year during the currency of the Agreement.
- c) The Service Provider undertakes to notify and provide full details to Transnet in the event there is:

- (i) a change in the Service Provider's B-BBEE status which is less than what it was at the time of its appointment including the impact thereof; and
 - (ii) a corporate or internal restructure or change in control of the Service Provider which has or likely to impact negatively on the Service Provider's B-BBEE status.
- d) Notwithstanding any other reporting requirement in terms hereof, the Service Provider undertakes to provide any B-BBEE data (underlying data relating to the Service Provider which has been relied upon or utilised by a verification agency or auditor for the purposes of issuing a verification certificate in respect of the Service Provider B-BBEE status) which Transnet may request on written notice within 30 (thirty) days of such request. A failure to provide such data shall constitute a Service Provider Default and may be dealt with in accordance with the provisions of clause 19 **Error! Reference source not found.**
- e) In the event there is a change in the Service Provider's B-BBEE status, then the provisions of clause 19 **Error! Reference source not found.** shall apply.

9.2 B-BBEE Improvement Plan

- a) Transnet encourages its Service Providers to constantly strive to improve their B-BBEE levels. To this end, the Service Provider undertakes to provide Transnet with a B-BBEE Improvement Plan to indicate the extent to which their B-BBEE status will be maintained or improved over the contract period, as per Annexure of the RFP.
- b) The Service Provider shall, for the duration of the Agreement, comply with the B-BBEE Improvement Plan.
- c) The terms of the B-BBEE Improvement Plan and monetary value of the commitments thereunder shall not (unless otherwise agreed in writing) be less or less favourable than the commitments made by the Service Provider in such B-BBEE Improvement Plan.

9.3 Supplier Development Implementation Plan

- a) In addition to the Supplier Development Plan which the Service Provider provided as part of its bid, the Service Provider undertakes, as stipulated in the RFP, to provide Transnet with a Supplier Development Implementation Plan [**the Implementation Plan**] setting out the nature, extent and monetary value of the Service Provider's commitments which the Service Provider shall undertake, as well as mechanisms and procedures to allow for access to information and verification of the Service Provider's compliance with the Implementation Plan, as shall be agreed with Transnet but in any event no later than 45 (forty five) days from the signature date of the LOI/LOA.
- b) The Parties undertake to negotiate in good faith with a view to agreeing the content of the Implementation Plan by no later than 45 (forty five) days as aforesaid (or such later date as Transnet may consent to in writing).
- c) If the Parties (acting reasonably and in good faith with due consideration to the Supplier Development Plan proposed by the Service Provider in response to the RFP fail to reach agreement on the Supplier Development Implementation Plan within the time limit stipulated in the clause above, it shall constitute a Service Provider Default and Clause 19 **Error! Reference source not found.** shall apply.
- d) The Supplier's Implementation Plan shall include, but not be limited to Technology transfer, New skills development, Job creation, Job preservation, Small business promotion and Rural integration and regional development.

- e) The terms of the Implementation Plan's and the monetary value of the commitments thereunder shall not (unless otherwise agreed in writing) be less or less favourable than the commitments made by the Service Provider in the Supplier Development Implementation Plan.

9.4 **Green Economy/Carbon Footprint**

- a) In addition to the Supplier Development and B-BBEE commitments that the Service Provider makes, the Service Provider has in its bid provided Transnet with an understanding of the Service Provider's position with regard to issues such as waste disposal, recycling and energy conservation.

9.5 **Reporting**

- a) The Service Provider shall monitor, audit, and record in an auditable manner, its own implementation and compliance with the B-BBEE Improvement Plan and the Supplier Development Implementation Plan and provide the Contract Manager with such information as the Contract Manager may reasonably request concerning the implementation of the B-BBEE Improvement Plan and the Supplier Development Implementation Plan.
- b) The Service Provider shall, every 3 (three) months from the Commencement Date and within 7 (seven) days of the end of the calendar month of that 3 (three) months period, provide Transnet with a report (for monitoring purposes only) in respect of each of the undertakings stipulated in this clause 9.5.
- c) Transnet, through its Supplier Development division, shall, every 6 (six) months from the Commencement Date, review and verify the Service Provider's undertakings stipulated in this clause with respect to B-BBEE and Supplier Development commitments, based on the Service Provider's report.
- d) The Service Provider shall attach adequate proof to enable Transnet to verify compliance with the B-BBEE Improvement Plan and Supplier Development Implementation Plan.
- e) Post verification of the submitted report to Transnet, Transnet shall engage with the Service Provider on the findings. The Contract Manager, assisted by the relevant specialist from Transnet's Supplier Development division, must report to the Service Provider at the end of every 6 (six) months as to whether or not the Contract Manager and/or the Supplier Development specialist reasonably considers, based on the information available to it, that the Service Provider has during such time complied with the B-BBEE Improvement Plan and the Supplier Development Implementation Plan and the extent, if any, to which the Service Provider has not so complied.
- f) Without prejudice to the Transnet's rights under the Agreement:
 - (i) if the Contract Manager and/or Transnet's Supplier Development specialist reasonably considers that the Service Provider is not at any time complying with B-BBEE Improvement Plan and/or the Supplier Development Implementation Plan, the Contract Manager and/or the Supplier Development specialist may make such recommendations as is considered reasonably appropriate to the Service Provider as to the steps he reasonably considers should be taken by the Service Provider in order for the Service Provider to remedy such non-compliance and the time period within which such steps must be taken;

- (ii) If such recommendations are not implemented by the Service Provider in accordance with such recommendations, then the provisions of clause 9.6; and
 - (iii) Transnet may at any time request a meeting with the Service Provider to consider any non-compliance reported to it by the Supplier Development specialist of Transnet and/or the Contract Manager or which otherwise comes to its attention. Both Parties must attend such a meeting and negotiate in good faith with a view to reach agreement on the steps or actions that the Service Provider must undertake in order to remedy that non-compliance.
- g) In the event the Service Provider is found not to have met the B-BBEE and Supplier Development requirements agreed upon in the B-BBEE Improvement Plan and the Supplier Development Implementation Plan, and/or is found to be fraudulent in submitting the reports, then Transnet shall impose a non-compliance penalty as provided for in clause 9.6 below or shall be entitled to terminate in terms of clauses 18 and 19.
- h) For the sake of completion of its contractual obligations, the Service Provider shall be obliged to complete all the undertakings made under the B-BBEE Improvement Plan and the Supplier Development Implementation Plan 5 to 6 months before the Termination Date.

9.6 Penalties

Non Compliance Penalties:

- a) If the Service Provider fails, at any time, to achieve its commitments under and in accordance with the B-BBEE Improvement Plan and the Supplier Development Implementation Plan ("a **Non Compliance**"), the Service Provider shall, subject to Clause 9.6 [*Non Compliance Penalty Cap*], pay a Non Compliance penalty ("Non Compliance Penalty") to Transnet in respect of such Non Compliance at the applicable rate ("Applicable Rate"), as prescribed in clause 9.6(i) below.

(i) Non Compliance Penalties shall be calculated as a percentage of the Contract Value and accrue at the Applicable Rate per month until:

(ii) the date on which the Service Provider has remedied such Non Compliance by complying with the Supplier Development Implementation Plan and/or the B-BBEE Improvement Plan (as applicable); or if earlier

(iii) the Agreement being terminated.

Applicable Rates of Non Compliance Penalties (for Large Enterprises Only):

- b) In relation to the Supplier Development Implementation Plan, Non Compliance Penalties shall accrue at the following Applicable Rates:

(i) for the first month (or part thereof), a rate of 0.25% (one quarter per cent);

(ii) for the second month (or part thereof), a rate of 0.5% (one half a per cent);

(iii) for the third month (or part thereof), a rate of 1.0% (one per cent);

(iv) for the fourth month (or part thereof), a rate of 1.25% (one and one quarter per cent); and

(v) for any period of Non Compliance after the fourth month, a rate of 1.5% (one and a half per cent).

- c) In relation to the B-BBEE Improvement Plan, Non Compliance Penalties shall accrue at the following Applicable Rates:
- (i) for the first month (or part thereof), a rate of 1.0% (one per cent);
 - (ii) for the second month (or part thereof), a rate of 1.5% (one and a half per cent);
 - (iii) for the third month (or part thereof), a rate of 2.0% (two per cent);
 - (iv) for the fourth month (or part thereof), a rate of 2.5% (two and a half per cent); and
 - (v) for any period of Non Compliance after the fourth month, a rate of 3% (three per cent).

Non Compliance Penalty Cap (for Large Enterprises):

- d) The maximum amount of the Service Provider's liability to pay Non Compliance Penalties under this clause 9.6 shall not exceed:
- (i) in the case of the Supplier Development Implementation Plan, 5% (five per cent) of the Contract Value; and
 - (ii) in the case of the B-BBEE Improvement Plan, 5% (five per cent) of the Contract Value, (each a Non Compliance Cap).

Applicable Rates of Non Compliance Penalties (for QSEs and EMEs):

- e) In relation to the Supplier Development Implementation Plan, Non Compliance Penalties shall apply annually at the rate of 0.5% (one half per cent);
- f) In relation to the B-BBEE Improvement Plan, Non Compliance Penalties shall apply annually at the rate of 0.5% (one half per cent).

Non Compliance Penalty Cap (for QSEs and EMEs):

- g) The maximum amount of the Service Provider's liability to pay Non Compliance Penalties under this Clause 9.6 shall not exceed:
- h) in the case of the Supplier Development Implementation Plan, 1.5% (one and a half per cent) of the Contract Value; and
 - i) in the case of the B-BBEE Improvement Plan, 1.5% (one and a half per cent) of the Contract Value, (each a Non Compliance Cap).

Non Compliance Penalty Certificate:

- j) If any Non Compliance Penalty arises, the Contract Manager shall issue a Non Compliance Penalty Certificate on the last day of each month during such Non Compliance indicating the Non Compliance Penalties which have accrued during that period.
- k) A Non Compliance Penalty Certificate shall be prima facie proof of the matters to which it relates. If the Service Provider disputes any of the amounts set out in a Non Compliance Penalty Certificate:
 - (i) the dispute shall be resolved in accordance with the provisions of the Agreement; and
 - (ii) if pursuant to that referral, it is determined that the Service Provider owes any amount to Transnet pursuant to the Non Compliance Penalty Certificate, then the Service Provider shall pay such amount to Transnet within 10 (ten) Business Days of

the determination made pursuant to such determination and an accompanying valid Tax Invoice.

Payment of Non Compliance Penalties:

- l) Subject to Clause k), the Service Provider shall pay the Non Compliance Penalty indicated in the Non Compliance Penalty Certificate within 10 (ten) Business Days of Transnet issuing a valid Tax Invoice to the Service Provider for the amount set out in that certificate. If Transnet does not issue a valid Tax Invoice to the Service Provider for Non Compliance Penalties accrued during any relevant period, those Non Compliance Penalties shall be carried forward to the next period.
- m) The Service Provider shall pay the amount due within 10 (ten) days after receipt of a valid Tax Invoice from Transnet, failing which Transnet shall, without prejudice to any other rights of Transnet under the Agreement, be entitled to call for payment which may be in any form Transnet deems reasonable and/or appropriate.
- n) Should the Service Provider fail to pay any Non Compliance Penalties within the time indicated in above (as applicable), Transnet shall be entitled to deduct the amount not paid by the Service Provider from the account of the Service Provider in the ensuing month.
- o) The Non Compliance Penalties set forth in this Clause 9.6 are stated exclusive of VAT. Any VAT payable on Non Compliance Penalties will be for the account of the Service Provider.

10 FEES AND EXPENSES

- 10.1 In consideration of the provision of the Services, Transnet will pay to the Service Provider the Fees detailed in the relevant schedule or Work Order.
- 10.2 Transnet will not be invoiced for materials used in the provision of the Services save for those materials [if any] set out in the Work Order and accepted by Transnet or in any relevant Work Order [which will be invoiced to Transnet at cost].
- 10.3 Unless otherwise agreed in a schedule or Work Order, Transnet will reimburse to the Service Provider all reasonable and proper expenses incurred directly and solely in connection with the provision of the Services, provided that all such expenses:
 - a) are agreed by Transnet in advance;
 - b) are incurred in accordance with Transnet's standard travel and expenses policies;
 - c) are passed on to Transnet at cost with no administration fee; and
 - d) will only be reimbursed if supported by relevant receipts.
- 10.4 All Tax Invoices relating to Fees, out of pocket expenses and, if applicable, travel and accommodation costs, will provide the detail for each of the Personnel carrying out the Services and incurring the expenses, and the Tax Invoice will, where appropriate, include VAT as a separate item.

11 INVOICING AND PAYMENT

- 11.1 Transnet shall pay the Service Provider the amounts stipulated in the relevant schedule or Work Order, subject to the terms and conditions of the Agreement.
- 11.2 Transnet shall pay such amounts to the Service Provider, upon receipt of a valid and undisputed Tax Invoice together with the supporting documentation as specified in the Work Order appended

hereto, once the valid and undisputed Tax Invoices, or such portion of the Tax Invoices which are valid and undisputed become due and payable to the Service Provider for the provision of the Services, in terms of clause 11.4 below.

- 11.3 All Fees and other sums payable under the Agreement are exclusive of VAT, which will be payable at the applicable rate.
- 11.4 Unless otherwise provided for in the Work Order(s) appended to the Agreement, Tax Invoices shall be submitted together with a month-end statement. Payment against such month-end statement shall be made by Transnet within 30 [thirty] days after date of receipt by Transnet of the statement together with all valid and undisputed Tax Invoices and supporting documentation.
- 11.5 Where the payment of any Tax Invoice, or any part thereof which is not in dispute, is not made in accordance with this clause 11, the Service Provider shall be entitled to charge interest on the outstanding amount, at The Standard Bank of South Africa's prime rate of interest in force, for the period from the due date of payment until the outstanding amount is paid.

12 FEE ADJUSTMENTS

- 12.1 Fees for Services rendered in terms of the Agreement shall be subject to review as indicated in the Work Order(s) annexed hereto from time to time.
- 12.2 No less than 2 [two] months prior to any proposed Fee adjustment, the Parties shall commence negotiations for Fees for the next period or as otherwise indicated and appended hereto.
- 12.3 Should Transnet and the Service Provider fail to reach an agreement on Fees for the successive period, either Party shall be entitled to submit this matter to dispute resolution in accordance with clause 26 of this Master Agreement [*Dispute Resolution*].

13 INTELLECTUAL PROPERTY RIGHTS

13.1 Title to Confidential Information

- a) Transnet will retain all right, title and interest in and to its Confidential Information and Background Intellectual Property and the Service Provider acknowledges that it has no claim of any nature in and to the Confidential Information and Background Intellectual Property that is proprietary to Transnet. For the avoidance of doubt, all the Service Provider's Background Intellectual Property shall remain vested in the Service Provider.
- b) Transnet shall grant to the Service Provider an irrevocable, royalty free, non-exclusive licence to use Transnet's Background Intellectual Property only for the Permitted Purpose. This licence shall not permit the Service Provider to sub-license to other parties.
- c) The Service Provider shall grant to Transnet an irrevocable, royalty free, non-exclusive licence to use the Service Provider's Background Intellectual Property for the Permitted Purpose. This licence shall not permit Transnet to sub-license to other parties.
- d) The Service Provider shall grant Transnet access to the Service Provider's Background Intellectual Property on terms which shall be *bona fide* negotiated between the Parties for the purpose of commercially exploiting the Foreground Intellectual Property, to the extent that such access is required.

13.2 Title to Intellectual Property

- a) All right, title and interest in and to Foreground Intellectual Property prepared, conceived or developed by the Service Provider, its researchers, agents and employees shall vest in

Transnet and the Service Provider acknowledges that it has no claim of any nature in and to the Foreground Intellectual Property. The Service Provider shall not at any time during or after the termination or cancellation of the Agreement dispute the validity or enforceability of such Foreground Intellectual Property, or cause to be done any act or anything contesting or in any way impairing or tending to impair any part of that right, title and interest to any of the Foreground Intellectual Property and shall not counsel or assist any person to do so.

- b) Transnet shall be entitled to seek protection in respect of the Foreground Intellectual Property anywhere in the world as it shall decide in its own absolute discretion and the Service Provider shall reasonably assist Transnet in attaining and maintaining protection of the Foreground Intellectual Property.
- c) Where the Foreground Intellectual Property was created by the Service Provider or its researchers, agents and employees and where Transnet decides not to exercise its option to seek protection or decides to discontinue the financial support of the prosecution or maintenance of any such protection, Transnet shall notify the Service Provider who shall have the right of first refusal to file or continue prosecution or maintain any such applications and to maintain any protection issuing on the Foreground Intellectual Property.
- d) No consideration shall be paid by Transnet to the Service Provider for the assignment of any Foreground Intellectual Property from the Service Provider to Transnet, over and above the sums payable in terms of the Agreement. The Service Provider undertakes to sign all documents and do all things as may be necessary to effect, record and perfect the assignment of the Foreground Intellectual Property to Transnet.
- e) Subject to anything contrary contained in the Agreement and/or the prior written consent of Transnet (which consent shall not be unreasonably withheld or delayed), the Service Provider shall under no circumstances be entitled as of right, or to claim the right, to use Transnet's Background Intellectual Property and/or Foreground Intellectual Property.

13.3 **Title to Improvements**

Any improvements, developments, adaptations and/or modifications to the Foreground Intellectual Property, and any and all new inventions or discoveries, based on or resulting from the use of Transnet's Background Intellectual Property and/or Confidential Information shall be exclusively owned by Transnet. The Service Provider shall disclose promptly to Transnet all such improvements, developments, adaptations and/or modifications, inventions or discoveries. The Service Provider hereby undertakes to sign all documents and do all things as may be necessary to effect, record and perfect the assignment of such improvements, developments, adaptations and/or modifications, inventions or discoveries to Transnet and the Service Provider shall reasonably assist Transnet in attaining, maintaining or documenting ownership and/or protection of the improved Foreground Intellectual Property.

13.4 **Unauthorised Use of Confidential Information**

The Service Provider shall not authorise any party to act on or use in any way any Confidential Information belonging to Transnet whether or not such party is aware of such Confidential Information, and shall promptly notify Transnet of the information if it becomes aware of any party so acting, and shall provide Transnet the information with such assistance as Transnet reasonably requires, at Transnet's cost and expense, to prevent such third party from so acting.

13.5 Unauthorised Use of Intellectual Property

- a) The Service Provider agrees to notify Transnet in writing of any conflicting uses of, and applications of registrations of Patents, Designs and Trade Marks or any act of infringement, unfair competition or passing off involving the Intellectual Property of Transnet of which the Service Provider acquires knowledge and Transnet shall have the right, as its own option, to proceed against any party infringing its Intellectual Property.
- b) It shall be within the sole and absolute discretion of Transnet to determine what steps shall be taken against the infringer and the Service Provider shall co-operate fully with Transnet, at Transnet's cost, in whatever measure including legal action to bring any infringement of illegal use to an end.
- c) The Service Provider shall cooperate to provide Transnet promptly with all relevant ascertainable facts.
- d) If proceedings are commenced by Transnet alone, Transnet shall be responsible for all expenses but shall be entitled to all damages or other awards arising out of such proceedings. If proceedings are commenced by both Parties, both Parties will be responsible for the expenses and both Parties shall be entitled to damages or other awards arising out of proceedings.

14 SERVICE PROVIDER'S PERSONNEL

- 14.1 The Service Provider's Personnel shall be regarded at all times as employees, agents or Subcontractors of the Service Provider and no relationship of employer and employee shall arise between Transnet and any Service Provider Personnel under any circumstances regardless of the degree of supervision that may be exercised over the Personnel by Transnet.
- 14.2 The Service Provider warrants that all its Personnel will be entitled to work in South Africa or any other country in which the Services are to be performed.
- 14.3 The Service Provider will ensure that its Personnel comply with all reasonable requirements made known to the Service Provider by Transnet concerning conduct at any Transnet premises or any other premises upon which the Services are to be performed [including but not limited to security regulations, policy standards and codes of practice and health and safety requirements]. The Service Provider will ensure that such Personnel at all times act in a lawful and proper manner in accordance with these requirements.
- 14.4 Transnet reserves the right to refuse to admit or to remove from any premises occupied by or on behalf of it, any Service Provider Personnel whose admission or presence would, in the reasonable opinion of Transnet, be undesirable or who represents a threat to confidentiality or security or whose presence would be in breach of any rules and regulations governing Transnet's Personnel, provided that Transnet notifies the Service Provider of any such refusal [with reasons why]. The reasonable exclusion of any such individual from such premises shall not relieve the Service Provider from the performance of its obligations under the Agreement.
- 14.5 The Service Provider agrees to use all reasonable endeavours to ensure the continuity of its Personnel assigned to perform the Services. If any re-assignment by the Service Provider of those Personnel is necessary, or if Transnet advises that any such Personnel assigned are in any respect unsatisfactory, including where any such Personnel are, or are expected to be or have been absent for any period, then the Service Provider will promptly supply a replacement of equivalent

calibre and experience, and any such replacement shall be approved by Transnet prior to commencing provision of the Services, such approval not to be unreasonably withheld or delayed.

15 LIMITATION OF LIABILITY

15.1 Neither Party excludes or limits liability to the other Party for:

- a) death or personal injury due to negligence; or
- b) fraud.

15.2 The Service Provider shall indemnify and keep Transnet indemnified from and against liability for damage to any Transnet property [whether tangible or intangible] or any other loss, costs or damage suffered by Transnet to the extent that it results from any act or omission by the Service Provider or its Personnel in connection with the Agreement. The Service Provider's liability arising out of this clause 15.2 shall be limited to a maximum amount payable in respect of any one occurrence or a series of related occurrences in a single calendar year, such amount to be agreed in writing by the Parties.

15.3 Subject always to clauses 15.1 and 15.2 above, the liability of either the Service Provider or Transnet under or in connection with the Agreement, whether for negligence, misrepresentation, breach of contract or otherwise, for direct loss or damage arising out of each Default or series of related Defaults shall not exceed 100% [one hundred per cent] of the Fees paid under the schedule or Work Order to which the Default(s) relates.

15.4 Subject to clause 15.1 above, and except as provided in clauses 15.2 and 15.3 above, in no event shall either Party be liable to the other for indirect or consequential loss or damage or including indirect or consequential loss of profits, business, revenue, goodwill or anticipated savings of an indirect nature or loss or damage incurred by the other Party as a result of third party claims.

15.5 If for any reason the exclusion of liability in clause 15.4 above is void or unenforceable, either Party's total liability for all loss or damage under the Agreement shall be as provided in clause 15.3 above.

15.6 Nothing in this clause 15 shall be taken as limiting the liability of the Service Provider in respect of clauses 16 [Intellectual Property Rights] or clause 17 [Confidentiality].

16 INSURANCES

16.1 Without limiting the liability of the Service Provider under the Agreement, the Service Provider shall take out insurance in respect of all risks for which it is prudent for the Service Provider to insure against, including any liability it may have as a result of its activities under the Agreement for theft, destruction, death or injury to any person and damage to property. The level of insurance will be kept under review by Transnet, on an annual basis, to ensure its adequacy, provided that any variation to the level of such insurance shall be entirely at the discretion of the Service Provider.

16.2 The Service Provider shall arrange insurance with reputable insurers and will produce to Transnet evidence of the existence of the policies on an annual basis within 30 [thirty] days after date of policy renewals.

16.3 Subject to clause 16.4 below, if the Service Provider fails to effect adequate insurance under this clause 16, it shall notify Transnet in writing as soon as it becomes aware of the reduction or inadequate cover and Transnet may arrange or purchase such insurance. The Service Provider

shall promptly reimburse Transnet for any premiums paid provided such insurance protects the Service Provider's liability. Transnet assumes no responsibility for such insurance being adequate to protect all of the Service Provider's liability.

- 16.4 In the event that the Service Provider receives written notice from its insurers advising of the termination of its insurance cover referred to in clause 16.1 above or if the insurance ceases to be available upon commercially reasonable terms, the Service Provider shall immediately notify Transnet in writing of such termination and/or unavailability, whereafter either the Service Provider or Transnet may terminate the Agreement on giving the other Party not less than 30 [thirty] days prior written notice to that effect.

17 CONFIDENTIALITY

17.1 The Parties hereby undertake the following, with regard to Confidential Information:

- a) not to divulge or disclose to any person whomsoever in any form or manner whatsoever, either directly or indirectly, any Confidential Information of the other, without the prior written consent of such other Party, other than when called upon to do so in accordance with a statute, or by a court having jurisdiction, or by any other duly authorised and empowered authority or official, in which event the Party concerned shall do what is reasonably possible to inform the other of such a demand and each shall assist the other in seeking appropriate relief or the instituting of a defensive action to protect the Confidential Information concerned;
- b) not to use, exploit, permit the use of, directly or indirectly, or in any other manner whatsoever apply the Confidential Information, disclosed to it as a result of the Agreement, for any purpose whatsoever other than for the purpose for which it is disclosed or otherwise than in strict compliance with the provisions in the Agreement;
- c) not to make any notes, sketches, drawings, photographs or copies of any kind of any part of the disclosed Confidential Information, without the prior written consent of such other Party, except when reasonably necessary for the purpose of the Agreement, in which case such copies shall be regarded as Confidential Information;
- d) not to de-compile, disassemble or reverse engineer any composition, compilation, concept application, item, component de-compilation, including software or hardware disclosed and shall not analyse any sample provided by Transnet, or otherwise determine the composition or structure or cause to permit these tasks to be carried out except in the performance of its obligations pursuant to the Agreement;
- e) not to exercise less care to safeguard Transnet Confidential Information than the Party exercises in safeguarding its own competitive, sensitive or Confidential Information;
- f) Confidential Information disclosed by either Party to the other or by either Party to any other party used by such Party in the performance of the Agreement, shall be dealt with as "restricted" or shall be dealt with according to any other appropriate level of confidentiality relevant to the nature of the information concerned, agreed between the Parties concerned and stipulated in writing for such information in such cases;
- g) the Parties shall not make or permit to be made by any other person subject to their control, any public statements or issue press releases or disclose Confidential Information

with regard to any matter related to the Agreement, unless written authorisation to do so has first been obtained from the Party first disclosing such information;

- h) each Party shall be entitled to disclose such aspects of Confidential Information as may be relevant to one or more technically qualified employees or consultants of the Party who are required in the course of their duties to receive the Confidential Information for the Permitted Purpose provided that the employee or consultant concerned has a legitimate interest therein, and then only to the extent necessary for the Permitted Purpose, and is informed by the Party of the confidential nature of the Confidential Information and the obligations of the confidentiality to which such disclosure is subject and the Party shall ensure such employees or consultants honour such obligations;
- i) each Party shall notify the other Party of the name of each person or entity to whom any Confidential Information has been disclosed as soon as practicable after such disclosure;
- j) each Party shall ensure that any person or entity to which it discloses Confidential Information shall observe and perform all of the covenants the Party has accepted in the Agreement as if such person or entity has signed the Agreement. The Party disclosing the Confidential Information shall be responsible for any breach of the provisions of the Agreement by the person or entity; and
- k) each Party may by written notice to the other Party specify which of the Party's employees, officers or agents are required to sign a non-disclosure undertaking.

17.2 The duties and obligations with regard to Confidential Information in this clause 17 shall not apply where:

- a) a Party can demonstrate that such information is already in the public domain or becomes available to the public through no breach of the Agreement by that Party, or its Personnel; or
- b) was rightfully in a Party's possession prior to receipt from the other Party, as proven by the mentioned Party's written records, without an infringement of an obligation or duty of confidentiality; or
- c) can be proved to have been rightfully received by a Party from a third party without a breach of a duty or obligation of confidentiality; or
- d) is independently developed by a Party as proven by its written records.

17.3 This clause 17 shall survive termination for any reason of the Agreement and shall remain in force and effect from the Commencement Date of the Agreement and 5 [five] years after the termination of the Agreement. Upon termination of the Agreement, all documentation furnished to the Service Provider by Transnet pursuant to the Agreement shall be returned to Transnet including, without limitation all corporate identity equipment including dyes, blocks, labels, advertising matter, printing matter and the like.

18 TOTAL OR PARTIAL FAILURE TO PERFORM THE SCOPE OF SERVICES

Should the Service Provider fail or neglect to execute the work or to deliver any portion of the Service, as required by the terms of the Agreement or Work Order, Transnet may cancel the Agreement or Work Order in so far as it relates to the unexecuted work or rejected portion of the Service, and, in such event, the provision of any remaining commitment shall remain subject in all respects to these conditions.

19 TERM AND TERMINATION

- 19.1 Notwithstanding the date of signature hereof, the Commencement Date if the Agreement is [●] and the duration shall be for a [●] [[●]] year period, expiring on [●], unless:
- the Agreement is terminated by either Party in accordance with the provisions incorporated herein or in any schedules or annexures appended hereto, or otherwise in accordance with law or equity; or
 - the Agreement is extended at Transnet's option for a further period to be agreed by the Parties.
- 19.2 Either Party may terminate the Agreement forthwith by notice in writing to the other Party where the other Party has committed a material Default and, where such Default is capable of remedy, has failed to remedy such Default within 30 [thirty] days of receiving notice specifying the Default and requiring its remedy.
- 19.3 Either Party may terminate the Agreement forthwith by notice in writing to the other Party when the other Party is unable to pay its debts as they fall due or commits any act or omission which would be an act of insolvency in terms of the Insolvency Act, 24 of 1936 [as may be amended from time to time], or if any action, application or proceeding is made with regard to it for:
- a voluntary arrangement or composition or reconstruction of its debts;
 - its winding-up or dissolution;
 - the appointment of a liquidator, trustee, receiver, administrative receiver or similar officer; or
 - any similar action, application or proceeding in any jurisdiction to which it is subject.
- 19.4 Transnet may terminate the Agreement at any time within 2 [two] months of becoming aware of a change of control of the Service Provider by notice in writing to the Service Provider. For the purposes of this clause, "control" means the right to direct the affairs of a company whether by ownership of shares, membership of the board of directors, agreement or otherwise.
- 19.5 Transnet may cancel any schedule or Work Order hereto at any time on giving the Service Provider 30 [thirty] days' written notice.
- 19.6 Notwithstanding this clause 19, either Party may cancel the Agreement without cause by giving 30 [thirty] days prior written notice thereof to the other Party.

20 CONSEQUENCE OF TERMINATION

- 20.1 Termination in accordance with clause 19 [Term and Termination] shall not prejudice or affect any right of action or remedy which shall have accrued or shall thereafter accrue to either Party and all provisions which are to survive the Agreement or impliedly do so shall remain in force and in effect.
- 20.2 On termination of the Agreement or a Work Order, the Service Provider will immediately deliver up, and procure that its Personnel will immediately deliver up to Transnet, all Deliverables and property belonging to Transnet [or, in the event of termination of a Work Order, such as is relevant to that Work Order] which may be in the possession of, or under the control of the Service Provider, and certify to Transnet in writing that this has been done.
- 20.3 To the extent that any of the Deliverables and property referred to in clause 20.2 above are in electronic form and contained on non-detachable storage devices, the Service Provider will provide

Transnet with unencrypted copies of the same on magnetic media and will irretrievably destroy and delete copies so held.

20.4 In the event that the Agreement is terminated by the Service Provider under clause 19.2 [*Term and Termination*], or in the event that a Work Order is terminated by Transnet under clause 19.5 [*Term and Termination*], Transnet will pay to the Service Provider all outstanding Fees [apportioned on a *pro rata* basis] relating to the work undertaken by the Service Provider up until the date of such termination. Transnet will also pay the costs of any goods and materials ordered by the Service Provider in relation to the such work for which the Service Provider has paid or is legally obliged to pay, in which case, on delivery of such goods or materials, the Service Provider will promptly deliver such goods and materials to Transnet or as it may direct.

20.5 The provisions of clauses 1 [*Definitions*], 6 [*Warranties*], 13 [*Intellectual Property Rights*], 15 [*Limitation of Liability*], 17 [*Confidentiality*], 20 [*Consequence of Termination*], 26 [*Dispute Resolution*] and 30 [*Governing Law*] shall survive termination or expiry of the Agreement.

20.6 If either Party [**the Defaulting Party**] commits a material breach of the Agreement and fails to remedy such breach within 30 [thirty] Business Days of written notice thereof, the other Party [hereinafter **the Aggrieved Party**], shall be entitled, in addition to any other rights and remedies that it may have in terms of the Agreement, to terminate the Agreement forthwith without any liability and without prejudice to any claims which the Aggrieved Party may have for damages against the Defaulting Party.

20.7 Should:

- a) the Service Provider effect an attempt to effect a compromise or composition with its creditors; or
- b) either Party be provisionally or finally liquidated or placed under judicial management, whether provisionally or finally; or
- c) either Party cease or threaten to cease to carry on its normal line of business or default or threaten to default in the payment of its liabilities generally, or commit any act or omission which would be an act of insolvency in terms of the Insolvency Act, 24 of 1936 [as may be amended from time to time];

then the other Party shall be entitled, but not obliged, to terminate the Agreement on written notice, in which event such termination shall be without any liability and without prejudice to any claims which either Party may have for damages against the other.

21 ASSIGNMENT

Neither Party may assign the benefit of the Agreement or any interest hereunder except with the prior written consent of the other. Further, in the event that Transnet wishes to assign or novate the Agreement to any third party, the Service Provider agrees that it shall not unreasonably withhold or delay its consent to such assignment or novation and that it shall only be entitled to recover from Transnet any reasonable legal costs incurred by it as a direct result of such assignment or novation.

22 FORCE MAJEURE

22.1 Neither Party shall have any claim against the other Party arising from any failure or delay in the performance of any obligation of either Party under the Agreement caused by an act of *force majeure* such as acts of God, fire, flood, war, lockout, government action, laws or regulations, terrorism or civil disturbance, defaults or other circumstances or factors beyond the reasonable

control of either Party, and to the extent that the performance of obligations of either Party hereunder is delayed by virtue of the foregoing, any period stipulated for any such performance shall be reasonably extended. Transnet may however rely on strikes, industrial dispute and riots as a ground of *force majeure*.

- 22.2 Each Party will take all reasonable steps by whatever lawful means that are available, to resume full performance as soon as practicable and will seek agreement to modification of the relevant provisions of the Agreement in order to accommodate the new circumstances caused by the act of *force majeure*. If a Party fails to agree to such modifications proposed by the other Party within 90 [ninety] days of the act of *force majeure* first occurring, either Party may thereafter terminate the Agreement with immediate notice.

23 EQUALITY AND DIVERSITY

- 23.1 The Service Provider will not victimise, harass or discriminate against any employee of either Party to the Agreement or any applicant for employment with either Party to the Agreement due to their gender, race, disability, age, religious belief, sexual orientation or part-time status. This provision applies, but is not limited to employment, upgrading, work environment, demotion, transfer, recruitment, recruitment advertising, termination of employment, rates of pay or other forms of compensation and selection for training.
- 23.2 Both Parties to the Agreement undertake that they will not, and shall procure that its employees, agents and Subcontractors will not breach any applicable discrimination legislation and any amendments and re-enactments thereof.

24 NON-WAIVER

- 24.1 Failure or neglect by either Party, at any time, to enforce any of the provisions of the Agreement, shall not, in any manner, be construed to be a waiver of any of that Party's rights in that regard and in terms of the Agreement.
- 24.2 Such failure or neglect shall not, in any manner, affect the continued, unaltered validity of the Agreement, or prejudice the right of that Party to institute subsequent action.

25 PARTIAL INVALIDITY

If any provision of the Agreement shall be held to be invalid, illegal or unenforceable, or shall be required to be modified, the validity, legality and enforceability of the remaining provisions shall not be affected thereby.

26 DISPUTE RESOLUTION

- 26.1 Should any dispute of whatsoever nature arise between the Parties concerning the Agreement, the Parties shall try to resolve the dispute by negotiation within 10 [ten] Business Days of such dispute arising.
- 26.2 If the dispute has not been resolved by such negotiation, either of the Parties may refer the dispute to AFSA and notify the other Party accordingly, which proceedings shall be held in Johannesburg.
- 26.3 Such dispute shall be finally resolved in accordance with the rules of AFSA by an arbitrator or arbitrators appointed by AFSA.

- 26.4 This clause constitutes an irrevocable consent by the Parties to any proceedings in terms hereof, and neither of the Parties shall be entitled to withdraw from the provisions of this clause or claim at any such proceedings that it is not bound by this clause 26.
- 26.5 This clause 26 is severable from the rest of the Agreement and shall remain in effect even if the Agreement is terminated for any reason.
- 26.6 This clause 26 shall not preclude either Party from seeking urgent relief in a court of appropriate jurisdiction, where grounds for urgency exist.

27 ADDRESSES FOR NOTICES

27.1 The Parties to the Agreement select the physical addresses and facsimile numbers, as detailed hereafter, as their respective addresses for giving or sending any notice provided for or required in terms of the Agreement, provided that either Party shall be entitled to substitute such other address or facsimile number, as may be, by written notice to the other:

a) **Transnet**

(i) For legal notices: [•]
Fax No. [•]
Attention: Legal Counsel

(ii) For commercial matters: [•]
Fax No. [•]
Attention: [•]

b) **The Service Provider**

(i) For legal notices: [•]
Fax No. [•]
Attention: [•]

(ii) For commercial matters: [•]
Fax No. [•]
Attention: [•]

27.2 Any notice shall be addressed to a Party at its physical address or delivered by hand, or sent by facsimile.

27.3 Any notice shall be deemed to have been given:

- a) if hand delivered, on the day of delivery; or
- b) if posted by prepaid registered post, 10 [ten] days after the date of posting thereof; or
- c) if faxed, on the date and time of sending of such fax, as evidenced by a fax confirmation printout, provided that such notice shall be confirmed by prepaid registered post on the date of dispatch of such fax, or, should no postal facilities be available on that date, on the next Business Day.

28 WHOLE AND ONLY AGREEMENT

- 28.1 The Parties hereby confirm that the Agreement constitutes the whole and only agreement between them with regard to the subject matter of the Agreement.
- 28.2 The Parties hereby confirm that the Agreement replaces all other agreements which exist or may have existed in any form whatever between them, with regard to the subject matter dealt with in the Agreement, including any annexures, appendices, schedules or Work Order(s) appended hereto.

29 AMENDMENT AND CHANGE CONTROL

- 29.1 Any requirement for an amendment or change to the Agreement or to a Work Order shall only be valid if it is in writing, signed by both Parties and added to the Agreement as an addendum hereto.
- 29.2 In the event the Parties cannot agree upon changes, the Parties shall in good faith seek to agree any proposed changes using the dispute resolution procedures in clause 26 [*Dispute Resolution*].

30 GOVERNING LAW

The Agreement is exclusively governed by and construed in accordance with the laws of the Republic of South Africa and is subject to the jurisdiction of the courts of the Republic of South Africa.

30.1 Change of Law

In the Agreement, unless the context otherwise requires, references to a statutory provision include references to that statutory provision as from time to time amended, extended or re-enacted and any regulations made under it, provided that in the event that the amendment, extension or re-enactment of any statutory provision or introduction of any new statutory provision has a material impact on the obligations of either Party, the Parties will negotiate in good faith to agree such amendments to the Agreement as may be appropriate in the circumstances. If within a reasonable period of time, the Service Provider and Transnet cannot reach agreement on the nature of the changes required or on modification of Fees, Deliverables, warranties, or other terms and conditions, either Party may seek to have the matter determined in accordance with clause 26 [*Dispute Resolution*] above.

31 COUNTERPARTS

The Agreement may be signed in any number of counterparts, all of which taken together shall constitute one and the same instrument. Either Party may enter into the Agreement by signing any such counterpart.

oooOOOooo

TRANSNET LIMITED

(Registration no. 1990/000900/30)

**SAFETY ARRANGEMENTS AND PROCEDURAL COMPLIANCE
WITH THE OCCUPATIONAL HEALTH AND SAFETY ACT
(ACT 85 OF 1993) AND APPLICABLE REGULATIONS****1. General**

- 1.1 The Contractor and Transnet Limited (hereinafter referred to as "Transnet") are individual employers, each in its own right, with their respective duties and obligations set out in the Occupational Health and Safety Act, Act 85 of 1993 (the Act) and applicable Regulations.
- 1.2 The Contractor accepts, in terms of the General Conditions of Contract and in terms of the Act, his obligations as an employer in respect of all persons in his employ, other persons on the premises or the Site or place of work or on the work to be executed by him, and under his control. He shall, before commencement with the execution of the contract work, comply with the provisions set out in the Act, and shall implement and maintain a Health and Safety Plan as described in the Construction Regulations, 2003 and as approved by Transnet, on the Site and place of work for the duration of the Contract.
- 1.3 The Contractor accepts his obligation to complying fully with the Act and applicable Regulations notwithstanding the omission of some of the provisions of the Act and the Regulations from this document.
- 1.4 Transnet accepts, in terms of the Act, its obligations as an employer of its own employees working on or associated with the site or place of work, and the Contractor and Technical Officer or his deputy shall at all times, co-operate in respect of the health and safety management of the site, and shall agree on the practical arrangements and procedures to be implemented and maintained during execution of the Works.
- 1.5 In the event of any discrepancies between any legislation and this specification, the applicable legislation will take precedence.

2. Definitions

- 2.1 In this Specification any word or expression to which a meaning has been assigned in the Construction Regulations, shall have the meaning so assigned to it, unless the context otherwise indicates: -
- 2.2 The work included in this Contract shall for the purposes of compliance with the Act be deemed to be "**Construction Work**", which, in terms of the Construction Regulations, 2003 means any work in connection with: -
- (a) the erection, maintenance, alteration, renovation, repair, demolition or dismantling of or addition to a building or any similar structure;

- (b) the installation, erection, dismantling or maintenance of fixed plant where such work includes the risk of a person falling;
 - (c) the construction, maintenance, demolition or dismantling of any bridge, dam, canal, road, railway, runway, sewer or water reticulation system or any similar civil engineering structure; or
 - (d) the moving of earth, clearing of land, the making of an excavation, piling, or any similar type of work;
- 2.3 **“competent person”** in relation to construction work, means any person having the knowledge, training and experience specific to the work or task being performed: Provided that where appropriate qualifications and training are registered as per the South African Qualifications Authority Act, 1995 these qualifications and training shall be deemed to be the required qualifications and training;
- 2.4 **“contractor”** means principal contractor and **“subcontractor”** means contractor as defined by the Construction Regulations, 2003.
- 2.5 **“fall protection plan”** means a documented plan, of all risks relating to working from an elevated position, considering the nature of work undertaken, and setting out the procedures and methods applied to eliminate the risk;
- 2.6 **“health and safety file”** means a file, or other record in permanent form, containing the information required to be kept on site in accordance with the Act and applicable Regulations;
- 2.7 **“Health and Safety Plan”** means a documented plan which addresses the hazards identified and includes safe work procedures to mitigate, reduce or control the hazards identified;
- 2.8 **“Risk Assessment”** means a programme to determine any risk associated with any hazard at a construction site, in order to identify the steps needed to be taken to remove, reduce or control such hazard;
- 2.9 **“the Act”** means the Occupational Health and Safety Act No. 85 of 1993.

3. Procedural Compliance

3.1 The Contractor who intends to carry out any construction work shall, before carrying out such work, notify the Provincial Director in writing if the construction work:-

- (a) includes the demolition of a structure exceeding a height of 3 metres; or
- (b) includes the use of explosives to perform construction work; or
- (c) includes the dismantling of fixed plant at a height greater than 3m,

and shall also notify the Provincial Director in writing when the construction work exceeds 30 days or will involve more than 300 person days of construction work and if the construction work:-

- (a) includes excavation work deeper than 1m; or

- (b) includes working at a height greater than 3 metres above ground or a landing.
- 3.2 The notification to the Provincial Director shall be on a form similar to Annexure A of the Construction Regulations, 2003, also shown in Annexure 1 of this Specification. The Contractor shall ensure that a copy of the completed notification form is kept on site for inspection by an inspector, Technical Officer or employee.
- 3.3 The Contractor shall, in accordance with the Act and applicable Regulations, make all the necessary appointments of competent persons in writing on a form similar to Annexure 2 of this Specification and deliver copies thereof to the Technical Officer. Copies should also be retained on the health and safety file.
- 3.4 Subcontractors shall also make the above written appointments and the Contractor shall deliver copies thereof to the Technical Officer.
- 3.5 In the case of a self-employed Contractor or any subcontractor who has the appropriate competencies and supervises the work himself, the appointment of a construction supervisor in terms of regulation 6.1 of the Construction Regulations, 2003 will not be necessary. The Contractor shall in such a case execute and sign a declaration, as in Annexure 3, by which he personally undertakes the duties and obligations of the "Chief Executive Officer" in terms of section 16(1) of the Act.
- 3.6 The Contractor shall, before commencing any work, obtain from the Technical Officer an access certificate as in Annexure 4 executed and signed by him, permitting and limiting access to the designated site or place of work by the Contractor and any subcontractors under his control.
- 3.7 Procedural compliance with Act and Regulations, as above, shall also apply to any subcontractors as employers in their own right. The Contractor shall furnish the Technical Officer with full particulars of such subcontractors and shall ensure that they comply with the Act and Regulations and Protekon's safety requirements and procedures.

4. **Special Permits**

Where special permits are required before work may be carried out such as for hotwork, isolation permits, work permits and occupations, the Contractor shall apply to the Technical Officer or the relevant authority for such permits to be issued. The Contractor shall strictly comply with the conditions and requirements pertaining to the issue of such permits.

5. **Health and Safety Programme**

- 5.1 The Tenderer shall, with his tender, submit a Health and Safety Programme setting out the practical arrangements and procedures to be implemented by him to ensure compliance by him with the Act and Regulations and particularly in respect of: -
- (i) The provision, as far as is reasonably practical, of a working environment that is safe and without risk to the health of his employees and subcontractors in terms of section 8 of the Act;

- (ii) the execution of the contract work in such a manner as to ensure in terms of section 9 of the Act that persons other than those in the Contractor's employment, who may be directly affected by the contract work are not thereby exposed to hazards to their health and safety;
 - (iii) ensuring, as far as is reasonably practical, in terms of section 37 of the Act that no employee or subcontractor of the Contractor does or omits to do any act which would be an offence for the Contractor to do or omit to do.
- 5.2 The Contractor's Health and Safety Programme shall be based on a risk assessment in respect of the hazards to health and safety of his employees and other persons under his control that are associated with or directly affected by the Contractor's activities in performing the contract work and shall establish precautionary measures as are reasonable and practical in protecting the safety and health of such employees and persons.
- 5.3 The Contractor shall cause a risk assessment contemplated in clause 5.2 above to be performed by a competent person, appointed in writing, before commencement of any Construction Work and reviewed during construction. The Risk Assessments shall form part of the Health and Safety programme to be applied on the site and shall include at least the following:
- (a) The identification of the risks and hazards that persons may be exposed to;
 - (b) the analysis and evaluation of the hazards identified;
 - (c) a documented Health and Safety Plan, including safe work procedures to mitigate, reduce or control the risks identified;
 - (d) a monitoring and review plan.
- 5.4 The Health and Safety Plan shall include full particulars in respect of: -
- (a) The safety management structure to be instituted on site or place of work and the names of the Contractor's health and safety representatives and members of safety committees where applicable;
 - (b) the safe working methods and procedures to be implemented to ensure the work is performed in compliance with the Act and Regulations;
 - (c) the safety equipment, devices and clothing to be made available by the Contractor to his employees;
 - (d) the site access control measures pertaining to health and safety to be implemented;
 - (e) the arrangements in respect of communication of health and safety related matters and incidents between the Contractor, his employees, subcontractors and the Technical Officer with particular reference to the reporting of incidents in compliance with Section 24 and General Administrative Regulation 8 of the Act and with the pertinent clause of the General Conditions of Contract forming part of the Contract and

- (f) the introduction of control measures for ensuring that the Safety Plan is maintained and monitored for the duration of the Contract.
- 5.4 The Health and Safety programme shall be subject to the Technical Officer's approval and he may, in consultation with the Contractor, order that additional and/or supplementary practical arrangements and procedures be implemented and maintained by the Contractor or that different working methods or safety equipment be used or safety clothes be issued which, in the Technical Officer's opinion, are necessary to ensure full compliance by the Contractor with his obligations as an employer in terms of the Act and Regulations. The Technical Officer or his deputy shall be allowed to attend meetings of the Contractor's safety committee as an observer.
- 5.5 The Contractor shall take reasonable steps to ensure that each subcontractor's Health and Safety Plan is implemented and maintained on the construction site: Provided that the steps taken, shall include periodic audits at intervals mutually agreed to between the them, but at least once every month.
- 5.6 The Contractor shall stop any subcontractor from executing any construction work, which is not in accordance with the Contractor's and/or subcontractor's Health and Safety Plan for the site or which poses a threat to the health and safety of persons.
- 5.7 The Contractor shall ensure that a copy of the Health and Safety Plan is available on site for inspection by an inspector, Technical Officer, agent, subcontractor, employee, registered employee organisation, health and safety representative or any member of the health and safety committee.
- 5.8 The Contractor shall consult with the health and safety committee or, if no health and safety committee exists, with a representative group of employees, on the development, monitoring and review of the Risk Assessment.
- 5.9 The Contractor shall ensure that all employees under his control are informed, instructed and trained by a competent person regarding any hazard and the related work procedures before any work commences, and thereafter at such times as may be determined in the Risk Assessment.
- 5.10 The Contractor shall ensure that all subcontractors are informed regarding any hazard as stipulated in the Risk Assessment before any work commences, and thereafter at such times as may be determined in the Risk Assessment.
- 5.11 The Contractor shall ensure that all visitors to a construction site undergoes health and safety induction pertaining to the hazards prevalent on the site and shall be provided with the necessary personal protective equipment.
- 6. Fall Protection Plan**
- 6.1 In the event of the risk and hazard identification, as required in terms of clause 5.3 of this Specification, revealing risks relating to working from an elevated position the contractor shall cause the designation of a competent person, responsible for the preparation of a fall protection plan;

6.2 The Contractor shall implement, maintain and monitor the fall protection plan for the duration of Contract. The Contractor shall also take such steps to ensure the continued adherence to the fall protection plan.

6.3 The fall protection plan shall include:-

- (a) A Risk Assessment of all work carried out from an elevated position;
- (b) the procedures and methods to address all the identified risks per location;
- (c) the evaluation of the employees physical and psychological fitness necessary to work at elevated positions;
- (d) the training of employees working from elevated positions; and
- (e) the procedure addressing the inspection, testing and maintenance of all fall protection equipment.

7. Hazards and Potential Hazardous Situations

The Contractor and the Technical Officer shall immediately notify one another of any hazardous or potentially hazardous situations which may arise during performance of the Contract by the Contractor or any subcontractor and, in particular, of such hazards as may be caused by the design, execution and/or location and any other aspect pertaining to the contract work.

8. Health and Safety File

- 8.1 The Contractor shall ensure that a health and safety file is opened and kept on site and shall include all documentation required as per the Act and applicable regulations, and made available to an Inspector, the Technical Officer, or subcontractor upon request.
- 8.2 The Contractor shall ensure that a copy of the both his Health and Safety Plan as well as any subcontractor's Health and Safety Plan is available on request to an employee, inspector, contractor or the Technical Officer.
- 8.3 The Contractor shall hand over a consolidated health and safety file to the Technical Officer upon completion of the Construction Work and shall in addition to documentation mentioned in the Act and applicable Regulations include a record of all drawings, designs, materials used and other similar information concerning the completed structure.

ANNEXURE 1**OCCUPATIONAL HEALTH AND SAFETY ACT, 1993****Regulation 3(1) of the Construction Regulations****NOTIFICATION OF CONSTRUCTION WORK**

-
-
- 1(a) Name and postal address of principal contractor:

- (b) Name and tel. no of principal contractor's contact person:

2. Principal contractor's compensation registration number: _____
- 3.(a) Name and postal address of client:

- (b) Name and tel no of client's contact person or agent:

- 4.(a) Name and postal address of designer(s) for the project:

- (b) Name and tel. no of designer(s) contact person:

5. Name and telephone number of principal contractor's construction supervisor on site appointed in terms of regulation 6(1).

6. Name(s) of principal contractor's construction sub-ordinate supervisors on site appointed in terms of regulation 6(2).

7. Exact physical address of the construction site or site office:

8. Nature of the construction work:

9. Expected commencement date: _____
10. Expected completion date: _____

11. Estimated maximum number of persons on the construction site: _____

12. Planned number of contractors on the construction site accountable to the principle contractor:

13. Name(s) of contractors already chosen.

Principal Contractor

Date

Client

Date

* THIS DOCUMENT IS TO BE FORWARDED TO THE OFFICE OF THE DEPARTMENT OF LABOUR PRIOR TO COMMENCEMENT OF WORK ON SITE.

* ALL PRINCIPAL CONTRACTORS THAT QUALIFY TO NOTIFY MUST DO SO EVEN IF ANOTHER PRINCIPAL CONTRACTOR ON THE SAME SITE HAD DONE SO PRIOR TO THE COMMENCEMENT OF WORK.

"PREVIEW COPY ONLY"

ANNEXURE 2

(COMPANY LETTER HEAD)

OCCUPATIONAL HEALTH AND SAFETY ACT, 1993 (ACT 85 OF 1993) :

SECTION/REGULATION: _____

REQUIRED COMPETENCY: _____

In terms of _____ I, _____

representing the Employer) do hereby appoint _____

As the Competent Person on the premises at _____

(physical address) to assist in compliance with the Act and the applicable Regulations.

Your designated area/s is/are as follows :-

Date : _____

Signature :- _____

Designation :- _____

ACCEPTANCE OF DESIGNATION

I, _____ do hereby accept this Designation and acknowledge that I understand the requirements of this appointment.

Date : _____

Signature :- _____

Designation :- _____

"PREVIEW COPY ONLY"

ANNEXURE 3**(COMPANY LETTER HEAD)****OCCUPATIONAL HEALTH AND SAFETY ACT, 1993 (ACT 85 OF 1993) :****DECLARATION**

In terms of the above Act I, _____ am personally assuming the duties and obligations as Chief Executive Officer, defined in Section 1 of the Act and in terms of Section 16(1), I will, as far as is reasonably practicable, ensure that the duties and obligations of the Employer as contemplated in the above Act are properly discharged.

Signature :- _____

Date : _____

"PREVIEW COPY ONLY"

ANNEXURE 4

(LETTER HEAD OF BUSINESS DIVISION OR UNIT OF TRANSNET LIMITED)

SITE ACCESS CERTIFICATE

Access to : _____ (Area)
Name of Contractor/Builder :- _____
Contract/Order No.: _____

The contract works site/area described above are made available to you for the carrying out of associated works

In terms of your contract/order with
(company) _____

Kindly note that you are at all times responsible for the control and safety of the Works Site, and for persons under your control having access to the site.

As from the date hereof you will be responsible for compliance with the requirements of the Occupational Health and Safety Act, 1993 (Act 85 of 1993) as amended, and all conditions of the Contract pertaining to the site of the works as defined and demarcated in the contract documents including the plans of the site or work areas forming part thereof.

Signed : _____ Date : _____
TECHNICAL OFFICER

"PREVIEW COPY ONLY"

ACKNOWLEDGEMENT OF RECEIPT

Name of Contractor/Builder :- _____ I,
_____ do hereby acknowledge and accept the duties
and obligations in respect of the Safety of the site/area of Work in terms of the Occupational Health and
Safety Act; Act 85 of 1993.

Name : _____ Designation : _____

Signature : _____ Date : _____

TRANSNET

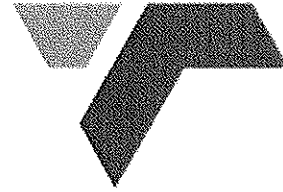

Transnet SOC Limited Registration Number 1990/00900/06

TRANSNET SPECIFICATION

**E7/1 - SPECIFICATION FOR GENERAL WORK AND
WORKS ON, OVER, UNDER OR ADJACENT TO RAILWAY
LINES AND NEAR HIGH VOLTAGE EQUIPMENT**

(This specification shall be used in network operator contracts)







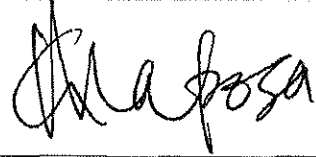

"PREVIEW COPY ONLY"

Circulation Not Restricted

© This document as a whole is protected by copyright. The information herein is the sole property of Transnet SOC Ltd. It may not be used, disclosed or reproduced in part or in whole in any manner whatsoever, except with the written permission of and in a manner permitted by the proprietors.

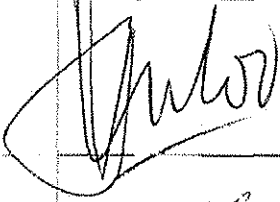
(This page not to be issued with contract)

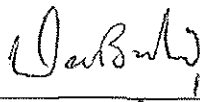
SPECIFICATION FOR GENERAL WORK AND WORKS ON, OVER, UNDER OR ADJACENT TO RAILWAY LINES AND NEAR HIGH VOLTAGE EQUIPMENT

Author:	Project Manager Capital Program (Electrical)	G. Maposa	
Approved:	Senior Engineer Infra Engineering (Train Authorisation Systems)	J. van den Berg	
"	Principal Engineer Infra Engineering (Track)	M. Marutla	
"	Principal Engineer Infra Engineering (Structures)	J. Hohan	
"	Principal Engineer Infra Engineering (Electrical)	J. Vosloo	
"	Principal Engineer Technology Management (Electrical)	W. Coetzee	
"	Chief Engineer Transport Telecoms	D. Botha	 17 June 11
Authorised:	Chief Engineer Infrastructure Engineering	J. van Aardt	 2011/06/30

"PREVIEW COPY ONLY"

Date: May 2011

(This page not to be issued with contract)

TRANSNET

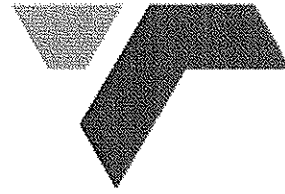

Transnet SOC Limited Registration Number 1990/00900/06

TRANSNET SPECIFICATION

**E7/1 - SPECIFICATION FOR GENERAL WORK AND
WORKS ON, OVER, UNDER OR ADJACENT TO RAILWAY
LINES AND NEAR HIGH VOLTAGE EQUIPMENT**

(This specification shall be used in network operator contracts)

"PREVIEW COPY ONLY"

Circulation Not Restricted

© This document as a whole is protected by copyright. The information herein is the sole property of Transnet SOC Ltd. It may not be used, disclosed or reproduced in part or in whole in any manner whatsoever, except with the written permission of and in a manner permitted by the proprietors.

CONTENTS

<u>CLAUSE</u>	<u>HEADING</u>	<u>PAGE</u>
1.0	SCOPE	3
2.0	DEFINITIONS	3
PART A - GENERAL SPECIFICATION		
3.0	AUTHORITY OF OFFICERS OF TRANSNET	4
4.0	CONTRACTOR'S REPRESENTATIVES AND STAFF	4
5.0	OCCUPATIONS AND WORK PERMITS	4
6.0	SPEED RESTRICTIONS AND PROTECTION	5
7.0	ROADS ON THE NETWORK OPERATOR'S PROPERTY	5
8.0	CLEARANCES	5
9.0	STACKING OF MATERIAL	5
10.0	EXCAVATION, SHORING, DEWATERING AND DRAINAGE	5
11.0	FALSEWORK FOR STRUCTURES	6
12.0	PILING	6
13.0	UNDERGROUND SERVICES	6
14.0	BLASTING AND USE OF EXPLOSIVES	6
15.0	RAIL TROLLEYS	7
16.0	SIGNAL TRACK CIRCUITS	7
17.0	PENALTY FOR DELAYS TO TRAINS	7
18.0	SURVEY BEACONS AND PEGS	7
19.0	TEMPORARY LEVEL CROSSINGS	8
20.0	COMPLETION OF THE WORKS	8
21.0	PROTECTION OF PERSONS AND PROPERTY	9
22.0	INTERFERENCE WITH THE NETWORK OPERATOR'S ASSETS AND WORK ON OPEN LINES	10
23.0	ACCESS, RIGHTS OF-WAY AND CAMPSITES	10
24.0	SUPERVISION	10
25.0	HOUSING OF EMPLOYEES	10
26.0	OPTICAL FIBRE CABLE ROUTES	10
PART B - ADDITIONAL SPECIFICATION FOR WORK NEAR HIGH-VOLTAGE ELECTRICAL EQUIPMENT		
27.0	GENERAL	11
28.0	WORK ON BUILDINGS OR FIXED STRUCTURES	11
29.0	WORK DONE ON OR OUTSIDE OF ROLLING STOCK, INCLUDING LOADING AND UNLOADING	11
30.0	USE OF EQUIPMENT	12
31.0	CARRYING AND HANDLING MATERIAL AND EQUIPMENT	12
32.0	PRECAUTIONS TO BE TAKEN WHEN ERECTING OR REMOVING POLES, ANTENNAE AND TREES ETC.	12
33.0	USE OF WATER	13
34.0	USE OF CONSTRUCTION PLANT	13
35.0	WORK PERFORMED UNDER DEAD CONDITIONS UNDER COVER OF A WORK PERMIT	13
36.0	TRACTION RETURN CIRCUITS IN RAILS	13
37.0	HIGH-VOLTAGE ELECTRICAL EQUIPMENT NOT MAINTAINED AND/OR OPERATED BY THE NETWORK OPERATOR	14

1.0 SCOPE

- 1.1 This specification covers the network operator's requirements for general work and works on, over, under or adjacent to railway lines and near high voltage equipment.

2.0 DEFINITIONS

The following definitions shall apply:

"Authorised Person" - A person whether an employee of the network operator or not, who has been specially authorised to undertake specific duties in terms of Transnet's publication Electrical Safety Instructions, and who holds a certificate or letter of authority to that effect.

"Barrier" Any device designed to restrict access to "live" high-voltage electrical equipment.

"Bond" - A short conductor installed to provide electrical continuity.

"Contractor" - Any person or organisation appointed by the network operator to carry out work on its behalf.

"Contract Supervisor" - The person or juristic person appointed by the network operator from time to time as the Contract Supervisor, to administer the Contractor's performance and execution of the Works according to the powers and rights held by and obligations placed upon the Contract Supervisor in terms of the Contract.

"Dead" - Isolated and earthed.

"Electrical Officer (Contracts)" - The person appointed in writing by the Project Manager in terms of this specification as the person who shall be consulted by the Contractor in all electrical matters to ensure that adequate safety precautions are taken by the Contractor.

"Executive Officer" - The person appointed by the network operator from time to time as the Executive Officer to act according to the rights and powers held by and obligations placed upon him in terms of the Contract.

"High-Voltage" - A voltage normally exceeding 1000 volts.

"Live" - A conductor is said to be "live" when it is at a potential different from that of the earth or any other conductor of the system of which it forms a part.

"Near" - To be in such a position that a person's body or the tools he is using or any equipment he is handling may come within 2 metres of "live" exposed high-voltage electrical equipment.

"Occupation" - An authorisation granted by the network operator for work to be carried out under specified conditions on, over, under or adjacent to railway lines.

"Occupation Between Trains" - An occupation during an interval between successive trains.

"Optical Fibre Cable" - Buried or suspended composite cable containing optical fibres used in:

- telecommunication networks for transmission of digital information and
- safety sensitive train operations systems.

"Project Manager" - As defined in the special conditions of the contract. The person or juristic person appointed by the network operator from time to time as the Project Manager, to administer the Contract according to the powers and rights held by and obligations placed upon him in terms of the Contract.

"Responsible Representative" - The responsible person in charge, appointed by a contractor, who has undergone specific training (and holds a certificate) to supervise (general or direct) staff under his control who perform general work or to work on, over, under or adjacent to railway lines and in the vicinity of high-voltage electrical equipment.

"Total Occupation" - An occupation for a period when trains are not to traverse the section of line covered by the occupation.

"Work on" - Work undertaken on or so close to the equipment that the specified working clearances to the "live" equipment cannot be maintained.

"Work Permit" - A combined written application and authority to proceed with work on or near dead electrical equipment.

"Works" - The contractual intent for the work to be done as defined in the contract at a defined work site.

PART A - GENERAL SPECIFICATION**3.0 AUTHORITY OF OFFICERS OF TRANSNET**

- 3.1 The Contractor shall co-operate with the officers of the network operator and shall comply with all instructions issued and restrictions imposed with respect to the Works which bear on the existence and operation of the network operator's railway lines and high-voltage equipment.
- 3.2 Without limiting the generality of the provisions of clause 3.1, any duly authorised representative of the network operator, having identified himself, may stop the work if, in his opinion, the safe passage of trains or the safety of the network operator's assets or any person is affected. **CONSIDERATIONS OF SAFETY SHALL TAKE PRECEDENCE OVER ALL OTHER CONSIDERATIONS.**

4.0 CONTRACTOR'S REPRESENTATIVES AND STAFF

- 4.1 The Contractor shall nominate Responsible Representatives of whom at least one shall be available at any hour for call-out in cases of emergency. The Contractor shall provide the Contract Supervisor with the names, addresses and telephone numbers of the representatives.
- 4.2 The Contractor guarantees that he has satisfied himself that the Responsible Representative is fully conversant with this specification and that he shall comply with all his obligations in respect thereof.
- 4.3 The Contractor shall ensure that all contractor staff receives relevant awareness, educational and competence training regarding safety as prescribed.

5.0 OCCUPATIONS AND WORK PERMITS

- 5.1 Work to be done during total occupation or during an occupation between trains or under a work permit shall be done in a manner decided by the Contract Supervisor and at times to suit the network operator requirements.
- 5.2 The Contractor shall organise the Works in a manner which will minimise the number and duration of occupations and work permits required.
- 5.3 The network operator will not be liable for any financial or other loss suffered by the Contractor arising from his failure to complete any work scheduled during the period of an occupation or work permit.
- 5.4 The Contractor shall submit to the Contract Supervisor, in writing, requests for occupations or work permits together with details of the work to be undertaken, at least 21 days before they are required. The network operator does not undertake to grant an occupation or work permit for any particular date, time or duration.
- 5.5 The network operator reserves the right to cancel any occupation or work permit at any time before or during the period of occupation or work permit. If, due to cancellation or change in date or time, the Contractor is not permitted to start work under conditions of total occupation or work permit at the time arranged, all costs caused by the cancellation shall be born by the Contractor except as provided for in clauses 5.6 to 5.8.
- 5.6 When the Contractor is notified less than 2 hours before the scheduled starting time that the occupation or work permit is cancelled, he may claim reimbursement of his direct financial losses caused by the loss of working time up to the time his labour and plant are employed on other work, but not exceeding the period of the cancelled occupation or work permit.
- 5.7 When the Contractor is notified less than 2 hours before the scheduled starting time, or during an occupation or work permit, that the duration of the occupation or work permit is reduced, he may claim reimbursement of his direct financial losses caused by the loss of working time due to the reduced duration of the occupation or work permit.
- 5.8 Reimbursement of the Contractor for any loss of working time in terms of clause 5.6 and 5.7, shall be subject to his claims being submitted within 14 days of the event with full details of labour and plant involved, and provided that the Contract Supervisor certifies that no other work on which the labour and plant could be employed was immediately available.
- 5.9 Before starting any work for which an occupation has been arranged, the Contractor shall obtain from the Contract Supervisor written confirmation of the date, time and duration of the occupation.
- 5.10 Before starting any work for which a work permit has been arranged, the Responsible Representative shall read and sign portion C of the Work Permit, signifying that he is aware of the work boundaries within which work may be undertaken. After the work for which the permit was granted has been completed, or when the

work permit is due to be terminated, or if the permit is cancelled after the start, the same person who signed portion C shall sign portion D of the Work Permit, thereby acknowledging that he is aware that the electrical equipment is to be made "live". The Contractor shall advise all his workmen accordingly.

6.0 SPEED RESTRICTIONS AND PROTECTION

- 6.1 When speed restrictions are imposed by the network operator because of the Contractor's activities, the Contractor shall organise and carry out his work so as to permit the removal of the restrictions as soon as possible.
- 6.2 When the Contract Supervisor considers protection to be necessary the Contractor shall, unless otherwise agreed, provide all protection including flagmen, other personnel and all equipment for the protection of the network operator's and the Contractor's personnel and assets, the public and including trains.
- 6.2.1 The network operator will provide training free of charge of the Contractor's flagmen and other personnel performing protection duties. The Contractor shall consult with the Contract Supervisor, whenever he considers that protection will be necessary, taking into account the minimum permissible clearances set out in the Manual for Track Maintenance (Document no. BBB0481):
- Drawing no. BE-97 Sheet 1: Horizontal Clearances: 1065mm gauge (Annexure 1 sheet 1)
 - Drawing no. BE-97 Sheet 2: Vertical Clearances: 1065mm gauge (Annexure 1 sheet 2)
 - Drawing no. BE-97 Sheet 3: Clearances: Platform (Annexure 1 sheet 3)
 - Drawing no. BE-97 Sheet 5: Clearances: 610mm Gauge (Annexure 1 sheet 5)
- 6.3 The Contractor shall appoint a Responsible Representative to receive and transmit any instruction which may be given by the network operator personnel providing protection.

7.0 ROADS AND ROADS ON THE NETWORK OPERATOR'S PROPERTY

- 7.1 The Contractor shall take every reasonable precaution to prevent damage to any roads or bridges used to obtain access to the site, and shall select routes, use vehicles, and restrict loads so that any extraordinary traffic as may arise from the moving of plant or material to or from the site shall be limited as far as is reasonably possible.
- 7.2 The Contractor shall not occupy or interfere in any way with the free use of any public or private road, right-of-way, path or street unless the Contract Supervisor has obtained the approval of the road authority concerned.

8.0 CLEARANCES

- 8.1 No temporary works shall encroach on the appropriate minimum clearances set out in the Manual for Track Maintenance (Document no. BBB0481):
- Drawing no. BE-97 Sheet 1: Horizontal Clearances: 1065mm gauge (Annexure 1 sheet 1)
 - Drawing no. BE-97 Sheet 2: Vertical Clearances: 1065mm gauge (Annexure 1 sheet 2)
 - Drawing no. BE-97 Sheet 3: Clearances: Platform (Annexure 1 sheet 3)
 - Drawing no. BE-97 Sheet 5: Clearances: 610mm Gauge (Annexure 1 sheet 5)

9.0 STACKING OF MATERIAL

- 9.1 The Contractor shall not stack any material closer than 3m from the centre line of any railway line without prior approval of the Contract Supervisor.

10.0 EXCAVATION, SHORING, DEWATERING AND DRAINAGE

- 10.1 Unless otherwise approved by the Contract Supervisor any excavation adjacent to a railway line shall not encroach on the hatched area shown in Figure 1.

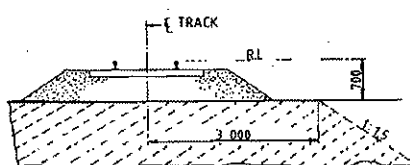

Fig. 1

- 10.2 The Contractor shall provide, at his own cost any shoring, dewatering or drainage of any excavation unless otherwise stipulated elsewhere in the Contract.
- 10.3 Where required by the Contract Supervisor, drawings of shoring for any excavation under or adjacent to a railway line shall be submitted and permission to proceed, obtained before the excavation is commenced.
- 10.4 The Contractor shall prevent ingress of water to the excavation but where water does enter, he shall dispose of it as directed by the Contract Supervisor.
- 10.5 The Contractor shall not block, obstruct or damage any existing drains either above or below ground level unless he has made adequate prior arrangements to deal with drainage.

11.0 FALSEWORK FOR STRUCTURES

- 11.1 Drawings of falsework for the construction of any structure over, under or adjacent to any railway line shall be submitted to the Contract Supervisor and his permission to proceed obtained before the falsework is erected. Each drawing shall be given a title and a distinguishing number and shall be signed by a registered professional engineer certifying that he has checked the design of the falsework and that the drawings are correct and in accordance with the design.
- 11.2 After the falsework has been erected and before any load is applied, the Contractor shall submit to the Contract Supervisor a certificate signed by a registered professional engineer certifying that he has checked the falsework and that it has been erected in accordance with the drawings. Titles and numbers of the drawings shall be stated in the certificate. Notwithstanding permission given by the Contract Supervisor to proceed, the Contractor shall be entirely responsible for the safety and adequacy of the falsework.

12.0 PILING

- 12.1 The Contract Supervisor will specify the conditions under which piles may be installed on the network operator's property.

13.0 UNDERGROUND SERVICES

- 13.1 No pegs or stakes shall be driven or any excavation made before the Contractor has established that there are no underground services which may be damaged thereby.
- 13.2 Any damage shall be reported immediately to the Contract Supervisor, or to the official in charge at the nearest station, or to the traffic controller in the case of centralised traffic control.

14.0 BLASTING AND USE OF EXPLOSIVES

- 14.1 When blasting within 500m of a railway line, the Contractor shall observe the requirements stipulated in this specification.
- 14.2 No blasting shall be carried out except with the prior written permission of the Contract Supervisor and under such conditions as he may impose.
- 14.3 On electrified lines the Contractor shall also obtain the permission of the Electrical Officer (Contracts) before blasting, and shall give at least 21 days notice of his intention to blast. No blasting shall be done in the vicinity of electrified lines unless a member of the network operator's electrical personnel is present.
- 14.4 The Contractor shall arrange for the supply, transport storage and use of explosives.
- 14.5 The Contractor shall have labour, tools and plant, to the satisfaction of the Contract Supervisor, available on the site to clear immediately any stones or debris deposited on the track or formation by blasting, and to repair any damage to the track or formation immediately after blasting. Repairs to the track shall be carried out only under the supervision of a duly authorised representative of the network operator.
- 14.6 The Contractor shall notify the Contract Supervisor of his intention to blast at least 21 days before the commencement of any blasting operations.
- 14.7 Before any blasting is undertaken, the Contractor and the Contract Supervisor shall jointly examine and measure up any buildings, houses or structures in the vicinity of the proposed blasting to establish the extent of any existing cracking or damage to such structures, etc. The Contractor, shall, subject to the provisions stipulated in the Contract Insurance Policy, make good any deterioration of such buildings, houses, or structures, which, in the opinion of the Contract Supervisor, was directly caused by the blasting.
- 14.8 After completion of the blasting the Contractor shall obtain a written clearance from each landowner in

the vicinity of the blasting operations to the effect that all claims for compensation in respect of damage caused by the blasting operations to their respective properties, have been settled.

14.9 The Contractor shall provide proof that he has complied with the provisions of clauses 10.17.1 to 10.17.4 of the Explosives Regulations (Act 26 of 1956 as amended).

14.10 Blasting within 500m of a railway line will only be permitted during intervals between trains. A person appointed by the Contract Supervisor, assisted by flagmen with the necessary protective equipment, will be in communication with the controlling railway station.

Only this person will be authorised to give the Contractor permission to blast, and the Contractor shall obey his instructions implicitly regarding the time during which blasting may take place.

14.11 The flagmen described in clause 14.10, where provided by the network operator, are for the protection of trains and the network operator's property only, and their presence does not relieve the Contractor in any manner of his responsibilities in terms of Explosives Act or Regulations, or any obligation in terms of this Contract.

14.12 The person described in clause 14.10 will record in a book provided and retained by the network operator, the dates and times:-

(i) when each request is made by him to the controlling station for permission to blast;

(ii) when blasting may take place;

(iii) when blasting actually takes place; and

(iv) when he advises the controlling station that the line is safe for the passage of trains.

14.13 Before each blast the Contractor shall record in the same book, the details of the blast to be carried out. The person appointed by the Contract Supervisor and the person who will do the blasting shall both sign the book whenever an entry described in clause 14.12 is made.

15.0 RAIL TROLLEYS

15.1 The use of rail trolleys or trestle trolleys on a railway line for working on high voltage equipment will be permitted only if approved by the Contract Supervisor and under the conditions stipulated by him.

15.2 All costs in connection with trolley working and any train protection services requested by the Contractor shall, be borne by the Contractor, unless otherwise agreed.

16.0 SIGNAL TRACK CIRCUITS

16.1 Where signal track circuits are installed, the Contractor shall ensure that no material capable of conducting an electrical current makes contact between rails of railway line/lines.

16.2 No signal connections on track-circuited tracks shall be severed without the Contract Supervisor's knowledge and consent.

17.0 PENALTY FOR DELAYS TO TRAINS

17.1 If any trains are delayed by the Contractor and the Contract Supervisor is satisfied that the delay was avoidable, a penalty will be imposed on the Contractor as stipulated in the contract, for the period and number of trains delayed.

18.0 SURVEY BEACONS AND PEGS

18.1 The Contractor shall not on any account move or damage any beacon, bench mark, reference mark, signal or trigonometrical station in the execution of the Works without the written approval of the Contract Supervisor.

Should the Contractor be responsible for any such occurrence, he shall report the circumstances to the Contract Supervisor who will arrange with the Director-General of Surveys for replacement of the beacon or mark at the cost of the Contractor.

18.2 The Contractor shall not move or damage any cadastral or mining beacon without the written approval of the Contract Supervisor and before it has been referenced by a registered land surveyor. Any old boundary beacon, which becomes an internal beacon on creation of new boundaries, shall not be moved without the written approval of the Contract Supervisor.

Should the Contractor move or damage any cadastral or mining beacon without authority, he shall be responsible for having it replaced, at his cost, by a land surveyor.

- 18.3 The Contractor shall preserve all pegs and bench marks. Such survey points shall not be removed without the written approval of the Contract Supervisor. Should any peg or benchmark be removed without authority, the Contract Supervisor will arrange for its replacement and the cost will be recovered from the Contractor. No claim will be considered for delay in replacing any such peg or bench mark. Each peg replaced shall be checked by the Contractor.
- 18.4 Where a new boundary has been established, beacons on the fence line shall not be disturbed, and fence posts or anchors may not be placed or excavations made within 0,6 m of any beacon without the prior written approval of the Contract Supervisor.

19.0 TEMPORARY LEVEL CROSSINGS

- 19.1 The Contract Supervisor may, on request of the Contractor, and if necessary for the purpose of execution of the Works, permit the construction of a temporary level crossing over a railway line at a position approved by the Contract Supervisor and at the Contractor's cost. The period for which the temporary level crossing is permitted will be at the discretion of the Contract Supervisor.

- 19.2 The Contractor will provide protection and supervise the construction of the road over the track(s) and within the railway servitude at the level crossing, as well as the erection of all road signs and height gauges. All cost to be borne by the applicant.

The Contractor shall exercise extreme caution in carrying out this work, especially in respect of damage to tracks, services, overhead power and communications routes and prevent contact with "live" overhead electrical equipment.

Unless otherwise agreed, the Contractor will provide the service deviations or alterations to the network operator's track-, structure-, drainage-, electrical-, telecommunications- and train authorisation systems to accommodate the level crossing.

- 19.3 The Contractor shall take all necessary steps including the provision of gates, locks and, where necessary, watchmen to restrict the use of the temporary level crossing to himself and his employees, his subcontractors and their employees, the staff of the network operator and to such other persons as the Contract Supervisor may permit and of whose identity the Contractor will be advised. If so ordered by the Contract Supervisor, the Contractor shall provide persons to control road traffic using the temporary level crossing. Such persons shall stop all road traffic when any approaching train is within seven hundred and fifty (750) metres of the temporary level crossing, and shall not allow road traffic to proceed over it until the lines are clear.

- 19.4 The Contractor shall maintain the temporary level crossing within the railway servitude in good condition for the period it is in use. A temporary agreement with the road authority to be concluded for the maintenance of the level crossing outside the railway servitude.

- 19.5 When the temporary level crossing is no longer required by the Contractor, or permitted by the network operator, the Contractor shall at his own cost remove it and restore the site and the network operator's track-, structure-, drainage-, electrical-, telecommunications- and train authorisation systems to its original condition. Work over the tracks and within the railway servitude will be supervised by the network operator.

20.0 COMPLETION OF THE WORKS

- 20.1 On completion of the works, the Contractor shall remove all the remaining construction plant and material from the site, other than material which is the property of the network operator, and leave the site in a clean, neat and tidy condition. If material and plant is required for the liability and maintenance period the Contract supervisor must authorise it's retention on site.

21.0 PROTECTION OF PERSONS AND PROPERTY

- 21.1 The Contractor shall provide and maintain all lights, guards, barriers, fencing and watchmen when and where necessary or as required by the Contract Supervisor or by any statutory authority, for the protection of the Works and for the safety and convenience of the public.

Red, yellow, green or blue lights may not be used by the Contractor as they can be mistaken for signals. Red, yellow, green or white flags shall only be used for protection by the Contractor. Within the precincts of a port the Contractor shall obtain the permission of the Port Captain before installing any light.

- 21.2 The Contractor shall take all the requisite measures and precautions during the course of the Works to:
- (i) protect the public and property of the public,
 - (ii) protect the property and workmen of both the network operator and the Contractor,
 - (iii) avoid damage to and prevent trespass on adjoining properties, and
 - (iv) ensure compliance with any instruction issued by the Contract Supervisor or other authorised person, and with any stipulation embodied in the contract documents which affects the safety of any person or thing.
- 21.3 The network operator will provide, at its own cost, protection for the safe working of trains during such operations as the Contract Supervisor may consider necessary. Protection by the network operator for any purpose whatsoever, does not absolve the Contractor of his responsibilities in terms of the Contract.
- 21.4 The Contractor shall take all precautions and appoint guards, watchmen and compound managers for prevention of disorder among and misconduct by the persons employed on the Works and by any other persons, whether employees or not, on the work site and for the preservation of the peace and protection of persons and property in the direct neighbourhood. Any relocation of camps because of disorder shall be at the Contractor's expense.
- 21.5 All operations necessary for the execution of the Works, including the provision of any temporary work and camping sites, shall be carried out so as not to cause veld fires, ground and environmental pollution, soil erosion or restriction of or interference with streams, furrows, drains and water supplies.
- If the original surface of the ground is disturbed in connection with the Works, it shall be made good by the Contractor to the satisfaction of the land owner, occupier or responsible authority.
- 21.6 The Contractor shall take all reasonable steps to minimise noise and disturbance when carrying out the Works, including work permitted outside normal working hours.
- 21.7 Dumping of waste or excess materials by the Contractor shall, in urban areas, be done under the direction and control of, and at sites made available by the local authority. Dumping outside local authority boundaries shall be done only with the express permission and under the direction and control of the Contract Supervisor.
- 21.8 The Contractor shall comply with environmental protection measures and specifications stipulated by the Contract Supervisor and/or local and environmental authorities.
- 22.0 INTERFERENCE WITH THE NETWORK OPERATOR'S ASSETS AND WORK ON OPEN LINES**
- 22.1 The Contractor shall not interfere in any manner whatsoever with an open line, nor shall he carry out any work or perform any act which affects the security, use or safety of an open line except with the authority of the Contract Supervisor and in the presence of a duly authorised representative of the network operator.
- 22.2 The Contractor shall not carry out any work or operate any plant, or place any material whatsoever nearer than three metres from the centre line of any open line except with the written permission of the Contract Supervisor and subject to such conditions as he may impose.
- 22.3 Care must be taken not to interfere with or damage any services such as overhead wire routes, cables or pipes and optical fibre cable, except as provided for the work specified. The Contractor will be held responsible for any damage to or interruption of such services arising from any act or omission on his part or of any of his employees, or persons engaged by him on the Works. The cost of repairing, replacing or restoring the services, as well as all other costs arising from any damage to services, shall be borne by, and will be recovered from the Contractor.
- 22.4 Authority granted by the Contract Supervisor and the presence of an authorised representative of the network operator in terms hereof, shall not relieve the Contractor of his duty to comply with this specification.
- 23.0 ACCESS, RIGHTS-OF-WAY AND CAMPSITES**
- 23.1 Where entry onto the network operator's property is restricted, permission to enter will be given only for the purpose of carrying out the Works and will be subject to the terms and conditions laid down by the network operator.
- 23.2 The Contractor shall arrange for campsites, workplaces and access thereto as well as for any right-of-

way over private property to the site of the Works, and for access within the boundaries of the network operator's property. The owners of private property to be traversed shall be approached and treated with tact and courtesy by the Contractor, who shall, if necessary, obtain a letter of introduction to such property owners from the Contract Supervisor.

The Contractor shall be responsible for the closing of all gates on roads and tracks used by him or his employees. Except with the prior approval of the Contract Supervisor and the owner or occupier of any private land to be traversed, the Contractor shall not cut, lower, damage, remove or otherwise interfere with any fence or gate which is either on the network operator's property or on private property and which restricts access to the Works. Where such approval has been given, the Contractor shall prevent entry of animals or unauthorised persons onto the network operator's or private property, and shall make the fences safe against trespass at the close of each day's work.

23.3 The Contractor shall take all reasonable steps to confine the movement of vehicles and plant to the approved right-of-way to minimise damage to property, crops and natural vegetation.

23.4 When access is no longer required, and before completion of the Works, the Contractor shall repair, restore or replace any fence or gate damaged during execution of the Works to the satisfaction of the Contract Supervisor and shall furnish the Contract Supervisor with a certificate signed by the owner and occupier of land over which he has gained access to a campsite, workplace and the Works, certifying that the owner and occupier have no claim against the Contractor or the network operator arising from the Contractor's use of the land. Should the Contractor be unable to obtain the required certificate, he shall report the circumstances to the Contract Supervisor.

24.0 SUPERVISION

24.1 The Contract Supervisor will provide overall technical superintendence of the Works, and may direct the Contractor in terms of the provisions of the Contract or in respect of any measures which the Contract Supervisor may require for the operations of the network operator, the safety of trains, property and workmen of the network operator, and for the safety of other property and persons. The Contractor shall carry out the directions of the Contract Supervisor. The superintendence exercised by the Contract Supervisor, including any agreement, approval, refusal or withdrawal of any approval given, shall not relieve the Contractor of any of his duties and liabilities under the Contract, and shall not imply any assumption by the network operator or by the Contract Supervisor of the legal and other responsibilities of the Contractor in carrying out the Works.

24.2 The Contract Supervisor may delegate to any deputy or other person, any of his duties or functions under the Contract. On receiving notice in writing of such delegation, the Contractor shall recognise and obey the deputy or person to whom any such duties or functions have been delegated as if he were the Contract Supervisor.

24.3 The Contractor shall exercise supervision over the Works at all times when work is performed or shall be represented by an agent having full power and authority to act on behalf of the Contractor. Such agent shall be competent and responsible, and have adequate experience in carrying out work of a similar nature to the Works, and shall exercise personal supervision on behalf of the Contractor. The Contract Supervisor shall be notified in writing of such appointment which will be subject to his approval.

24.4 The Contractor or his duly authorised agent shall be available on the site at all times while the Works are in progress to receive the orders and directions of the Contract Supervisor.

25.0 HOUSING OF EMPLOYEES

25.1 The Contractor shall, where necessary, make his own arrangements for suitable housing of his employees. Where temporary housing is permitted by the Contract Supervisor on any part of the site, the Contractor shall provide suitable sanitation, lighting and potable water supplies in terms of the requirements of the local authority or the current network operator's specification; Minimum Communal Health Requirements in Areas outside the Jurisdiction of a Local Authority - E.4B, as applicable.

25.2 Fouling the area inside or outside the network operator's boundaries shall be prevented. The Contractor will be called upon by the Contract Supervisor to dispose of any foul or waste matter generated by the Contractor.

26.0 OPTICAL FIBRE CABLE ROUTES

26.1 The Contractor shall not handle, impact, move or deviate any optical fibre cable without prior approval.

26.2 Works that in any way affect the optical fibre cable requires prior approval from the Contract Supervisor

who will determine the work method and procedures to be followed.

"PREVIEW COPY ONLY"

PART B - SPECIFICATION FOR WORK NEAR HIGH-VOLTAGE ELECTRICAL EQUIPMENT

27.0 GENERAL

27.1 This specification is based on the contents of Transnet's publication ELECTRICAL SAFETY INSTRUCTIONS, as amended, a copy of which will be made available on loan to the Contractor for the duration of the contract.

These instructions apply to all work near "live" high-voltage equipment maintained and/or operated by the network operator, and the onus rests on the Contractor to ensure that he obtains a copy.

27.2 This specification must be read in conjunction with and not in lieu of the Electrical Safety Instructions.

27.3 The Contractor's attention is drawn in particular to the contents of Part I, Sections 1 and 2 of the Electrical Safety Instructions.

27.4 The Electrical Safety Instructions cover the minimum safety precautions which must be taken to ensure safe working on or near high-voltage electrical equipment, and must be observed at all times. Should additional safety measures be considered necessary because of peculiar local conditions, these may be ordered by and at the discretion of the Electrical Officer (Contracts).

27.5 The Contractor shall obtain the approval of the Electrical Officer (Contracts) before any work is done which causes or could cause any portion of a person's body or the tools he is using or any equipment he is handling, to come within 3 metres of any "live" high-voltage equipment.

27.6 The Contractor shall regard all high-voltage equipment as "live" unless a work permit is in force.

27.7 Safety precautions taken or barriers erected shall comply with the requirements of the Electrical Officer (Contracts), and shall be approved by him before the work to be protected is undertaken by the Contractor. The Contractor shall unless otherwise agreed, bear the cost of the provision of the barriers and other safety precautions required, including the attendance of the network operator's staff where this is necessary.

27.8 No barrier shall be removed unless authorised by the Electrical Officer (Contracts).

28.0 WORK ON BUILDINGS OR FIXED STRUCTURES

28.1 Before any work is carried out or measurements are taken on any part of a building, fixed structure or earthworks of any kind above ground level situated within 3 metres of "live" high-voltage equipment, the Electrical Officer (Contracts) shall be consulted to ascertain the conditions under which the work may be carried out.

28.2 No barrier erected to comply with the requirements of the Electrical Officer (Contracts) shall be used as temporary staging or shuttering for any part of the Works.

28.3 The shuttering for bridge piers, abutments, retaining walls or parapets adjacent to or over any track may be permitted to serve as a barrier, provided that it extends at least 2,5 metres above any working level in the case of piers, abutments and retaining walls and 1,5 metres above any working level in the case of parapets.

29.0 WORK DONE ON OR OUTSIDE OF ROLLING STOCK, INCLUDING LOADING OR UNLOADING

29.1 No person may stand, climb or work, whilst on any platform, surface or foothold:

29.1.1 higher than the normal unrestricted access way, namely -

29.1.1.1 external walkways on diesel, steam and electric locomotives, steam heat vans, etc. and

29.1.1.2 walkways between coaches and locomotives.

29.1.2 of restricted access ways in terms of the Electrical Safety Instructions namely -

29.1.2.1 the floor level of open wagons

29.1.2.2 external walkways or decks of road-rail vehicles, on-track maintenance machines and material trains.

29.1.3 Unauthorised staff working on these platforms must be directly supervised by duly authorised persons in terms of clause 607.1.3 of the Electrical Safety Instructions. These persons must attend the relevant electrical safety module training. A letter of training must then be issued by an accredited training authority. A Category C Certificate of Authority must be obtained from the

local depot examining officer.

- 29.2 When in the above positions no person may raise his hands or any equipment he is handling above his head.
- 29.3 In cases where the Contractor operates his own rail mounted equipment, he shall arrange for the walkways on this plant to be inspected by the Electrical Officer (Contracts) and approved, before commencement of work.
- 29.4 The handling of long lengths of material such as metal pipes, reinforcing bars, etc should be avoided, but if essential they shall be handled as nearly as possible in a horizontal position below head height.
- 29.5 The Responsible Representative shall warn all persons under his control of the danger of being near "live" high-voltage equipment, and shall ensure that the warning is fully understood.
- 29.6 Where the conditions in clauses 30.1 to 30.4 cannot be observed the Electrical Officer (Contracts), shall be notified. He will arrange for suitable Safety measures to be taken. The Electrical Officer (Contracts), may in his discretion and in appropriate circumstances, arrange for a suitable employee of the Contractor to be specially trained by the network operator and at the Contractor's cost, as an Authorised Person to work closer than 3 metres from "live" overhead conductors and under such conditions as may be imposed by the senior responsible electrical engineer of the network operator.

30.0 USE OF EQUIPMENT

30.1 Measuring Tapes and Devices

- 30.1.1 Measuring tapes may be used near "live" high-voltage equipment provided that no part of any tape or a person's body comes within 3 metres of the "live" equipment.
- 30.1.2 In windy conditions the distance shall be increased to ensure that if the tape should fall it will not be blown nearer than 3 metres from the "live" high-voltage equipment.
- 30.1.3 Special measuring devices longer than 2 metres such as survey sticks and rods may be used if these are of non-conducting material and approved by the responsible Electrical Engineer of the network operator, but these devices must not be used within 3 metres of "live" high-voltage equipment in rainy or wet conditions.
- 30.1.4 The assistance of the Electrical Officer (Contracts) shall be requested when measurements within the limits defined in clauses 31.1.1 to 31.1.3 are required.
- 30.1.5 The restrictions described in 31.1.1 to 31.1.3 do not apply on a bridge deck between permanent parapets nor in other situations where a barrier effectively prevents contact with the "live" high-voltage equipment.

30.2 Portable Ladders

- 30.2.1 Any type of portable ladder longer than 2 metres may only be used near "live" high-voltage equipment under the direct supervision of the Responsible Representative. He shall ensure that the ladder is always used in such a manner that the distance from the base of the ladder to any "live" high-voltage equipment is greater than the fully extended length of the ladder plus 3 metres. Where these conditions cannot be observed, the Electrical Officer (Contracts) shall be advised, and he will arrange for suitable safety measures to be taken.

31.0 CARRYING AND HANDLING MATERIAL AND EQUIPMENT

- 31.1 Pipes, scaffolding, iron sheets, reinforcing bars and other material which exceeds 2 metres in length shall be carried completely below head height near "live" high-voltage equipment. For maximum safety such material should be carried by two or more persons so as to maintain it as nearly as possible in a horizontal position. The utmost care must be taken to ensure that no part of the material comes within 3 metres of any "live" high-voltage equipment.
- 31.2 Long lengths of wire or cable shall never be run out in conditions where a part of a wire or cable can come within 3 metres of any "live" high-voltage equipment unless the Electrical Officer (Contracts) has been advised and has approved appropriate safety precautions.
- 31.3 The presence of overhead power lines shall always be taken account of especially when communications lines or cables or aerial cables, stay wires, etc. are being erected above ground level.

32.0 PRECAUTIONS TO BE TAKEN WHEN ERECTING OR REMOVING POLES, ANTENNAE, TREES ETC.

- 32.1 A pole may be handled for the purpose of erection or removal near high-voltage equipment under the following conditions:

(i) If the distance between the point at which the pole is to be erected or removed and the nearest "live" high-voltage equipment is more than the length of the pole plus 3 metres, the work shall be supervised by the Responsible Representative.

(ii) If the distance described in (i) is less than the length of the pole plus 3 metres, the Electrical Officer (Contracts) shall be consulted to arrange for an Authorised Person to supervise the work and to ensure that the pole is earthed where possible. The pole shall be kept in contact with the point of erection, and adequate precautions shall be taken to prevent contact with "live" high-voltage equipment.

32.2 The cost of supervision by an Authorised Person and the provision of earthing shall, unless otherwise agreed, be borne by the Contractor.

32.3 The provisions of clauses 33.1 and 33.2 shall also apply to the erection or removal of columns, antennae, trees, posts, etc.

33.0 USE OF WATER

33.1 No water shall be used in the form of a jet if it can make contact with any "live" high-voltage equipment or with any person working on such equipment.

34.0 USE OF CONSTRUCTION PLANT

34.1 "Construction plant" entails all types of plant including cranes, piling frames, boring machines, excavators, draglines, dewatering equipment and road vehicles with or without lifting equipment.

34.2 When work is being undertaken in such a position that it is possible for construction plant or its load to come within 3 metres of "live" high-voltage equipment, the Electrical Officer (Contracts) shall be consulted. He will arrange for an Authorised Person to supervise the work and to ensure that the plant is adequately earthed. The Electrical Officer (Contracts) will decide whether further safety measures are necessary.

34.3 The cost of any supervision by an Authorised Person and the provision of earthing shall, unless otherwise agreed, be borne by the Contractor.

34.4 When loads are handled by cranes, non-metallic rope hand lines shall be used, affixed to such loads so as to prevent their swinging and coming within 3 metres of "live" high-voltage equipment.

34.5 Clauses 35.1 to 35.4 shall apply *mutatis mutandis* to the use of maintenance machines of any nature.

35.0 WORK PERFORMED UNDER DEAD CONDITIONS UNDER COVER OF A WORK PERMIT

35.1 If the Responsible Representative finds that the work cannot be done in safety with the high-voltage electrical equipment "live", he shall consult the Electrical Officer (Contracts) who will decide on the action to be taken.

35.2 If a work permit is issued the Responsible Representative shall-

(i) before commencement of work ensure that the limits within which work may be carried out have been explained to him by the Authorised Person who issued the permit to him, and that he fully understands these limits.

(ii) sign portion C of the permit before commencement of work;

(iii) explain to all persons under his control the limits within which work may be carried out, and ensure that they fully understand these limits;

(iv) care for the safety of all persons under his control whilst work is in progress; and

(v) withdraw all personnel under his control from the equipment on completion of the work before he signs portion D of the work permit.

36.0 TRACTION RETURN CIRCUITS IN RAILS

36.1 DANGEROUS CONDITIONS CAN BE CREATED BY REMOVING OR SEVERING ANY BOND.

36.2 Broken rails with an air gap between the ends, and joints at which fishplates are removed under "broken bond" conditions, are potentially lethal. The rails on either side of an air gap between rail ends on electrified lines shall not be touched simultaneously until rendered safe by the network operator personnel.

36.3 The Contractor shall not break any permanent bonds between rails or between rails and any structure. He shall give the Contract Supervisor at least 7 days written notice when removal of such bonds is necessary.

36.4 No work on the track which involves interference with the traction return rail circuit either by cutting or removing the rails, or by removal of bonds shall be done unless the Electrical Officer (Contracts) is consulted. He will take such precautions as may be necessary to ensure continuity of the return circuit before permitting the work to be commenced.

37.0 HIGH-VOLTAGE ELECTRICAL EQUIPMENT NOT MAINTAINED AND/OR OPERATED BY THE NETWORK OPERATOR

Where the work is undertaken on or near high-voltage electrical equipment which is not maintained and/or operated by the network operator, the Occupational Health and Safety Act No. 85 of 1993, and Regulations and Instructions, or the Mines Health and Safety Act (Act 29 of 1996), shall apply.

Such equipment includes:-

- (i) Eskom and municipal equipment;
- (ii) The Contractor's own power supplies; and
- (iii) Electrical equipment being installed but not yet taken over from the Contractor.

END

"PREVIEW COPY ONLY"

HORIZONTAL CLEARANCES :
1 065mm TRACK GAUGE

ANNEXURE 1
SHEET 1 of 5



RADIUS (m)	WITH CANT		NO CANT	
	H (mm)	L (mm)	H & L	C (mm)
90	2 730	3 090	2 780	2 100
100	2 700	3 030	2 750	2 050
120	2 650	2 970	2 700	2 000
140	2 620	2 920	2 660	1 950
170	2 590	2 870	2 630	1 900
200	2 570	2 820	2 600	1 950
250	2 550	2 790	2 580	1 920
300	2 540	2 760	2 560	1 900
350	2 530	2 730	2 540	1 890
400	2 520	2 710	2 530	1 875
500	2 510	2 680	2 520	1 850
600	2 500	2 660	2 510	1 830
800	2 490	2 620	2 500	1 790
1 000	2 480	2 600	2 490	1 760
1 200	2 480	2 580	2 490	1 730
1 500	2 480	2 550	2 480	1 700
2 000	2 480	2 500	2 480	1 660
3 000	2 470	2 470	2 470	1 600
>5 000	2 460	2 460	2 460	1 600

REMARKS:

1. H AND B IS THE REQUIRED HORIZONTAL CLEARANCE ON THE HIGH LEG OF THE CURVE BASED ON MINIMUM CANT.
2. L AND C IS THE REQUIRED HORIZONTAL CLEARANCE ON THE LOW LEG OF THE CURVE BASED ON MAXIMUM CANT.
3. INTERMEDIATE VALUES MAY BE INTERPOLATED BY THE ENGINEER IN CHARGE.
4. FOR WORKSHOP AREAS AND TEMPORARY WORK, CLEARANCES AND L MAY BE REDUCED BY 300mm.
5. SEE ANNEXURE 1 SHEET 3 FOR PLATFORM CLEARANCES. H
6. ALSO REFER TO REMARKS 4 TO 8 OF ANNEXURE 1 SHEET 2.
7. USE SMALLER RADIUS IF RADIUS IN BETWEEN

VERTICAL CLEARANCES :
1 065mm TRACK GAUGE

ANNEXURE 1
SHEET 2 of 5

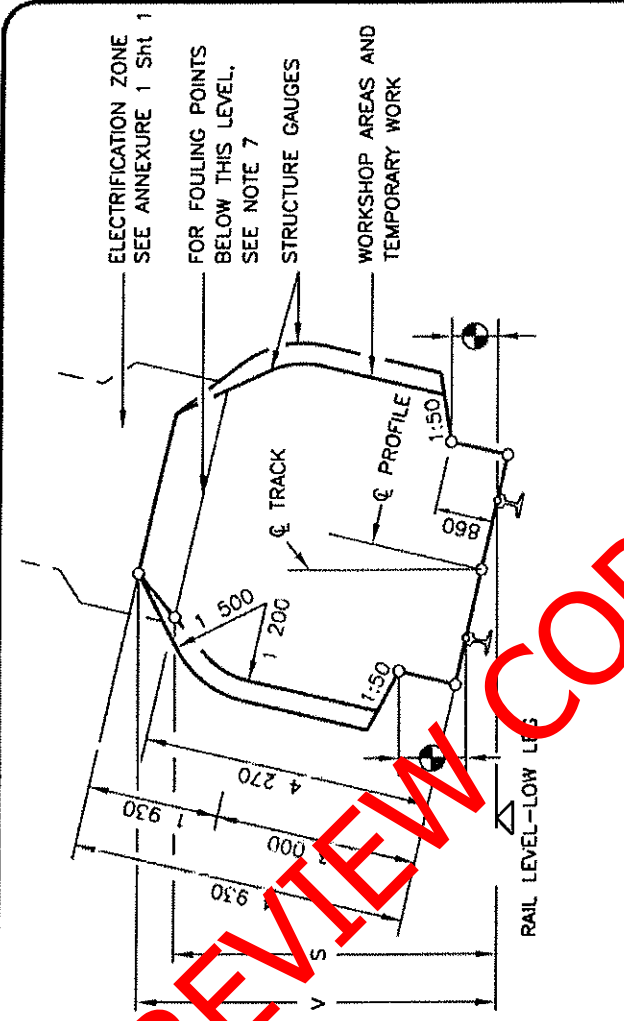

LOCATION	NOT ELECTRIFIED		ELECTRIFIED (PRESENT OR FUTURE)	
	RADIUS (mm)	S (mm)	V (mm)	3kV & 25kV (mm)
* BELOW ALL AREAS OTHER THAN THOSE INDICATED BY * OVER OR NEAR POINTS AND CROSSING IF REQUIRED BY ELECTRICAL IRRESPECTIVE OF RADIUS	100	4 470	5 050	5 400
	300	4 410	5 020	5 370
	600	4 370	5 000	5 350
	1 000	4 350	4 990	5 340
	1 500	4 310	4 960	5 310
	2 000	4 290	4 940	5 290
	>3 000	4 270	4 930	5 280
		5 650	6 000	

REMARKS:

- V IS THE REQUIRED VERTICAL CLEARANCE EXCEPT WHERE REDUCED CLEARANCE S APPLIES.
- S IS THE MINIMUM VERTICAL CLEARANCE FOR STRUCTURES AND TEMPORARY WORK OVER NON-ELECTRIFIED LINES.
- INTERMEDIATE VALUES MAY BE INTERPOLATED BY THE ENGINEER IN CHARGE.
- FOR APPLICATION AT CURVES
 - APPLY INCREASED CLEARANCES FOR CURVES TO POINTS 3m BEYOND THE ENDS OF THE CIRCULAR CURVE.
 - REDUCE CLEARANCES AT A UNIFORM RATE OVER THE REMAINDER OF THE TRANSITION CURVE.
 - FOR NON-TRANSITIONED CURVES REDUCE AT A UNIFORM RATE OVER A LENGTH OF 15m ALONG STRAIGHTS.
- NEW STRUCTURES: SEE BRIDGE CODE.
- TUNNELS: SEE DRAWING BE 82-35.
- FOULING POINTS: SEE CLAUSE 8.1.
- CLEARANCES ARE BASED ON 15m BOGIE CENTRES AND 21.2m VEHICLE BODY LENGTH.
- SEE ANNEXURE 1 SHEET 3 FOR PLATFORM CLEARANCES.

CLEARANCES : PLATFORMS

ANNEXURE 1
SHEET 3 of 5

PLATFORMS : TRACK GAUGE 1 065mm

PASSENGERS

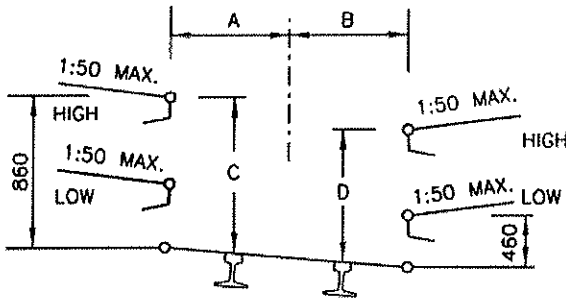

GOODS

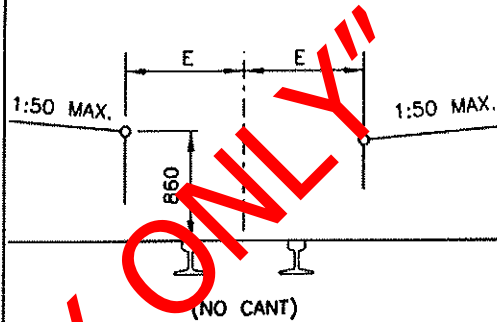

RADIUS (m)	A (mm)	B (mm)	C (mm)	D (mm)	E (mm)
90	1 690	1 820	890	810	1 840
100	1 650	1 790	890	810	1 810
120	1 610	1 740	890	810	1 760
140	1 580	1 700	890	810	1 720
170	1 550	1 660	890	810	1 690
200	1 530	1 630	890	820	1 670
250	1 520	1 600	890	820	1 640
300	1 520	1 570	890	830	1 620
350	1 520	1 560	880	830	1 600
400	1 520	1 550	880	840	1 590
500	1 520	1 540	880	850	1 580
600	1 520	1 530	870	850	1 570
800	1 520	1 520	860	860	1 560
1 200	1 520	1 520	860	860	1 550
2 000	1 520	1 520	860	860	1 540
3 000	1 520	1 520	860	860	1 530
STRAIGHT	1 520	1 520	860	860	1 520

REMARKS:

1. NO CANT TO BE APPLIED EXCEPT WHEN THE GOODS PLATFORM IS ON A RUNNING LINE.
2. INTERMEDIATE VALUES MAY BE INTERPOLATED BY THE ENGINEER IN CHARGE.
3. 8m TO MAIN STATION-BUILDINGS AND 3m TO ALL OTHER STRUCTURES.
4. TOLERANCES : SEE CLAUSE 8.0.10.
5. ALWAYS USE THE SMALLEST RADIUS

STRUCTURES ON PLATFORMS : 1 065mm AND 610mm TRACK GAUGE

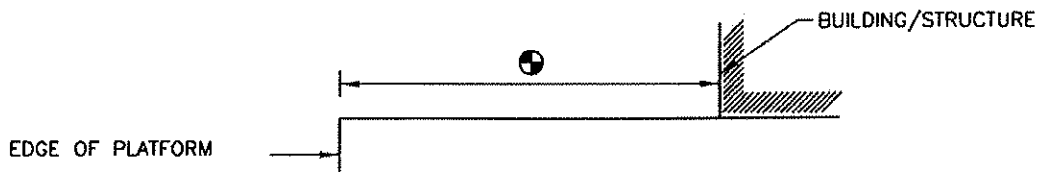

CLEARANCES : 610mm TRACK GAUGE

ANNEXURE 1
SHEET 5 of 5

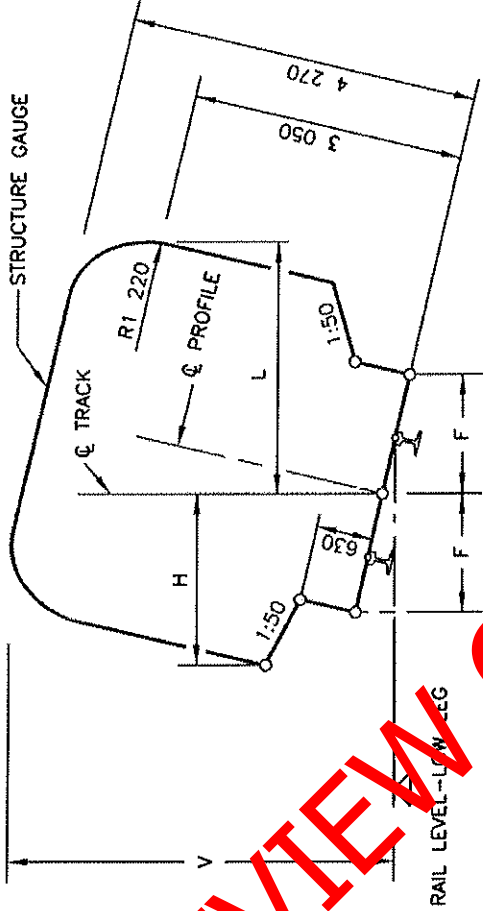

RADIUS (m)	F (mm)
50	1 550
60	1 510
80	1 460
100	1 430
120	1 410
140	1 390
170	1 380
200	1 370
250	1 360
300	1 350
500	1 330
1 000	1 320
>2 000	1 320
STRAIGHT	1 310

RADIUS (m)	WITH CANT		NO CANT	V (mm)
	H (mm)	L (mm)	H & L (mm)	
50	2 370	2 490	2 400	4 320
70	2 310	2 420	2 330	4 310
100	2 260	2 370	2 280	4 310
140	2 220	2 340	2 250	4 310
200	2 200	2 300	2 220	4 300
300	2 190	2 270	2 200	4 300
500	2 180	2 230	2 190	4 290
700	2 170	2 200	2 180	4 270
1 000	2 170	2 170	2 170	4 270
>2 000	2 160	2 160	2 160	4 270

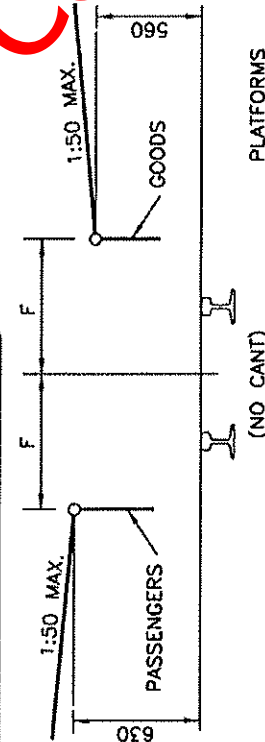

REMARKS:

- H IS THE MINIMUM HORIZONTAL CLEARANCE ON THE OUTSIDE OF THE CURVE BASED ON MINIMUM CANT.
- L IS THE MINIMUM HORIZONTAL CLEARANCE ON THE INSIDE OF THE CURVE BASED ON MAXIMUM CANT.
- V IS THE MINIMUM VERTICAL CLEARANCE.
- FOR APPLICATION AT CURVES:
 - 1 APPLY INCREASED CLEARANCES FOR CURVES TO POINTS 2m BEYOND THE ENDS OF THE CIRCULAR CURVE.
 - 2 REDUCE CLEARANCES AT A UNIFORM RATE OVER THE REMAINDER OF THE TRANSITION CURVE.
 - 3 FOR NON-TRANSITIONED CURVES REDUCE AT A UNIFORM RATE OVER A LENGTH OF 18m ALONG STRAIGHTS.
- INTERMEDIATE VALUES MAY BE INTERPOLATED BY THE ENGINEER IN CHARGE.
- ALSO REFER TO REMARKS 5, 6 AND 7 OF ANNEXURE 1 SHEET 2.
- CLEARANCES ARE BASED ON 9 700mm BOGIE CENTRES AND 13 700mm VEHICLE BODY LENGTH.
- SEE ANNEXURE 1 SHEET 3 FOR STRUCTURES ON PLATFORMS.