

30kg/m

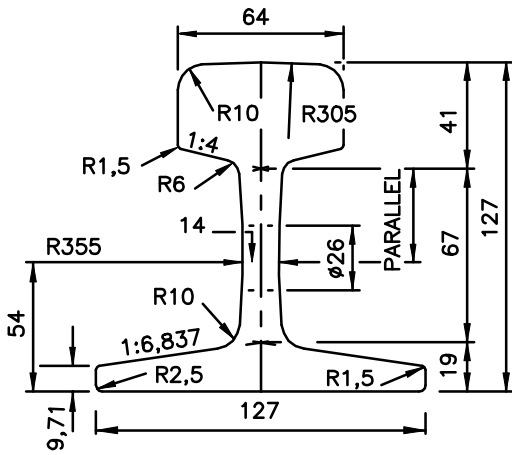

40kg/m

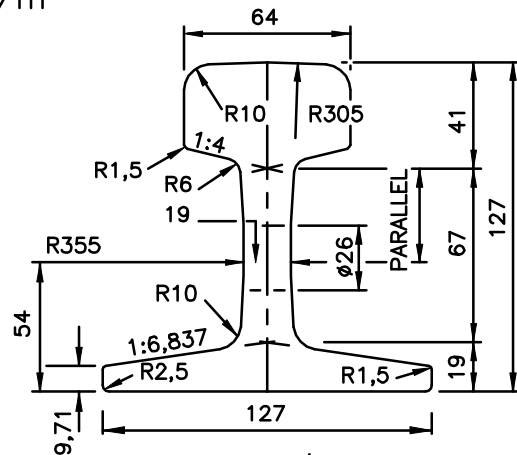

43kg/m
(HARBOUR AREAS)

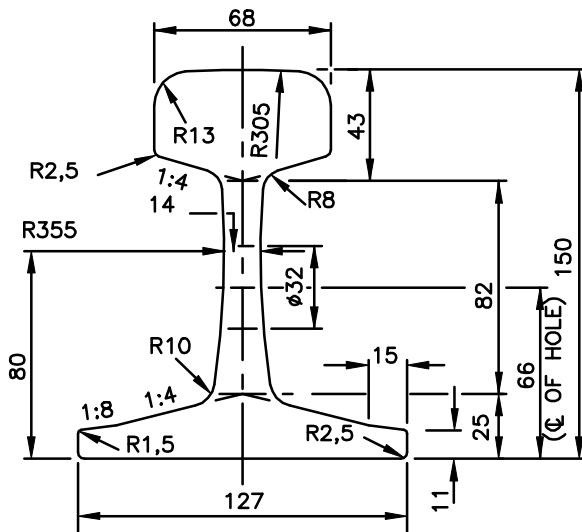

48kg/m

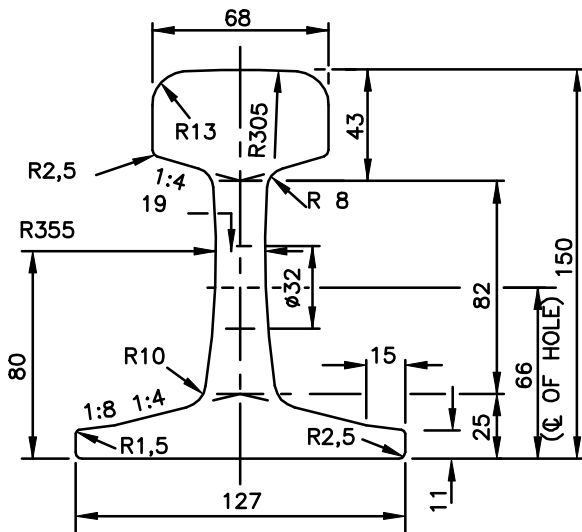

51kg/m
(FLEXIBLE POINTS BLADE
AND UNDERCUT STOCK RAIL)

REMARKS :
1. FOR PROPERTIES AND ROLL MARKS SEE
ANNEXURE 14 SHEETS 4 TO 6

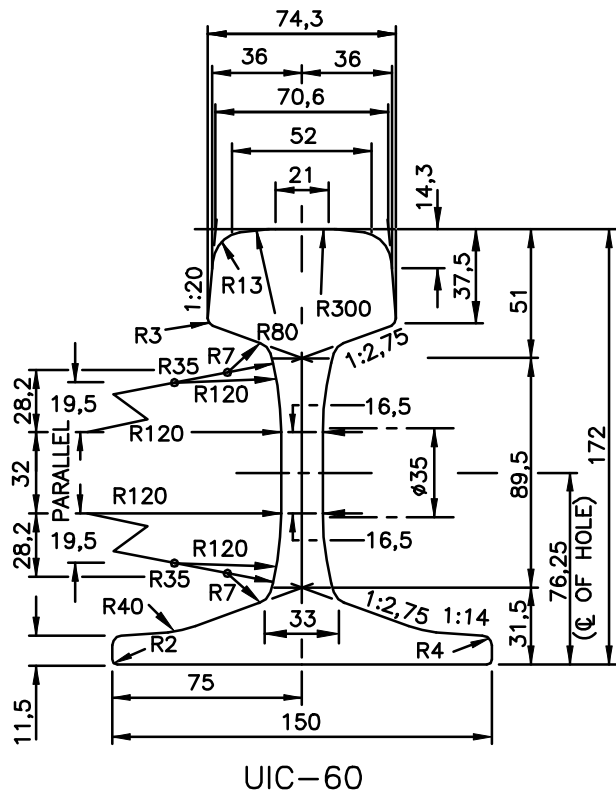
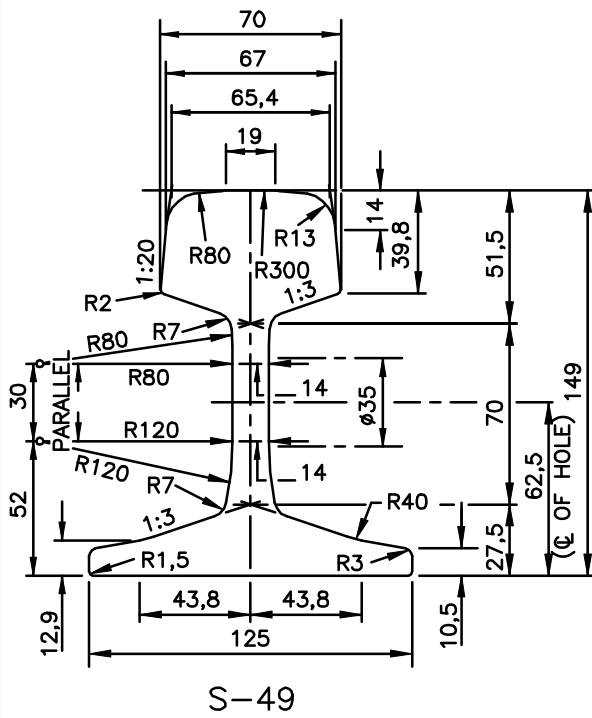
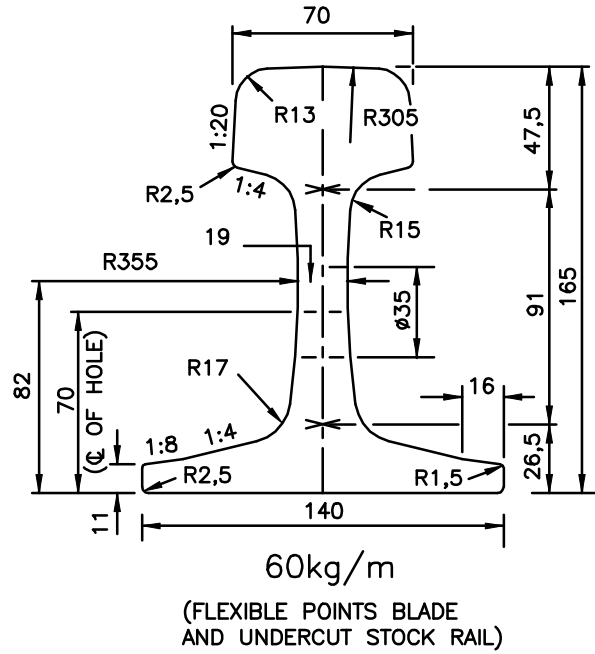
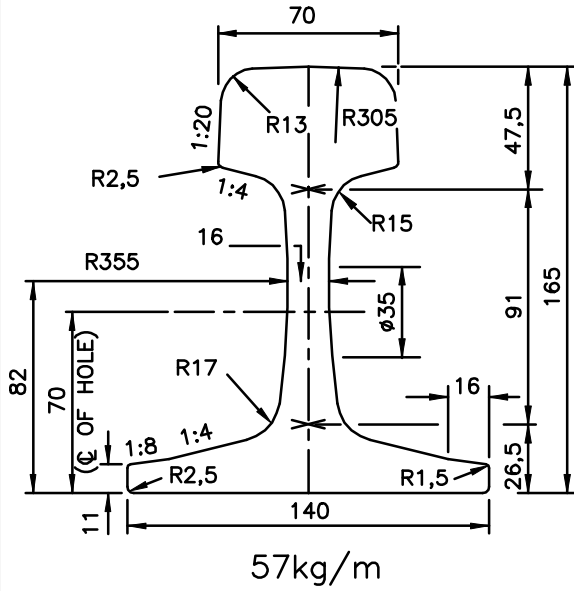

REMARKS :
1. FOR PROPERTIES AND ROLL MARKS SEE
ANNEXURE 14 SHEETS 4 TO 6

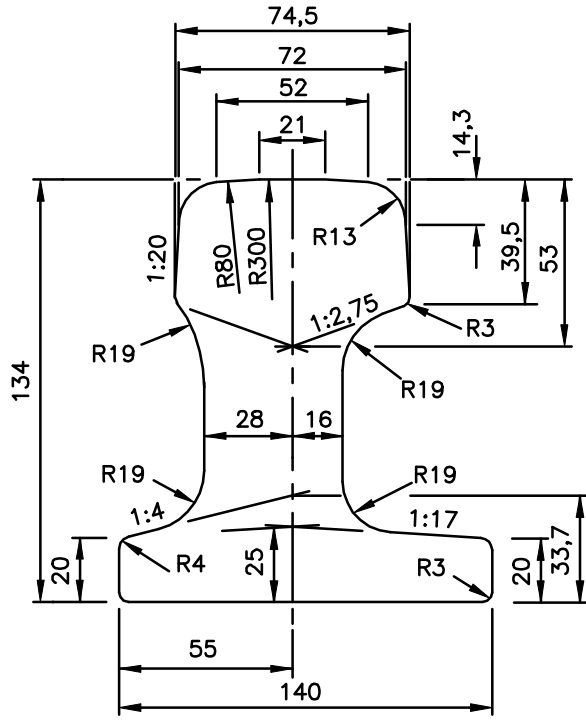

Zu-1-60

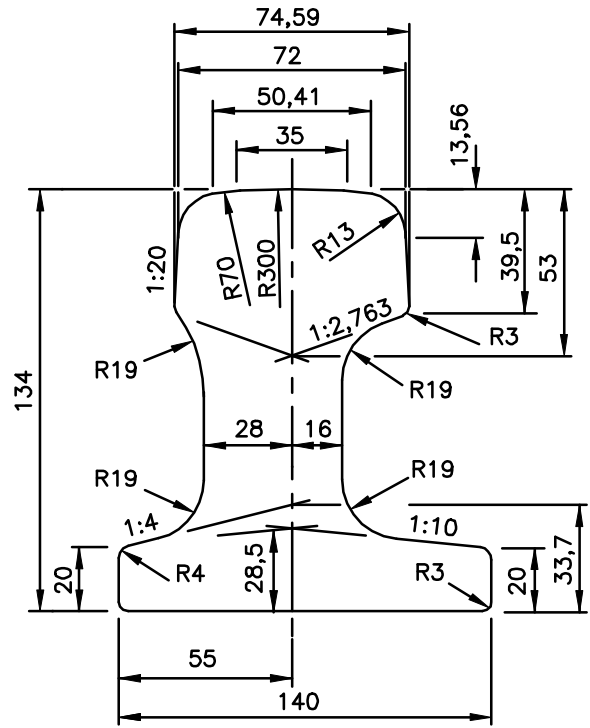

Z-S60-SAR

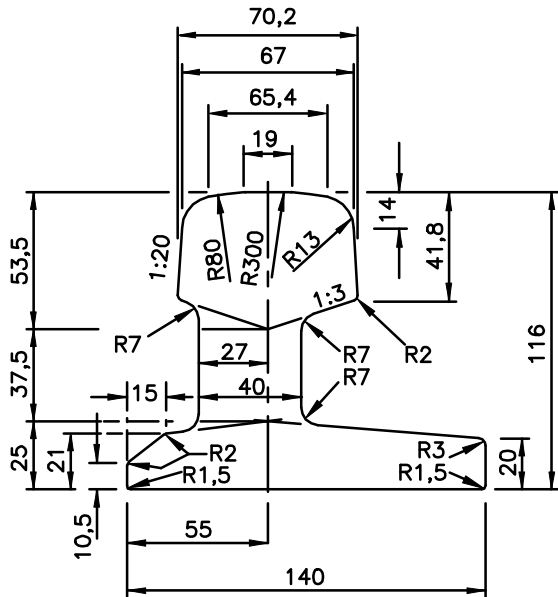

Zu-2-49

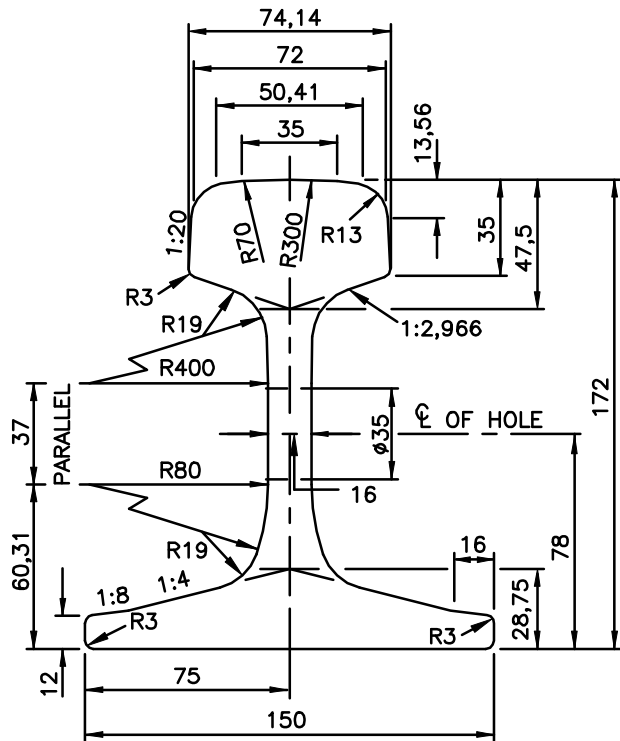

S-60-SAR

REMARKS :

1. FOR PROPERTIES AND ROLL MARKS SEE ANNEXURE 14 SHEETS 4 TO 6

RAIL PROPERTIES

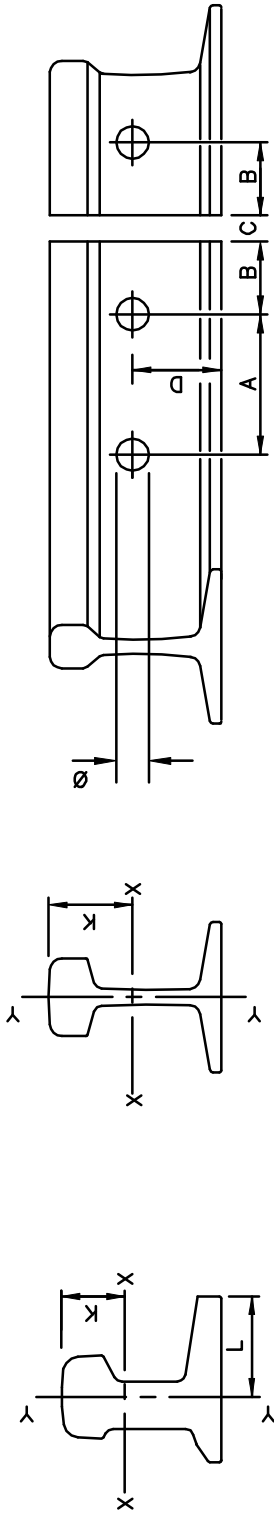

RAIL	MASS (kg/m)	HOLING						AREAS				PROPERTIES				DRAWING
		A	B	C	D	Ø	NUMBER	HEAD (%)	WEB (%)	FLANGE (%)	SECTION (cm ²)	I (cm ⁴)	Z (cm ³)	K (mm)	L (mm)	
		X	Y	X	X	X	X - Y	Y - Y								
30kg		100	47	6	46	26	4	45,11	18,87	36,02	38,537	626,89	110,94	56,36	-	E-192M
40kg		100	47	6	54	26	4	44,86	19,44	35,70	51,715	1 115,38	169,20	65,92	-	E-346
43kg		100	47	6	54	26	4	42,42	24,03	33,55	55,230	1 129,00	170,10	66,35	-	E-3215M
48kg		100	67	6	66	32	4	41,55	22,65	35,80	60,180	1 822,00	234,18	78,50	-	E-358M
51kg		100	67	6	66	32	4	39,00	27,80	33,20	64,850	1 844,00	234,60	78,60	-	E-358M
57kg		100	67	6	70	35	4	41,55	23,02	35,43	73,240	2 650,80	336,46	86,21	-	E-3232M
60kg		100	67	6	70	35	4	40,14	25,69	34,17	76,125	2 703,27	343,97	86,41	-	E-3232M
S-60-SAR	60,34	100	67	6	78	35	4	37,53	24,02	38,45	77,020	3 097,82	395,63	93,70	-	E-3326
Z-S60-SAR	72,83	-	-	-	-	-	-	34,88	30,63	34,47	92,980	1 734,40	292,98	74,80	82,70	
UIC-60	60,34	100	67	6	76,25	35	4	40,22	22,55	37,23	76,860	3 055,00	335,50	91,05	-	700-E-736
Zu-l-60	73,00	-	-	-	-	-	-	-	-	-	93,000	1 728,00	229,90	75,15	82,24	
S-49	49,43	100	67	6	62,5	35	4	47,45	17,56	34,99	62,970	1 189,00	240,00	75,70	-	700-E-722
Zu-2-49	62,20	-	-	-	-	-	-	-	-	-	79,260	1 075,00	162,00	66,30	81,00	

ROLL MARKS ON RAILS

H.C.O.B. RAILS

	<	NOMINAL MASS		9	19 _ _	SAR	
	<	NOMINAL MASS	2MCC	9	19 _ _	SAS	
	<	NOMINAL MASS		ž	9	19 _ _	SAR
	<	NOMINAL MASS			9	19 _ _	SAS
	<	NOMINAL MASS	2MCC	ž	9	19 _ _	SAR
	<	NOMINAL MASS	2MCC	Z	9	19 _ _	SAS
	<	NOMINAL MASS		Z	9	19 _ _	SAR
	<	NOMINAL MASS		Z	9	19 _ _	SAS

UIC A RAILS

	<	NOMINAL MASS		9	19 _ _	SAR	
	<	NOMINAL MASS		ž	9	19 _ _	SAS

UIC B RAILS

	<	NOMINAL MASS		9	19 _ _	SAR
--	---	--------------	--	---	--------	-----

UIC C RAILS

	<	NOMINAL MASS	2MCC	9	19 _ _	SAS	
	<	NOMINAL MASS	2MCC	ž	9	19 _ _	SAR
	<	NOMINAL MASS		9	19 _ _	SAS	

Cr-Mn RAILS

	<	NOMINAL MASS		9	19 _ _	SAR
	<	NOMINAL MASS	KRUPP		19 _ _	SAS

ROLL MARKS ON RAILS

HEAD HARDENED RAILS				
DO	96	1X	UIC 60	— —
THYSSEN			UIC 60	HH 350
THYSSEN			UIC 60	HHLA 350
HY	96	X	UIC 60	□ ≡
HY	96	X	UIC 60	□ ≡
UIC 60	LDVT			
UIC 60	LD	NKK	THH	TH34*
UIC 60	LD	NKK	THH	TH37*

REMARKS :

- * HOT STAMPED ON OTHER SIDE
- * MANUFACTURER'S MARK MAY NOT BE PRESENT ON HEAD HARDENED RAILS